



PRO24





Amorebieta 01.02.2024

Estimados clientes, colaboradores y amigos,
Con este catálogo IZAR PROFESIONAL 2024 les presentamos la más amplia gama de referencias de nuestra historia.

En esta edición incluimos cerca de 10.000 artículos de los cuales queremos destacar varios nuevos productos:

En primer lugar, la broca multipropósito 1876 con punta de metal duro, afilado exclusivo IZAR y tratamiento superficial IZAR BLUE. Dicha broca es apta para trabajos en ladrillo refractario, cerámicas o porcelánicos blandos, metal, maderas duras, plásticos e incluso para el hormigón con percusión.

También resaltamos nuestra nueva broca de pared 1821 con cuatro cuchillas de metal duro en la punta y planos de arrastre en el mango para garantizar la máxima eficiencia en las condiciones más exigentes con taladro convencional.

Asimismo, les ofrecemos una gama de mango hexagonal para realizar trabajos con atornillador de impacto que incluye herramientas para el taladrado en metal, madera o construcción, roscado, avellanado y atornillado, siempre con los más altos estándares de calidad IZAR.

Hemos realizado un gran esfuerzo en desarrollar nuevas capacidades y ampliar nuestra propuesta técnica para dar con las soluciones de corte más apropiadas para un mercado cada vez más exigente. Esta apuesta por el valor añadido de nuestra gama y servicio ha sido nuevamente reconocida en los I Premios Cuadernos de Ferretería y Bricolaje celebrados en junio de 2023 en Madrid, donde fuimos galardonados con los premios a la calidad y a la innovación en la categoría de herramientas de corte a partir de la opinión de más de un millar de profesionales de la distribución.

Todo el equipo humano de IZAR nos sentimos orgullosos del trabajo realizado y confiamos en seguir dando respuesta a las necesidades de nuestros clientes de una manera sostenible y comprometida con el medio ambiente y con la excelencia en la calidad y el servicio.

Atentamente,

Dear customers, business partners and friends,

With this IZAR PROFESIONAL 2024 catalogue, we present you the widest range of references in our history.

In this edition, we include around 10,000 items, among which we would like to highlight several new products:

Firstly, our multipurpose 1876 drill bit, with a carbide tip, exclusive IZAR sharpening, and IZAR BLUE surface treatment. It is suitable for working on refractory brick, ceramics, soft porcelain, metal, hardwood, plastics, and even on concrete with percussion.

We also emphasize our new masonry 1821 drill bit with 4 carbide blades at the tip and a 3-flat shank, ensuring maximum efficiency in the most demanding conditions with a conventional drill.

Furthermore, we offer a complete range of hexagonal shank tools for work with impact drivers, which includes tools for drilling in metal, wood, or construction, threading, countersinking, and screwing, always meeting the highest IZAR quality standards.

We have made a significant effort to develop new capabilities and expand our technical offering to find the most suitable cutting solutions for an increasingly demanding market.

This commitment to the added value of our range and service has once again been recognized at the 1st Cuadernos de Ferretería y Bricolaje Awards (Hardware & DIY magazine awards), held in June 2023 in Madrid. We were honoured with the awards for quality and innovation in the cutting tools category, based on the opinions of over a thousand distribution professionals.

The entire IZAR team is proud of the work done and confident in continuing to meet the needs of our customers in a sustainable manner and committed to the environment, and to excellence in quality and service.

Sincerely,

Elena Serrano

General Manager

IZAR Cutting Tools SAL

✉ izar@izartool.com

Chers clients, collaborateurs et amis,

Avec ce catalogue IZAR PROFESIONNEL 2024, nous vous présentons la gamme la plus étendue de références de notre histoire.

Dans cette édition, nous avons inclus près de 10 000 articles, parmi lesquels nous souhaitons mettre en avant plusieurs nouveaux produits :

Tout d'abord, notre foret multifonction 1876, avec une pointe en carbure, un affûtage exclusif IZAR et un traitement de surface IZAR BLUE. Il convient pour travailler sur de la brique réfractaire, des céramiques ou de porcelaine tendre, du métal, du bois dur, des plastiques, même du béton avec percussion.

Nous mettons également en avant notre nouveau foret béton 1821 avec 4 lames en carbure à la pointe et des plans sur la queue, garantissant une efficacité maximale dans les conditions les plus exigeantes avec une perceuse conventionnelle.

De plus, nous vous proposons une gamme d'outils queue hexagonale, destinée aux travaux avec une visseuse Impact, qui comprend des outils pour percer le métal, le bois ou la construction, le taraudage, le fraisage et le vissage, toujours avec les normes de qualité les plus élevées d'IZAR.

Nous avons déployé d'énormes efforts pour développer de nouvelles capacités et élargir notre offre technique afin de trouver les solutions de coupe les plus appropriées pour un marché de plus en plus exigeant.

Cet engagement envers la valeur ajoutée de notre gamme et de notre service a été une nouvelle fois reconnu lors des I Prix Cuadernos de Ferretería y Bricolaje (magazine de quincaillerie et bricolage), tenus en juin 2023 à Madrid. Nous avons été honorés par deux prix dans les catégories qualité et innovation pour les outils coupants, basés sur l'opinion de plus d'un millier de professionnels de la distribution.

Toute l'équipe d'IZAR est fière du travail accompli, et nous sommes convaincus de continuer à répondre aux besoins de nos clients de manière durable et engagée envers l'environnement, tout en maintenant l'excellence en termes de qualité et de service.

Cordialement,



UNA EMPRESA CON VALORES

A Company With Values
Une entreprise avec des valeurs

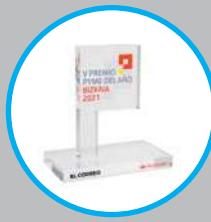

Premio PYME del año 2021 en Bizkaia
SME of the year 2021 in Bizkaia award
Prix PME de l'année 2021 en Biscaye

Valores IZAR

- La honestidad
- El enfoque al cliente
- La adaptación al cambio
- El compromiso con la calidad y con el trabajo bien hecho
- El trabajo en equipo
- El interés por la tecnología y por la innovación

IZAR Values

- Honesty
- Customer focus
- Adaptation to change
- Commitment to quality and to the job well done
- Team-work
- Interest for technology and innovation

Valeurs IZAR

- L'honnêteté
- L'orientation client
- L'adaptation au changement
- L'engagement pour la qualité et pour le travail bien fait
- Le travail en équipe
- L'intérêt pour la technologie et l'innovation



UNA EMPRESA SOCIALMENTE RESPONSABLE

A socially responsible company
Une entreprise socialement responsable



COMPROMETIDOS CON LA FABRICACIÓN Y EL EMPLEO

Committed to manufacturing and jobs
Engagés dans la fabrication et l'emploi



LA CALIDAD TOTAL NOS DISTINGUE

Total quality makes the difference
La qualité totale nous différencie

ISO 90101:2015 · ISO 14001:2015 · VPA



PRESENCIA INTERNACIONAL

International Presence
Présence Internationale



Export Sales

Tel. (+34) 94 630 02 46
Fax. (+34) 94 630 02 37
✉ export@izartool.com

Ventes France

Tel. (+34) 94 630 02 45
Fax. (+34) 94 630 02 37
✉ france@izartool.com

1 Idoia Luengas
✉ iluengas@izartool.com

2 Maite Olariaga
✉ molariaga@izartool.com

3 Mikel Goyarrola
Export Manager
✉ mgoyarrola@izartool.com

4 Itziar Urrutxua
✉ iurrutxua@izartool.com

5 Xabier Asensio
Export Area Manager
✉ xasensio@izartool.com

6 Joseba Del Pozo
Chef Produit Technique
✉ jdelpozo@izartool.com

7 Aitziber Soutiño
✉ asoutino@izartool.com

EXPORTADORES A NIVEL MUNDIAL

A Major Figure in the global market
Présent sur tous les marchés mondiaux



Top Service
Opening Hours:
8.00 - 19.00

**Service 24h
en France**

Pour commandes de articles en stock
reçues avant 14.30h



- 1 Yolanda Barrena
Administrativa Comercial
- 2 Olaia Etxebarria
Administrativa Comercial
- 3 Leire Layana
Administrativa Comercial
- 4 Leticia González
Administrativa Comercial
- 5 Isabel Hernández
Administrativa Comercial
- 6 Iker Beobide
Product Manager Industrial
✉ ibeobide@izartool.com
- 7 Iñigo Markina
Promotor Técnico
✉ imarkina@izartool.com
- 8 Oiane Gortazar
Product Manager Professional
✉ ogortazar@izartool.com
- 9 Aitor Basauri
Técnico Comercial
✉ abasauri@izartool.com
- 10 Mónica González
Directora de Ventas Iberia
✉ mgonzalez@izartool.com

LÍDERES EN MERCADO NACIONAL

Domestic market leaders
Leader sur le marché national

Ventas Mercado Nacional

Tel. 94 630 02 41
Fax. 94 630 02 36
✉ comercial@izartool.com



Servicio 24h
Horario de Atención al Cliente:
8.00 - 19.00

ÍNDICE VISUAL

Visual Index
Index visuel

METAL



Ref.		Pág.	Ref.		Pág.
1032 New!	HSSE 5% Co   	19	1007	HSS  L30 mm 	75
	MULTI-PACK			UNI-PACK	
1022 New!	HSSE 5% Co  	20	1012	HSS  DIN 338 H	76
	UNI-PACK				
1021	HSSE 5% Co  Multi INOX 	22	1025	HSS  DIN 338 N 	77
	MULTI-PACK			MULTI-PACK	
1004	HSSE 5% Co  Multi INOX 	25	1660	HSS   Max. 3 mm	78
	UNI-PACK			MULTI-PACK	
1016	HSSE 5% Co  DIN 338 N  Hard Mats. Duros	28	1052 New!	HSS + ZIRKONIO  DIN 1897 N 	80
	MULTI-PACK			MULTI-PACK	
1006	HSSE 5% Co  DIN 338 N  Hard Mats. Duros	32	1050	HSS  DIN 1897 N  Extra-Corta	81
	UNI-PACK			MULTI-PACK	
1020	HSSE 5% Co   INOX Stainless	37	1030	HSS  DIN 340 N  Larga Long	82
	MULTI-PACK			MULTI-PACK	
1005	HSSE 5% Co   INOX Stainless	40	1003	HSS  DIN 340 N  Larga Long	84
	UNI-PACK			UNI-PACK	
1027	HSSE 5% Co  L30 mm 	43	1040	HSS  DIN 1869 N  Extra Larga	86
	MULTI-PACK				
9015	Metal Duro 	44	1090	HSS  Laminada Rolled Laminé	87
				MULTI-PACK	
9289	MD/HM Carbure  	44	1009	HSS  Laminada Rolled Laminé	87
				UNI-PACK	
9100	Metal Duro 	46	1637 New!	C45 	88
1015	HSS + ZIRKONIO  DIN 338 N 	47	1110	HSS  DIN 345 N  Cónica Taper	89
	MULTI-PACK				
1065 New!	HSS + ZIRKONIO  DIN 338 N 	50	1802	 	92
	UNI-PACK				
1010	HSS + TIN  DIN 338 N  Uso General	53	1806	  Reversible	93
	MULTI-PACK				
1001	HSS + TIN  DIN 338 N  Uso General	58	1804	  Dcha. Right	93
	UNI-PACK				
1013	HSS + TIALSIN   Max. 5 mm	65	1803	  Dcha. Right	94
	MULTI-PACK				
1002	HSS   Max. 5 mm	69			
	UNI-PACK				



ÍNDICE VISUAL

Visual Index
Index visuel

METAL

Ref.		Pág.	Ref.		Pág.
9994	<p>MÁQUINA AFILADORA BROCAS Drill Bit Sharpening Machine Machine affûteuse forets</p> 	99	4076	<p>HSS-XT DOBLE WELDON</p> 	116
1602	<p>HSS  Max. 4 mm</p> 	100	4073	<p>New! Cono Holder Cône</p> 	117
1612	<p>HSS Espiral  Max. 4 mm</p> 	102	4074	<p>DOBLE WELDON</p> 	117
1607	<p>HSSE 5% Co  Max. 4 mm</p> 	103	4067	<p>TCT Serie Larga Long Length Série longue</p> 	120
1617	<p>HSSE 5% Co Espiral  Max. 4 mm</p> 	104	4060	<p>HSS-XT Serie Corta Short Length Série courte</p> 	121
1603	<p>HSS  Max. 4 mm</p> 	105	4061	<p>HSS-XT Serie Larga Long Length Série longue</p> 	122
1609	<p>HSSE 5% Co  Max. 4 mm</p> 	106	4062	<p>HSS-XT S. Extra-Larga Extra-Long S. S. extra-longue</p> 	123
1604	<p>HSSE 5% Co Serie Corta Short Length Série courte</p> 	107	1667	<p>HSS  Max. 5 mm</p> 	124
1605	<p>HSSE 8% Co S. Extra-Corta Stub Series S. extra-courte</p> 	107	1663	<p>INOX Stainless PVC Aluminio</p> 	126
1606	<p>HSS</p> 	107	1665	<p>INOX Stainless PVC Aluminio</p> 	127
1610	<p>HSS DIN 3126</p> 	108	1636	<p>HSS</p> 	128
4078	<p>TCT Serie Corta Short Length Série courte</p> 	110	2010	<p>HSS DIN 206 B ISO 236</p> 	129
4077	<p>TCT Serie Larga Long Length Série longue</p> 	111	2575	<p>HSSE 5% Co DIN 335 C</p> 	130
4070	<p>HSS-XT Serie Corta Short Length Série courte</p> 	112	2530	<p>HSS DIN 373 Allen</p> 	131
4071	<p>HSS-XT Serie Larga Long Length Série longue</p> 	113	2572	<p>HSSE 5% Co</p> 	132
4072	<p>HSS-XT S. Extra-Larga Extra-Long S. S. extra-longue</p> 	114	3030	<p>HSS DIN 352 Mano Hand Main</p>   	133
4079	<p>HSS-XT Serie Corta Short Length Série courte</p> 	115			



METAL





































Ref.				Pág.	Ref.				Pág.
3003	HSS	DIN 352	Mano Hand Main	134	3100	HSSE 5% Co	DIN 371	Máq.	153
3036	HSSE 5% Co	DIN 352 / 2181	INOX Stainless	136	3200	HSSE 5% Co	DIN 376/ 374	Máq.	154
3037	HSSE 5% Co	DIN 352 / 2181	INOX Stainless	137	3150	HSSE 5% Co	DIN 371	Máq.	155
3020	HSS	DIN 2181	Nº1 Nº3	138	3250	HSSE 5% Co	DIN 376/ 374	Máq.	156
3010	HSS	DIN 352 / 2181	Nº3	140	3119	HSSE 5% Co	ISO 529		157
3001	HSS	DIN 352	Nº3	143	3113	HSSE 5% Co	ISO 529		158
3023	HSS	DIN 352		144	3109	HSS	ISO 529		159
3040	HSS	ISO 529	Nº3	145	3157	HSS	ISO 529		161
3039	HSS	ISO 529	Tol. 6H	146	3103	HSS	ISO 529	Tol. 6H	163
3032	HSS	DIN 352	Whit-worth	149	3123	HSS	ISO 529	Tol. 6H	164
3012	HSS	DIN 352	Whit-worth	150	3500	M / MF	HSS	DIN 223	165
3026	HSS	DIN 5157	BSPP (Gas)	151	3005	HSS	DIN 223	Mano Hand Main	167
3016	HSS	DIN 5157	BSPP (Gas)	152	3536	HSSE 5% Co	DIN 22568	INOX Stainless	168
					3510	HSS	ISO 529		169
					3560	HSS	DIN 382	Tol. 6g	171
					3502	DIN 223	Whit-worth		172
					3546	HSSE 5% Co	DIN 24231	INOX Stainless	172



ÍNDICE VISUAL

Visual Index
Index visuel

METAL

Ref.				Pág.	Ref.				Pág.			
3506	BSPP (Gas)	HSS	DIN 24231		173	9230	MD HM Carbure	Tipo A Type			194	
3191	DIN 1814				174	9251	K20 + ALTIN	Tipo C Type	Radial Radial Hemisférique		195	
3912	"T" + Crique				174	9231	MD HM Carbure	Tipo C Type	Radial Radial Hemisférique		195	
3181	DIN 225				175	9252	MD/HM K20	Tipo N Type	Cono Invertido Inverted Cone Coupe en bout		196	
3184	ISO 529				175	9254	K20 + ALTIN	Tipo G Type	Ojiva Tree Ogive		196	
9016	MD HM Carbure	IZAR Std.				178	9255	MD/HM K20	Tipo M Type	Cónica Cone Conique		197
3409					179	9256	MD/HM K20	Tipo K Type	Cónica 90° 90° Cone Conique 90°		197	
ACEITES DE CORTE Y REFRIGERANTES Cutting Oils & Water Soluble Fluids Huiles de coupe et lubrifiants												
3415 New!				181	9257	MD/HM K20	Tipo E Type	Gota Oval Ovale		198		
					9237	MD HM Carbure	Tipo E Type	Gota Oval Ovale		198		
					9258	K20 + ALTIN	Tipo D Type	Esférica Ball Sphérique		199		
					9238	MD HM Carbure	Tipo D Type	Esférica Ball Sphérique		199		
3300	HSS	M / MF				187	9266	MD/HM K20	Tipo H Type	Llama Flame Flamme		200
3305	HSS	M / MF				188	9267	MD/HM K20	Tipo L Type	Redondeada Ball Nosed Conique rayon		201
3303					189	9247	MD HM Carbure	Tipo L Type	Cónica Redon. Ball Nosed Cone Conique rayon		201	
3307					189	9268	K20 + ALTIN	Tipo F Type	Ojiva Redon. Ball Nosed Tree Ogive rayon		202	
9260	K20 + ALTIN	Tipo B Type			193	9248	MD HM Carbure	Tipo F Type	Ojiva Redon. Ball Nosed Tree Ogive rayon		202	
9240	MD HM Carbure	Tipo B Type			193	9674	MD HM Carbure	IZAR Std.			206	
9250	K20 + ALTIN	Tipo A Type			194	9459	MD HM Carbure	1Z	Grabado Engraving Gravure		207	



ÍNDICE VISUAL

Visual Index
Index visuel

METAL











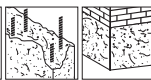
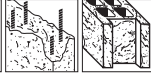







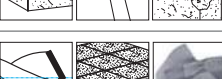











Ref.				Pág.	Ref.				Pág.		
9419	K10F + ALTiN	W	Aluminio		208	8950	DIN 263	ISO 11	Ranurado Int. Undercutting Rainurage int.		223
9411	K10F + ALTiN	W	Aluminio		208	8960	DIN 282	ISO 12	Roscado Ext. Ext. Threading Taraudage ext.		223
4412	HSS	W	Aluminio		209	8970	DIN 283	ISO 13	Roscado Int. Int. Threading Taraudage int.		224
4414	HSS	W	Aluminio		209	8990	HSSE 10% Co	DIN 4964B		225	
4223	HSSE 8% Co			211	8991	HSSE 10% Co	DIN 4964A		225		
4228	HSSE 8% Co	4% Cr		214	8992	HSSE 10% Co	DIN 4964E		226		
4229	HSSE 8% Co	4% Cr		216	8352					229	
1994	TPI 24				217	8350				230	
1999	Bimetal	TPI 18-24 32	INOX Stainless		217	8325	3-25 mm	1/8-1"		233	
1997	HSS	TPI 18-24 32	No Flexible		217	8330	3-30 mm	1/8-1" 1/8		233	
1996	CrV	TPI 24		217	8335	3-35 mm	1/8-1" 3/8		233		
8901	DIN 4971	ISO 1	Cilindrado 70° 70° Straight Cylindrage 70°		219	8341				233	
8900	DIN 4972	ISO 2	Escuadrado 45° 45° Bent Décolletage 45°		219	8326	26 mm	1"	Inox + Teflon		234
8904	DIN 4976	ISO 4	Ranurado Ext. Wide Face Square Rainurage ext.		220	8342	42 mm	1" 5/8	Inox + Teflon		235
8910	DIN 4980	ISO 6	Escuadrado 90° 90° Offset Side Décolletage 90°		220	8321				235	
8920	DIN 4981	ISO 7	Tronzado Parting Tronçonnage		221	8345				236	
8925	DIN 4973	ISO 8	Mandrinado Boring Straight Alésage		221						
8930	DIN 4974	ISO 9	Cilindrado int. Internal Sharped Cylindrage int.		222						
8940	DIN 4975	ISO 10	Cilindrado Recto Sharped Straight Cylindrage Droit		222						



























































ÍNDICE VISUAL

Visual Index
Index visuel

CONSTRUCCIÓN Construction

Ref.		Pág.
1891	SDS plus 	238
1890	SDS plus 	242
1695	SDS plus 	247
1892	SDS max 	248
1894	SDS max 	250
1697	SDS max 	251
1875	SDS max 	253
1870	SDS plus 	255
1872	SDS max 	256
1871		258
1882		259
1879		261
1883		262
1877		263
1876 New!	 Ceramic              MULTIMAT	264
1821 New!	MD/HM TCT 	267
1886	MD/HM TCT 	268
1846	MD/HM TCT 	269





































Ref.		Pág.
1880	MD/HM TCT 	272
1836	MD/HM  Ceramic 	276
1645	HSSE 8% Co 	277
1647	 Ceramic 	280
1661	 Ceramic  	282
1662	 Ceramic 	283
1860	  	286
1851	     	288
1858	     	289
1853	   Porcelain 	290
1855	   Abrasivos 	290
1861	     	288
1864	     	289
1863	  	293
1849	 	293
8309	9 mm 	294
8318 New!	18 mm  	294
8319 New!	19 mm  	295



ÍNDICE VISUAL

Visual Index
Index visuel

MADERA Wood Bois

Ref.		Pág.
1641	HSS  	298
1640	CrV  	300
1651	Heavy Duty   	304
1650	  	306
1655	CrV  	308
1644	SDS plus  	310
1643	  	311
1692 New!	SDS plus  	312
1639	HSS 	313
1685	MD HM Carbure  	314
1669	MD HM Carbure  	314
1679	MD HM Carbure  	314
1678	MD HM Carbure  	315
1674	MD HM Carbure  	315
1676	MD HM Carbure  	315
1677	MD HM Carbure  	316
1670	MD HM Carbure  	316

Ref.		Pág.
1671	MD HM Carbure  	316
1672	MD HM Carbure  	317
1673	MD HM Carbure  	317
1681	MD HM Carbure  	317
1682	MD HM Carbure  	318
1686	MD HM Carbure  	318
1615	Diente MD  	320
1620	C60  	321
1625	 	322
1689	MD HM Carbure EVA  	323
7009	MD HM Carbure   	324
7002	HSS  Pladur Escayola 	324
7003	HSS  Auto center 	325
7001	HSS  	325
1690	MD HM Carbure  	326



ÍNDICE VISUAL

Visual Index
Index visuel

New!

Atornilladores de Impacto

Impact Drivers

Visseuses impact

Colores por tipo de material
Color chart for materials
Couleurs par type de matériau

METAL

CONSTRUCTION

MADERA
WOOD
BOIS

OTROS
OTHERS
AUTRES



Testado en condiciones extremas
Tested under extreme conditions
Testé dans des conditions extrêmes

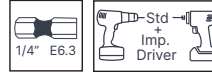

Ref.		Pág.
1616	 HSSE 5% Co Materiales duros Hard Materials Matériaux durs	329
1613	 HSS Usos general General Purpose Utilisation générale	330
1611	 HSS	331
1622	 HSSE 5% Co	333
3610	 HSSE 5% Co	334
3650	 HSSE 5% Co	335
1614	 HSS	336
1635	 HSSE 5% Co 5 Z	337
8352		338
1839	 Porcelain	340
1834	 MD/HM TCT Vidrio y porcelana blanda Glass and Soft Tiles Verre et porcelaine tendré	342
1601	 MD/HM TCT	343

Ref.		Pág.
1654	 Heavy Duty 3 Z	345
1651	 Heavy Duty	346
1650		348
1621	 CrV	349
1523	 S2	352
1524	 Standard	353
1529	 Adaptadores hexagonales Hex shank Adaptors Adaptateurs hexagonaux	354
1527		355
3407	 Extractores impacto Impact Extractors Extracteurs impact	356

















ÍNDICE VISUAL

















Visual Index
Index visuel

SIERRAS

Saw Blades

Lames scies





Ref.			Pag.
2940	 		361
2910	 		365
2930	 Especial		370
2950	 Especial		378
1950	Sable 		382
1920	Sable 		385



Ref.			Pag.
1960	Sable Especial		390
1940	Calar  Inserción "T" 		398
1910	Calar  Inserción "T" 		407
1930	Calar  Inserción "T"  Especial		412
1945	Calar  Inserción "U" 		413
1915	Calar  Inserción "U" 		415

PUNTAS ATORNILLAR

Screwdriver Bits

Embouts vissage

			Pag.
1520	Std.		418
1521	Torsión		422
1523 New!	S2 material	 	423
1524 New!	Std.		424

			Pag.
1527			425
1529	Adaptadores hexagonales Hex shank Adaptors Adaptateurs hexagonaux	 New!	426
3407	Extractores impacto Impact Extractors Extracteurs impact		427

PRESENTACIONES

Presentations

Presentations



PRESENTACIÓN IZAR EN LÍNEA
IZAR Line Presentation
Presentation IZAR ligne

Pag. 430



PRESENTACIÓN IZAR EN CASCADA
IZAR Cascade Presentation
Presentation IZAR cascade

Pag. 436



EXPOSITORES APILABLES
Stacking Exhibitors
Présentoirs apilables

Pag. 440



01.



METAL

Metal 17
Métal

BROCAS

Drill Bits 18
Forets

PORTA-BROCAS Y ACCESORIOS

Drill Chucks & Accessories 92
Mandrins et accessoires

BROCAS ESPECIALES

Special Drill Bits 100
Forets Spéciales

FRESAS HUECAS M. ELECTROMAGNÉTICAS

Annular Cutter Core Drills 110
Fraises à carotter UP électromagnétiques

CORONAS

Hole Saws 124
Trépan

ESCARIADORES

Reamers 129
Alésoirs

AVELLANADORES

Countersinks / Counterbores 130
Outils

MACHOS Y COJINETES

Taps & Dies 133
Tarauds et filières

ACEITE / LUBRICANTE CORTE

Cutting Oil / Coolant 180
Huile / Lubrifiant de coupe

REPARADORES ROSCAS

Thread Repairs 186
Filets rapportes

FRESAS ROTATIVAS, FRESAS FRONTALES

Rotary Burrs, End Mills 192
Fraises limes rotativas, Fraisés

HOJAS DE SIERRAS DE CINTA

Band Saw Blades 210
Lames de scie à ruban

HERRAMIENTAS TORNEADO

Brazed Turning Tools 218
Outils de tour

02.



CONSTRUCCIÓN

Construction 237
Construc1tion

HERRAMIENTAS SDS PLUS

SDS plus Tools 238
Outils SDS plus

HERRAMIENTAS SDS MAX

SDS max Tools 248
Outils SDS max

ADAPTADOR iCONNECT

iConnect Adaptor 252
Adaptateur iConnect

CINCELES

Chisels 254
Burins

BROCAS MANGO CILÍNDRICO

Straight Shank Drill Bits 259
Forets queue cylindrique

CORONAS

Hole Saws 277
Trépan

DISCOS DIAMANTE

Diamond Cutting Blades 287
Disques diamant



04. HEX

ATORNILLADORES DE IMPACTO Impact Drivers Visseuses impact	327
METAL Metal Métal	328
CONSTRUCCIÓN Construction Construction	329
MADERA Wood Bois	344
OTROS Others Autres	352

06.

PUNTAS ATORNILLAR Screwdriver Bits Embouts vissage	417
---	-----

03.



MADERA Wood Bois	297
BROCAS Drill Bits Forets	298
FRESAS Router Cutters Fraises	314

05.



SIERRAS Saw Blades Lames scies	357
OSCILANTES MULTI-FUNCIÓN Oscillating Multi-Tools Outils Multifonction	358
SIERRAS SABLE Sabre Saw Blades Lames scie sabre	380
SIERRAS CALAR Jig Saw Blades Lames scies sauteuses	396

07.



PRESENTACIONES Presentations Presentations	429
PRESENTACIÓN IZAR EN LÍNEA IZAR Line Presentation Presentation IZAR ligne	430
PRESENTACIÓN IZAR EN CASCADA IZAR Cascade Presentation Presentation IZAR cascade	436
EXPOSITORES APILABLES Stacking Exhibitors Présentoirs apilables	440
CONDICIONES GENERALES VENTA General Selling Conditions Conditions generales de vente	442
ÍNDICE SÍMBOLOS Symbol Index Index de symboles	444
BÚSQUEDA POR REFERENCIA (Ref. - Pag) Search by reference (Ref. - Page) Recherche par référence (Ref. - Page)	446

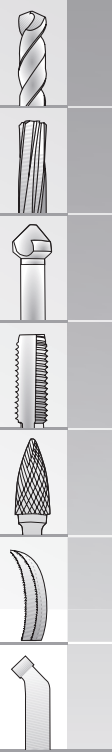

01.

METALMetal
Métal**BROCAS**Drill Bits
Forets 18**PORTABROCAS Y ACCESORIOS**Drill Chucks & Accessories
Mandrins et accessoires 92**BROCAS ESPECIALES**Special Drill Bits
Forets spéciales 100**FRESAS HUECAS M.
ELECTROMAGNÉTICAS**Annular Cutter Core Drills
Fraises à carotter UP électromagnétiques 110**CORONAS**Hole Saws
Trépan 124**ESCARIADORES**Reamers
Alésoirs 129**AVELLANADORES**Countersinks / Counterbores
Outils 130**MACHOS Y COJINETES**Taps & Dies
Tarauds et filières 133**ACEITE / LUBRICANTE CORTE**Cutting Oil / Coolant
Huile / Lubrifiant de coupe 180**REPARADORES ROSCAS**Thread Repairs
Filets rapportes 186**FRESAS ROTATIVAS,
FRESAS FRONTALES**Rotary Burrs, End Mills
Fraises limes rotatives, fraises 192**HOJAS DE SIERRAS DE CINTA**Band Saw Blades
Lames de scie à ruban 210**HERRAMIENTAS TORNEADO**Brazed Turning Tools
Outils de tour 218

METALMAX

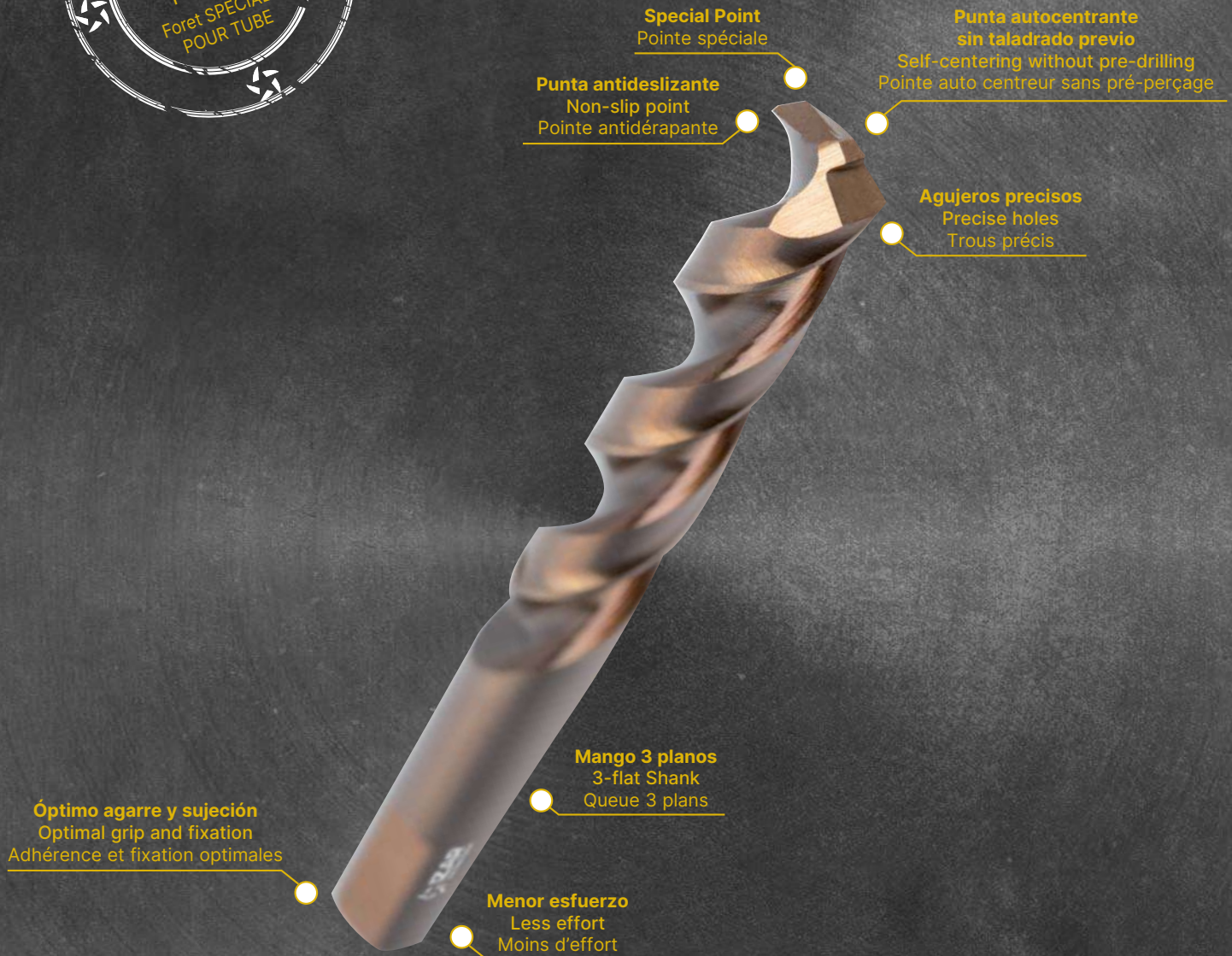

TUBO
Tube
Tube

CHAPA
Sheet
Tôle

INOX
Stainless Steel
Inox

COBRE
Copper
Cuivre

ALUMINIO
Aluminum
Aluminium



BROCAS

Drill Bits

Forets

Ref. **1032**

BROCA MANGO CILINDRICO METALMAX. SERIE CORTA

METALMAX Cobalt Drill Bit. Jobber Series

Foret cobalt METALMAX. Série courte

New!



HSSE 5%Co	DIN 338 W						Ambar Gold Finish Finition Or	Rectificado Ground Taillé meulé	Tol. D h8
------------------	-----------	--	--	--	--	--	--	--	--------------

INOX Stainless Steel Acier INOX	Cobre Copper Cuivre	Aluminio Aluminium	Tubo Tube Tube	Chapa Sheet Tôle
--	----------------------------------	------------------------------	-----------------------------	-------------------------------

D mm	L mm	I mm		N° Art.	€
1,00	34	12	10	44820	2,22
1,50	40	18	10	44822	2,12
2,00	49	24	10	15169	2,12
2,50	57	30	10	44823	1,93
3,00	61	33	10	15191	1,88
3,30	65	36	10	84181	2,05
3,50	70	39	10	15193	2,04
4,00	75	43	10	15215	2,18
4,20	75	43	10	15238	2,50
4,50	80	47	10	15243	2,51
5,00	86	52	10	15244	2,78
5,50	93	57	10	15247	3,15
6,00	93	57	10	15265	3,52
6,50	101	63	10	15270	4,23
6,80	109	69	10	84182	4,81

D mm	L mm	I mm		N° Art.	€
7,00	109	69	10	15273	4,62
7,50	109	69	10	15280	5,24
8,00	117	75	10	15282	6,53
8,50	117	75	5	15283	6,67
9,00	125	81	5	15285	7,60
9,50	125	81	5	44825	7,87
10,00	133	87	5	15291	9,88
10,20	133	87	5	84183	11,42
10,50	133	87	5	15292	11,76
11,00	142	94	5	15298	13,36
11,50	142	94	5	44828	14,51
12,00	151	101	5	15303	15,18
12,50	151	101	5	44831	17,06
13,00	151	101	5	15304	17,31



Expo - Ref. 1032



220 Pcs

∅	1	1,5	2	2,5	3	3,5	4	4,5
Pcs	10	10	10	10	10	10	10	10
∅	5	5,5	6	6,5	7			
Pcs	10	10	10	10	10			
∅	7,5	8	8,5	9				
Pcs	10	10	10	10				
∅	9,5	10	10,5	11				
Pcs	10	10	5	5				
∅	11,5	12	12,5	13				
Pcs	5	5	5	5				

N° Art. 41034: **1.236,80 €**



Ref. **1022**

BROCA COBALTO METALMAX

METALMAX Cobalt Drill Bit
Foret cobalt METALMAX

New!



HSSE 5%Co	DIN 338 W						Ambar Gold Finish Finition Or	Rectificado Ground Taillé meulé	Tol. D h8
INOX Stainless Steel Acier INOX	Cobre Copper Cuivre	Aluminio Aluminium	Tubo Tube Tube	Chapa Sheet Tôle					

D mm	L mm	I mm		N° Art.	€		D mm	L mm	I mm		N° Art.	€
1,00	34	12	2	44618	5,09	*	6,80	109	69	1	84169	5,29
1,50	40	18	2	44627	4,86	*	7,00	109	69	1	80127	5,08
2,00	49	24	2	80135	4,86	*	7,50	109	69	1	81854	5,77
2,50	57	30	2	44633	4,42	*	8,00	117	75	1	80116	7,18
3,00	61	33	2	80125	4,31	*	8,50	117	75	1	81855	7,34
3,30	65	36	2	84168	4,71	*	9,00	125	81	1	80131	8,35
3,50	70	39	2	81844	4,69	*	9,50	125	81	1	44636	8,66
4,00	75	43	2	80113	5,01	*	10,00	133	87	1	80117	10,37
4,20	75	43	1	81845	2,87		10,20	133	87	1	84170	11,99
4,50	80	47	1	81846	2,88		10,50	133	87	1	81856	12,35
5,00	86	52	1	80114	3,20		11,00	142	94	1	81857	14,02
5,50	93	57	1	81847	3,63		11,50	142	94	1	44642	15,24
6,00	93	57	1	80115	4,05		12,00	151	101	1	81858	15,94
6,50	101	63	1	81848	4,65		12,50	151	101	1	44645	17,91
							13,00	151	101	1	81859	18,17

* € = 2uds



Display 73 - Ref. 1022

New!



∅	8	8,5	9	10	10,5	11	12	13
Pcs	5	5	3	3	2	2	2	2
∅	5	5	5,5	6	6	6,5	7	7,5
Pcs	3	2	5	3	2	5	5	5
∅	1,5	2	2,5	3	3,5	4	4	4,5
Pcs	3	3	3	5	5	3	2	5

Ref. 4995 - N° Art. 13781: 508,49 €





Set **1462**

6 Pcs

Cont. Ø	Nº Art.	€
2 - 3 - 4 - 5 - 6 - 8 mm	80138	19,85



New!

Set **1459**

29 Pcs

Cont. Ø	Nº Art.	€
1 - 13 x 0,5 mm *	84159	192,19

* + Previos Roscado / Before Threading
Pré-Tarudage (3,3 - 4,2 - 6,8 - 10,2 mm)



Set **1466**

19 Pcs

Cont. Ø	Nº Art.	€
1 - 10 x 0,5 mm	80139	81,45



Set **1456**

25 Pcs

Cont. Ø	Nº Art.	€
1 - 13 x 0,5 mm	34348	171,38

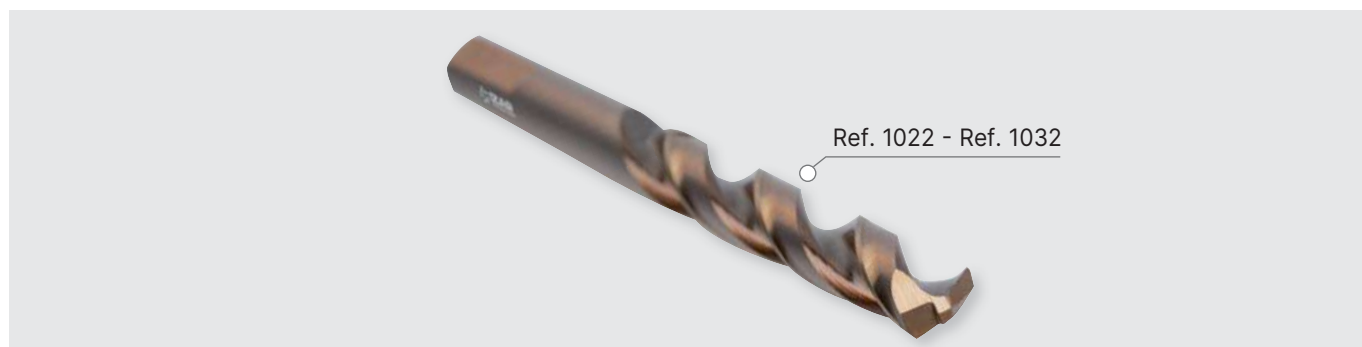

Ref. 1022 - Ref. 1032

Ref. **1021**

BROCA UNIVERSAL COBALTO MULTI INOX

Multi-STAINLESS Cobalt Universal Drill Bit
Foret universel cobalt Multi INOX



BOROA

HSSE 5% Co	DIN 338 W						 Chapa Sheets Tôle
----------------------	--------------	--	--	--	--	--	-----------------------------



Video



Aceros <850 N/mm ² Steel / Aciers	INOX Stainless Steel Acier INOX	Cobre Copper Cuivre	Aluminio Aluminium
---	--	----------------------------------	------------------------------

Ángulo de Punta 135°:

- Especial taladro mano.
- Aguzado de gran precisión.
- Menor fuerza de corte.
- Buen centrado superficies curvas.

Hélice 40°:

- Excelente evacuación de viruta.
- Taladrado más rápido y estable.
- Agujeros precisos hasta el final.

Mango de 3 Planos:

- Óptimo agarre y sujeción.
- Menor esfuerzo.
- Evita que se resbale la broca.
- Inmejorable transmisión de la energía.

135° Point Angle:

- Special portable drilling machine.
- High precision Split Point.
- Lower cutting-forces.
- Good centering on concave surfaces.

40° Helix:

- Excellent chip removal.
- Faster & stable drilling.
- Accurate holes right to the end.

3-Flat Shank:

- Optimum fixing.
- Low effort.
- No spinning in the drill-chuck.
- Ideal energy-transmission.

Angle de pointe 135°:

- Perceuses à main
- Affûtage précision
- Force de coupe inférieure
- Autocentrage surfaces courbes

Helix 40°:

- Excellente évacuation copeaux
- Perçage plus rapide et stable
- Trous précis jusqu'au bout

Queue 3 plans:

- Fixation optimale
- Effort inférieur
- Pas de glissement du foret
- Transmission d'énergie parfait

D mm	L mm	I mm		Nº Art.	€
1,00	34	12	10	25641	2,66
1,25	38	16	10	25642	3,16
1,50	40	18	10	25644	2,53
1,75	46	22	10	69953	3,16
2,00	49	24	10	25645	2,53
2,25	53	27	10	25646	2,79
2,50	57	30	10	25647	2,31
2,75	61	33	10	25648	2,79
3,00	61	33	10	25650	2,25
3,20	65	36	10	25710	2,77
3,25	65	36	10	25728	2,77
3,30	65	36	10	25730	2,77
3,50	70	39	10	25733	2,72
3,75	70	39	10	25738	3,29
4,00	75	43	10	25744	2,96
4,20	75	43	10	25751	3,29
4,25	75	43	10	25756	3,29
4,50	80	47	10	25762	3,29
4,75	80	47	10	25764	3,66
5,00	86	52	10	25769	3,52
5,20	86	52	10	25774	4,37

D mm	L mm	I mm		Nº Art.	€
5,25	86	52	10	25777	4,12
5,50	93	57	10	25780	4,45
5,75	93	57	10	25786	4,97
6,00	93	57	10	25788	4,75
6,25	101	63	10	25790	5,45
6,50	101	63	10	25793	5,54
6,75	109	69	10	25795	6,51
6,80	109	69	10	25798	6,49
7,00	109	69	10	25801	6,04
7,25	109	69	10	25803	8,29
7,50	109	69	10	25805	6,43
7,75	117	75	10	69952	9,95
8,00	117	75	10	25807	7,52
8,25	117	75	5	25809	9,57
8,50	117	75	5	25811	7,86
8,75	125	81	5	69950	12,06
9,00	125	81	5	25813	10,00
New! 9,10	125	81	5	48842	14,18
New! 9,20	125	81	5	48845	14,18
9,25	125	81	5	69949	13,34
New! 9,30	125	81	5	48848	14,18

D mm	L mm	I mm		Nº Art.	€
9,50	125	81	5	25815	10,35
9,75	133	87	5	69947	15,73
10,00	133	87	5	25817	11,43
10,20	133	87	1	32666	15,41
10,25	133	87	1	25819	20,09
10,50	133	87	1	25821	15,41
10,75	142	94	1	69946	22,15
11,00	142	94	1	25823	17,01
New! 11,10	142	94	1	48851	23,36
New! 11,20	142	94	1	48854	23,36
11,25	142	94	1	69945	24,26
New! 11,30	142	94	1	48857	23,36
11,50	142	94	1	25825	19,57
11,75	142	94	1	69944	25,12
12,00	151	101	1	25827	20,98
12,25	151	101	1	69943	26,65
12,50	151	101	1	25829	23,35
12,75	151	101	1	69941	27,83
13,00	151	101	1	25831	23,69
14,00	160	108	1	81564	25,35

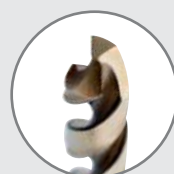



Cuartos / Quarters / Quarts

∅	1	1,5	2	2,5	3	3,25
Pcs	10	10	10	10	10	10
∅	3,5	4	4,25	4,5	5	
Pcs	10	10	10	10	10	
∅	5,5	6	6,5	7		
Pcs	10	10	10	10		
∅	7,5	8	8,5	9		
Pcs	10	10	10	10		
∅	9,5	10	11	12	13	
Pcs	5	5	2	2	2	

N° Art. 57527: **1.066,46 €**

Previos Roscado / Before Threading / Pré-Tarudage

∅	1	1,5	2	2,5	3	3,3
Pcs	10	10	10	10	10	10
∅	3,5	4	4,2	4,5	5	
Pcs	10	10	10	10	10	
∅	5,5	6	6,5	6,8		
Pcs	10	10	10	10		
∅	7	7,5	8	8,5		
Pcs	10	10	10	10		
∅	9	9,5	10	10,2	11	12
Pcs	10	5	5	2	2	2

N° Art. 57981: **1.162,18 €**

Línea 1 m - Ref. 1021



Cuartos / Quarters / Quarts

1,5 10	3	4	5	6	7	8	9	10	12	mm pcs
	2,5	3,5	4,5							
1 10	2	3,25	4,25	5,5	6,5	7,5	8,5	9,5	11	13

N° Art. 71647: **1.066,46 €**

Previos Roscado / Before Threading / Pré-Tarudage

1,5 10	3	4	5	6	7	8	9,5	10,2	12	mm pcs
	2,5	3,5	4,5				5			
1 10	2	3,3	4,2	5,5	6,5	7,5	8,5	10	11	13

N° Art. 71648: **1.162,18 €**





Expo - Ref. 1021



176 Pcs

∅	1	1,5	2	2,5	3	3,5	4	4,5		
Pcs	10	10	10	10	10	10	10	10		
∅	5		5,5		6		6,5		7	
Pcs	10		10		10		10		10	
∅	7,5			8		8,5		9		
Pcs	10			10		5		5		
∅	9,5			10		10,5		11		
Pcs	5			5		1		1		
∅	11,5			12		12,5		13		
Pcs	1			1		1		1		

N° Art. 55448: **913,21 €**





Ref. **1004**

BROCA UNIVERSAL COBALTO MULTI INOX

Multi-STAINLESS Cobalt Universal Drill Bit

Foret universel cobalt Multi INOX



BOROA

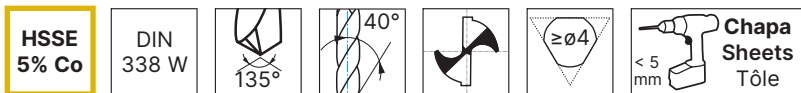

D mm	L mm	I mm		Nº Art.	€
1,00	34	12	2	55605	6,17 *
1,50	40	18	2	55606	5,87 *
2,00	49	24	2	34051	5,87 *
2,50	57	30	2	34052	5,34 *
3,00	61	33	2	34053	5,22 *
3,25	65	36	2	34054	6,18 *
3,30	65	36	2	39917	6,18 *
3,50	70	39	2	34055	6,09 *
4,00	75	43	2	34056	6,57 *
4,20	75	43	1	39918	3,69
4,25	75	43	1	34057	3,69
4,50	80	47	1	34058	3,69
5,00	86	52	1	34059	3,93
5,50	93	57	1	34060	4,96
6,00	93	57	1	34061	5,29

D mm	L mm	I mm		Nº Art.	€
6,50	101	63	1	34062	5,97
6,80	109	69	1	39919	6,98
7,00	109	69	1	34063	6,51
7,50	109	69	1	34064	6,93
8,00	117	75	1	34065	8,14
8,50	117	75	1	34066	8,49
9,00	125	81	1	34067	10,79
9,50	125	81	1	72629	11,17
10,00	133	87	1	34068	12,01
10,20	133	87	1	39920	16,19
10,50	133	87	1	74942	16,19
11,00	142	94	1	34069	17,84
11,50	142	94	1	74943	20,55
12,00	151	101	1	34070	22,03
13,00	151	101	1	34071	24,87

* € = 2 uds.

Línea 1 m - Ref. 1004



∅	1	1,5	2	2,5	3	3,25	3,5	4	4,25	4,5	5	5,5	6	6,5	7	7,5	8	9	10
Packs	3	3	5	5	10	5	5	10	5	5	10	5	10	5	5	3	5	3	3

Ref. 4995 - Nº Art. 70933: **617,61 €**

Display 62 - Ref. 1004



∅	7,5	8	8,5	9	10	11	12	13		
Packs	3	5	3	3	3	2	2	2		
∅	4,25	4,25	4,5	5	5	5,5	6	6	6,5	7
Packs	3	2	5	3	2	5	3	2	5	5
∅	2	2,5	2,5	3	3	3,25	3,5	3,5	4	4
Packs	5	3	2	3	2	5	3	2	3	2

Ref. 4995 - N° Art. 34377: 631,39 €

Display 50 - Ref. 1004 + PREVIOS ROSCADO + Before Threading + Pré-Taraudage



∅	8	8,5	9	10	10,2	11	12	13		
Packs	5	3	3	3	2	2	2	2		
∅	4,25	4,5	5	5	5,5	6	6,5	6,8	7	7,5
Packs	5	5	3	2	5	5	5	5	5	3
∅	2	2,5	3	3	3,25	3,3	3,5	4	4	4,2
Packs	5	5	3	2	5	5	5	3	2	3

Ref. 4995 - N° Art. 55633: 740,64 €

Display 52 - Mixto PRO

MULTI INOX + PARED PRO + MADERA PRO
 Multi-Stainless + Concrete Pro + Wood Pro Drill Bits
 Forets Multi INOX + Béton Pro + Bois Pro



Ref. 1886	∅	3	4	5	6	7	8	9	10	12	14
	Pcs	5	5	10	10	5	5	3	3	3	3
Ref. 1641	∅	3	3	4	4	5	5	6	6	8	10
	Pcs	3	2	3	2	3	2	3	2	5	5
Ref. 1004	∅	1	2	3	3,5	4	4,5	5	6	8	10
	Pcs	2	2	3	3	5	5	5	5	5	3

Ref. 4995 - N° Art. 68575: 505,89 €





Set **1462**

6 Pcs

Cont. Ø	Nº Art.	€
2 - 3 - 4 - 5 - 6 - 8 mm	34204	24,37



New!

Set **1459**

29 Pcs

Cont. Ø	Nº Art.	€
1 - 13 x 0,5 mm *	15114	250,25

* + Previos Roscado / Before Threading
Pré-Taroudage (3,3 - 4,2 - 6,8 - 10,2 mm)

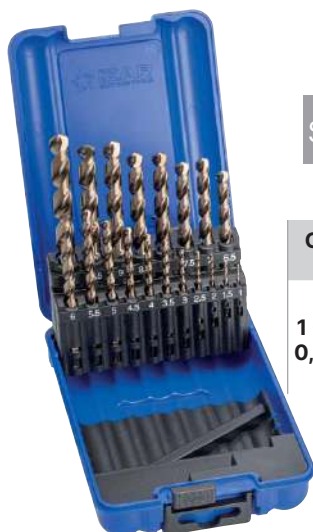

Set **1466**

19 Pcs

Cont. Ø	Nº Art.	€
1 - 10 x 0,5 mm	34201	101,50



Set **1456**

25 Pcs

Cont. Ø	Nº Art.	€
1 - 13 x 0,5 mm	34199	222,26



Box-Pallet
1021

5 Sets 1466

Cont. Set	Nº Art.	€
1 - 10 x 0,5 mm	80669	482,13



Box-Pallet
1021

5 Sets 1456

Cont. Set	Nº Art.	€
1 - 13 x 0,5 mm	80684	1.055,74



Ref. **1016**

BROCA MANGO CILÍNDRICO COBALTO

Cobalt Straight Shank Drill Bit
Foret queue cylindrique Cobalt



PROFESSIONAL

HSSE
5% Co

DIN
338 N



Materiales Duros
Hard Materials
Matériaux durs



Video



Aceros
<1300 N/mm²
Steel / Aciers

INOX Ferríticos-Martensíticos
Ferritic-Martensitic Stainless
INOX Ferritiques-Martensitiques

Titanio
Titanium
Titane

D mm	L mm	I mm		Nº Art.	€
0,50	22	6	10	37442	1,98
0,60	27	7	10	37443	2,52
0,70	28	9	10	37444	2,52
0,75	28	9	10	37445	1,80
0,80	30	10	10	37446	1,88
0,90	32	11	10	37447	1,88
1,00	34	12	10	27309	1,45
1,10	36	14	10	20107	1,79
1,20	38	16	10	28861	1,78
1,25	38	16	10	20112	1,72
1,30	38	16	10	20116	1,78
1,40	40	18	10	20125	1,78
1,50	40	18	10	27170	1,40
1,60	43	20	10	20133	1,78
1,70	43	20	10	20142	1,78
1,75	46	22	10	20146	1,72
1,80	46	22	10	20151	1,78
1,90	46	22	10	20155	1,78
2,00	49	24	10	19247	1,44
2,10	49	24	10	20161	1,70
2,20	53	27	10	20166	1,70
2,25	53	27	10	20170	1,63
2,30	53	27	10	20175	1,70
2,40	57	30	10	20184	1,70
2,50	57	30	10	19251	1,32
2,60	57	30	10	20199	1,65
2,65	57	30	10	80109	1,65
2,70	61	33	10	20203	1,65
2,75	61	33	10	19262	1,63
2,80	61	33	10	20209	1,65
2,90	61	33	10	20214	1,65
3,00	61	33	10	19256	1,30

D mm	L mm	I mm		Nº Art.	€
3,05	65	36	10	79847	1,76
3,10	65	36	10	20220	1,58
3,15	65	36	10	79848	1,76
3,20	65	36	10	20224	1,58
3,25	65	36	10	19259	1,58
3,30	65	36	10	20230	1,58
3,40	70	39	10	20235	1,65
3,50	70	39	10	19268	1,57
3,60	70	39	10	20241	1,98
3,70	70	39	10	20245	1,98
3,75	70	39	10	19269	1,84
3,80	75	43	10	20251	1,98
3,90	75	43	10	20256	1,98
4,00	75	43	10	19286	1,66
4,05	75	43	10	18949	2,07
4,10	75	43	10	20265	1,84
4,15	75	43	10	65326	2,07
4,20	75	43	10	20269	1,84
4,25	75	43	10	19271	1,84
4,30	80	47	10	20278	1,98
4,40	80	47	10	20283	1,98
4,50	80	47	10	19274	1,92
4,60	80	47	10	20289	2,19
4,70	80	47	10	20293	2,19
4,75	80	47	10	20298	2,07
4,80	86	52	10	20302	2,19
4,90	86	52	10	20311	2,19
5,00	86	52	10	19277	2,00
5,05	86	52	10	76128	2,67
5,10	86	52	10	20320	2,38
5,15	86	52	10	79849	2,67
5,20	86	52	10	20328	2,38







Ref. **1016**

BROCA MANGO CILÍNDRICO COBALTO

Cobalt Straight Shank Drill Bit
Foret queue cylindrique Cobalt

D mm	L mm	I mm		Nº Art.	€	D mm	L mm	I mm		Nº Art.	€
5,25	86	52	10	19280	2,36	9,80	133	87	10	26809	9,75
5,30	86	52	10	20340	2,38	9,90	133	87	10	27121	9,75
5,40	93	57	10	20349	2,38	10,00	133	87	10	27291	6,67
5,50	93	57	10	19290	2,52	10,10	133	87	5	27318	11,20
5,60	93	57	10	20361	3,01	10,20	133	87	5	27541	9,45
5,70	93	57	10	20370	3,01	10,25	133	87	5	27544	11,62
5,75	93	57	10	20379	2,84	10,30	133	87	5	27585	11,20
5,80	93	57	10	20388	3,01	10,40	133	87	5	27682	11,20
5,90	93	57	10	20397	3,01	10,50	133	87	5	27685	9,45
6,00	93	57	10	19301	2,71	10,60	133	87	5	27690	13,03
6,05	101	63	10	79855	3,75	10,70	142	94	5	27693	13,03
6,10	101	63	10	20415	3,34	10,75	142	94	5	27696	13,51
6,15	101	63	10	79856	3,75	10,80	142	94	5	27699	13,03
6,20	101	63	10	20424	3,34	10,90	142	94	5	27702	13,03
6,25	101	63	10	20433	3,15	11,00	142	94	5	27705	10,43
6,30	101	63	10	20442	3,34	11,10	142	94	5	27708	14,82
6,35	101	63	10	79858	3,34	11,20	142	94	5	27711	14,82
6,40	101	63	10	20451	3,34	11,25	142	94	5	27714	15,39
6,45	101	63	10	64140	3,34	11,30	142	94	5	27717	14,82
6,50	101	63	10	27290	3,22	11,40	142	94	5	27720	14,82
6,60	101	63	10	20466	4,01	11,50	142	94	5	19307	12,47
6,70	101	63	10	20475	4,01	11,60	142	94	5	27724	15,33
6,75	109	69	10	20481	3,77	11,70	142	94	5	27727	15,33
6,80	109	69	10	20488	3,77	11,75	142	94	5	27730	15,91
6,90	109	69	10	20493	4,01	11,80	142	94	5	27733	15,33
7,00	109	69	10	19305	3,52	11,90	151	101	5	27736	15,33
7,10	109	69	10	20499	5,10	12,00	151	101	5	19311	13,33
7,20	109	69	10	20503	5,10	12,10	151	101	5	27742	17,78
7,25	109	69	10	20508	4,79	12,20	151	101	5	27745	17,78
7,30	109	69	10	20512	5,10	12,25	151	101	5	19313	18,45
7,40	109	69	10	20517	5,10	12,30	151	101	5	27749	17,78
7,50	109	69	10	19292	3,77	12,40	151	101	5	27752	17,78
7,60	117	75	10	20523	6,16	12,50	151	101	5	27755	16,24
7,70	117	75	10	20527	6,16	12,60	151	101	5	27758	18,55
7,75	117	75	10	20532	5,81	12,70	151	101	5	27761	18,55
7,80	117	75	10	20536	6,16	12,75	151	101	5	19316	19,28
7,90	117	75	10	20541	6,16	12,80	151	101	5	27765	18,55
8,00	117	75	10	20208	4,41	12,90	151	101	5	27768	18,55
8,10	117	75	10	22734	5,87	13,00	151	101	5	27771	16,63
8,20	117	75	10	22737	5,87	13,25	160	108	1	27777	22,98
8,25	117	75	10	22740	5,54	13,50	160	108	1	27774	18,31
8,30	117	75	10	22743	5,87	13,75	160	108	1	27780	22,98
8,40	117	75	10	22746	5,87	14,00	160	108	1	27783	18,12
8,50	117	75	10	19298	4,57	14,25	169	114	1	27786	30,22
8,60	125	81	10	22752	7,48	14,50	169	114	1	27789	25,68
8,70	125	81	10	22755	7,48	14,75	169	114	1	27792	30,22
8,75	125	81	10	22758	7,07	15,00	169	114	1	27795	26,08
8,80	125	81	10	22761	7,48	15,25	178	120	1	27798	41,70
8,90	125	81	10	22764	7,48	15,50	178	120	1	27801	30,19
9,00	125	81	10	20358	5,84	15,75	178	120	1	27804	41,70
9,10	125	81	10	22768	8,29	16,00	178	120	1	27807	31,28
9,20	125	81	10	22771	8,29	16,50	184	125	1	27811	35,74
9,25	125	81	10	22774	7,80	17,00	184	125	1	27814	35,74
9,30	125	81	10	22777	8,29	17,50	191	130	1	27817	39,62
9,40	125	81	10	22780	8,29	18,00	191	130	1	27820	43,14
9,50	125	81	10	20545	6,07	18,50	198	135	1	27823	47,66
9,60	133	87	10	22784	9,75	19,00	198	135	1	27826	47,66
9,70	133	87	10	23567	9,75	19,50	205	140	1	27829	52,83
9,75	133	87	10	26697	9,20	20,00	205	140	1	27832	56,60





Cuartos / Quarters / Quarts

∅	1	1,5	2	2,5	3	3,25
Pcs	10	10	40	10	40	10
∅	3,5	4	4,25	4,5	5	
Pcs	10	40	10	10	40	
∅	5,5	6	6,5	7		
Pcs	10	40	10	10		
∅	7,5	8	8,5	9		
Pcs	10	30	10	10		
∅	9,5	10	11	12	13	
Pcs	10	10	5	5	5	

Nº Art. 57525: **1.171,25 €**

Previos Roscado / Before Threading / Pré-Taradage

∅	1	1,5	2	2,5	3	3,3
Pcs	10	10	40	10	40	10
∅	3,5	4	4,2	4,5	5	
Pcs	10	40	10	10	40	
∅	5,5	6	6,5	6,8		
Pcs	10	40	10	10		
∅	7	7,5	8	8,5		
Pcs	10	10	30	10		
∅	9	9,5	10	10,2	11	12
Pcs	10	10	10	5	5	5

Nº Art. 57978: **1.256,20 €**

Línea 1 m - Ref. 1016



Cuartos / Quarters / Quarts

1,5 10	3	4	5	6 40	7 10	8 30	9 10	10 10	12 5	mm pcs
	2,5 10	3,5 10	4,5 10							
1 10	2 40	3,25 10	4,25 10	5,5 10	6,5 10	7,5 10	8,5 10	9,5 10	11 5	13 5

Nº Art. 71642: **1.171,25 €**

Previos Roscado / Before Threading / Pré-Taradage

1,5 10	3	4	5	6 40	7 10	8 30	9,5 10	10,2 5	12 5	mm pcs
	2,5 10	3,5 10	4,5 10				9 10			
1 10	2 40	3,3 10	4,2 10	5,5 10	6,5 10	7,5 10	8,5 10	10 10	11 5	13 5

Nº Art. 71643: **1.256,20 €**



Expo - Ref. 1016



∅	1	1,5	2	2,5	3	3,5	4	4,5												
Pcs	10	10	10	10	10	10	10	10												
∅	5		5,5		6		6,5		7											
Pcs	10		10		10		10		10											
∅	7,5			8			8,5			9										
Pcs	10			10			10			10										
∅	9,5				10				10,5				11							
Pcs	10				10				5				5							
∅	11,5					12					12,5					13				
Pcs	5					5					5					5				

N° Art. 55449: **966,35 €**



Ref. **1006**

BROCA MANGO CILÍNDRICO COBALTO

Cobalt Straight Shank Drill Bit
Foret queue cylindrique Cobalt



PROFESSIONAL

HSSE
5% Co

DIN
338 N



Materiales Duros
Hard Materials
Matériaux durs

Aceros
<1300 N/mm²
Steel / Aciers

INOX Ferríticos-Martensíticos
Ferritic-Martensitic Stainless
INOX Ferritiques-Martensitiques

Titanio
Titanium
Titane

D mm	L mm	I mm		Nº Art.	€
1,00	34	12	2	30163	3,41 *
1,50	40	18	2	30164	3,25 *
2,00	49	24	2	18480	3,36 *
2,50	57	30	2	30165	3,06 *
2,80	61	33	2	79615	3,74 *
3,00	61	33	2	18481	2,93 *
3,25	65	36	2	30166	3,53 *
3,30	65	36	2	34035	3,53 *
3,50	70	39	2	30167	3,50 *
3,80	75	43	2	79616	4,48 *
4,00	75	43	2	18483	3,77 *
4,20	75	43	1	34036	2,08
4,25	75	43	1	30168	2,08
4,50	80	47	1	30169	2,15
4,80	86	52	1	79617	2,50
5,00	86	52	1	18484	2,25
5,50	93	57	1	30170	2,86
6,00	93	57	1	18486	2,94
6,50	101	63	1	30171	3,50
6,80	109	69	1	34037	4,13
7,00	109	69	1	18487	3,83
7,50	109	69	1	30172	4,12
8,00	117	75	1	18489	4,81
8,50	117	75	1	30162	5,04
9,00	125	81	1	18490	6,39
9,50	125	81	1	66997	6,43
10,00	133	87	1	18492	7,08
10,20	133	87	1	34038	10,00
10,50	133	87	1	66998	10,00
11,00	142	94	1	30161	11,05
11,50	142	94	1	66999	13,23
12,00	151	101	1	18493	14,15
12,50	151	101	1	67000	17,23
13,00	151	101	1	30160	17,64
14,00	160	108	1	79618	19,22
15,00	169	114	1	79619	27,68



* € = 2 uds.

Línea 1 m - Ref. 1006



∅	1	1,5	2	2,5	3	3,25	3,5	4	4,25	4,5	5	5,5	6	6,5	7	7,5	8	9	10
Packs	5	5	10	5	10	5	10	10	10	10	10	10	10	10	10	10	10	10	10

Ref. 4995 - N° Art. 70936: 621,95 €



Display 13 - Ref. 1006



∅	7,5	8	8,5	9	10	11	12	13		
Packs	5	5	5	5	5	3	3	3		
∅	4	4,25	4,5	5	5	5,5	6	6	6,5	7
Packs	5	10	5	5	5	5	5	5	5	5
∅	1	1,5	2	2,5	3	3	3,25	3,5	3,5	4
Packs	5	5	10	5	5	5	10	5	5	5

Ref. 4995 - N° Art. 22181: **619,62 €**

Display 48 - Ref. 1006 + PREVIOS ROSCADO + Before Threading + Pré-Taraudage



∅	8	8,5	9	10	10,2	11	12	13		
Packs	5	5	5	5	3	3	3	3		
∅	4,25	4,5	5	5	5,5	6	6,5	6,8	7	7,5
Packs	5	5	5	5	5	10	5	5	5	5
∅	1	1,5	2	2,5	3	3,25	3,3	3,5	4	4,2
Packs	5	5	5	5	10	5	5	10	10	5

Ref. 4995 - N° Art. 55621: **653,47 €**

Display 24 - Refs. 1016 - 1010



SETS BROCAS MANGO CILINDRICO HSS + HSSE

HSS + HSSE Straight Shank Drill Bit Sets
Jeux Forets Queue Cylindrique HSS + HSSE

HSSE		Set 1462 - Ref. 1016 Metal Pro 5 Pcs.	Set 1466 - Ref. 1016 Metal Pro 19 Pcs.	Set 1456 - Ref. 1016 Metal Pro 25 Pcs.
	Pcs	5	1	1
HSS		Set 1462 - Ref. 1010 Metal 5 Pcs.	Set 1466 - Ref. 1010 Metal 19 Pcs.	Set 1456 - Ref. 1010 Metal 25 Pcs.
	Pcs	5	2	2

Ref. 4995 - N° Art. 22320: **530,93 €**



Set **1462**

6 Pcs

Cont. Ø	Nº Art.	€
2 - 3 - 4 - 5 - 6 - 8 mm	30231	14,36



New!

Set **1459**

29 Pcs

Cont. Ø	Nº Art.	€
1 - 13 x 0,5 mm *	15073	155,69

* + Previos Roscado / Before Threading
Pré-Taraudage (3,3 - 4,2 - 6,8 - 10,2 mm)



Set **1466**

19 Pcs

Cont. Ø	Nº Art.	€
1 - 10 x 0,5 mm	25274	59,72

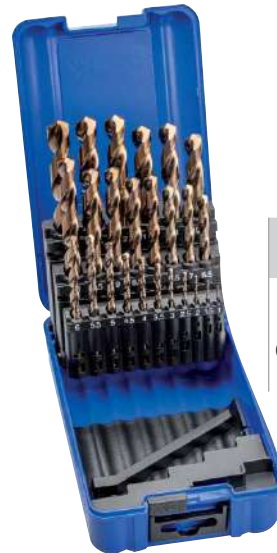

Set **1456**

25 Pcs

Cont. Ø	Nº Art.	€
1 - 13 x 0,5 mm	18370	139,02



Box-Pallet
1016

5 Sets 1466

Cont. Set	Nº Art.	€
1 - 10 x 0,5 mm	80664	283,67



Box-Pallet
1016

5 Sets 1456

Cont. Set	Nº Art.	€
1 - 13 x 0,5 mm	80680	660,35





Set 1407



37 Pcs

Cont. Ø	Nº Art.	€
1 - 10 × 0,25 mm	18367	155,27

Set 1409



49 Pcs

Cont. Ø	Nº Art.	€
1 - 13 × 0,25 mm	18369	330,36

Set 1405



50 Pcs

Cont. Ø	Nº Art.	€
1 - 5,9 × 0,1 mm	10788	106,48

Set 1408



41 Pcs

Cont. Ø	Nº Art.	€
6 - 10 × 0,1 mm	18366	258,76

Set 1406



91 Pcs

Cont. Ø	Nº Art.	€
1-10 × 0,10 mm	56686	354,78

New!

Set 1404

99 Pcs



Cont. Ø	Nº Art.	€
1 - 10 × 0,10 mm *	48821	449,71

* +Previos Roscado / Before Threading
Pré-Taroudage (< 13 mm)

Set 1410

NOVABOX

Mida y ubique las brocas en un solo movimiento Gauge and place the drills in one single movement

Measurer et classer les forets en une seule course

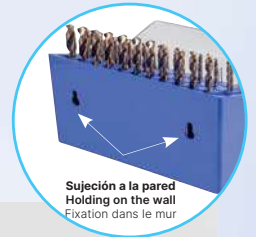

Sujeción a la pared
Holding on the wall
Fixation dans le mur

- Almacene y trabaje con este juego de 55 brocas para metal
- Manejo fácil para colocar las brocas en los huecos correspondientes
- Posibilidad de colgar en la pared gracias al colgador trasero
- Storage and management in a 55 metalworking drill set
- Easy use to put drills in suitable socket
- Possibility to hang on the wall
- Stockez et travaillez avec ce jeu de 55 forets
- Utilisation facile pour ranger les forets dans le trou correspondant
- Possibilité d'accrocher au mur grâce au crochet arrière



Agujeros para:

- Brocas desde 1 a 13 mm x 0,5 mm
- Incluye los siguientes diámetros previos al roscado:
ø2,5 / 3,3 / 4,2 / 5,0 / 6,8 / 8,5 / 10,2 / 12,0 mm
para las métricas de roscado
M3 / M4 / M5 / M6 / M8 / M10 / M12 / M14

Holes for:

- Drill diameters from 1 to 13 mm x 0,5 mm
- Includes core hole sizes:
ø2,5 / 3,3 / 4,2 / 5,0 / 6,8 / 8,5 / 10,2 / 12,0 mm for
threading dimensions
M3 / M4 / M5 / M6 / M8 / M10 / M12 / M14

Trous pour:

- Forets de 1 à 13 mm x 0,5 mm
- Inclut les diamètres suivantes pré-taraudage:
ø2,5 / 3,3 / 4,2 / 5,0 / 6,8 / 8,5 / 10,2 / 12,0 mm
pour les métriques de taraudage
M3 / M4 / M5 / M6 / M8 / M10 / M12 / M14

New!



55 Pcs

Cont. Ø	Nº Art.	€
1 - 13 x 0,5 mm		
Ø1,0 - 4,0 mm: 3 pcs	19537	235,30
Ø4,2 - 8,0 mm: 2 pcs		
Ø8,50 - 13,0 mm: 1 pcs		

Sets 1470

170 Pcs



Cont. Ø	Nº Art.	€
1-10 x 0,5 mm		
ø 1-8: 10 pcs/ø	10676	470,39
ø 8,5-10: 5 pcs/ø		

220 Pcs



Cont. Ø	Nº Art.	€
1-13 x 0,5 + 3,3 + 4,2 mm		
ø 1-8: 10 pcs/ø	25391	930,73
ø 8,5-13: 5 pcs/ø		



Ref. **1020**

BROCA MANGO CILÍNDRICO COBALTO INOX

STAINLESS Cobalt Straight Shank Drill Bit
Foret queue cylindrique Cobalt INOX



SPEED MAX

HSSE 5% Co	DIN 338 W			DIN 1412 C ≥ 2 mm				Chapa Sheets Tôle < 5 mm
----------------------	--------------	--	--	-------------------------	--	--	--	-----------------------------------



INOX Stainless Steel Acier INOX	Aluminio Aluminium
--	------------------------------

	D	L	I		Nº	€		D	L	I		Nº	€		D	L	I		Nº	€
	mm	mm	mm		Art.			mm	mm	mm		Art.			mm	mm	mm		Art.	
	1,00	34	12	10	14115	2,14		5,25	86	52	10	16297	3,30		9,40	125	81	5	14026	11,20
New!	1,10	36	14	10	13950	2,60		5,30	86	52	10	13984	3,35		9,50	125	81	5	16316	8,30
New!	1,20	36	16	10	13951	2,59		5,40	93	57	10	13986	3,35		9,60	133	87	5	14027	13,34
	1,25	38	16	10	14116	2,53		5,50	93	57	10	16298	3,57		9,70	133	87	5	14028	13,34
New!	1,30	38	16	10	13953	2,59		5,60	93	57	10	13987	4,40		9,75	133	87	5	69935	12,58
New!	1,40	40	18	10	13954	2,59		5,70	93	57	10	25134	4,40		9,80	133	87	5	14029	13,34
	1,50	40	18	10	14117	2,03		5,75	93	57	10	16299	3,98		9,90	133	87	5	14060	13,34
New!	1,60	43	20	10	13955	2,59		5,80	93	57	10	13989	4,40		10,00	133	87	5	16318	9,16
New!	1,70	43	20	10	13956	2,59		5,90	93	57	10	13991	4,40		10,10	133	87	5	14064	15,22
New!	1,80	46	22	10	13958	2,52		6,00	93	57	10	16302	3,79		10,20	133	87	5	14248	12,34
New!	1,90	46	22	10	13959	2,52		6,10	101	63	10	13993	4,65		10,25	133	87	5	21634	16,07
	2,00	49	24	10	21615	2,03		6,20	101	63	10	13994	4,65		10,30	133	87	5	74568	15,22
	2,10	49	24	10	13961	2,36		6,25	101	63	10	21627	4,36		10,40	133	87	5	74567	15,22
	2,20	53	27	10	13962	2,36		6,30	101	63	10	14002	4,65		10,50	133	87	5	16320	12,34
	2,25	53	27	10	21616	2,24		6,40	101	63	10	14003	4,65		10,60	133	87	5	74566	17,95
	2,30	53	27	10	13963	2,36		6,50	101	63	10	16304	4,42		10,70	142	94	5	74565	17,95
	2,40	57	30	10	13965	2,36		6,60	101	63	10	14004	5,52		10,75	142	94	5	69934	17,71
	2,50	57	30	10	21618	1,84		6,70	101	63	10	14005	5,52		10,80	142	94	5	14249	17,95
	2,60	57	30	10	13966	2,36		6,75	109	69	10	21628	5,20		10,90	142	94	5	74564	17,95
	2,70	61	33	10	13968	2,36		6,80	109	69	10	16306	5,20		11,00	142	94	5	16321	13,63
	2,75	61	33	10	21625	2,24		6,90	109	69	10	14006	5,52		11,10	142	94	5	30587	19,86
	2,80	61	33	10	12964	2,42		7,00	109	69	10	16307	4,83		11,20	142	94	5	14250	19,86
	2,90	61	33	10	13969	2,42		7,10	109	69	10	14007	6,95		11,25	142	94	5	69932	19,42
	3,00	61	33	10	16283	1,81		7,20	109	69	10	14008	6,95		11,30	142	94	5	74563	19,86
	3,10	65	36	10	17970	2,22		7,25	109	69	10	21631	6,62		11,40	142	94	5	74562	19,95
	3,20	65	36	10	16284	2,22		7,30	109	69	10	14009	6,95		11,50	142	94	5	16322	15,68
	3,25	65	36	10	16285	2,22		7,40	109	69	10	14010	6,95		11,60	142	94	5	74561	20,55
	3,30	65	36	10	16286	2,22		7,50	109	69	10	16309	5,16		11,70	142	94	5	74560	20,55
	3,40	70	39	10	13971	2,42		7,60	117	75	10	14011	8,42		11,75	142	94	5	69931	20,09
	3,50	70	39	10	16287	2,20		7,70	117	75	10	14012	8,42		11,80	142	94	5	14252	20,55
	3,60	70	39	10	13972	2,90		7,75	117	75	10	69940	7,95		11,90	151	101	5	74559	20,55
	3,70	70	39	10	14120	2,90		7,80	117	75	10	14013	8,42		12,00	151	101	5	16323	16,82
	3,75	70	39	10	16288	2,63		7,90	117	75	10	14014	8,42		12,10	151	101	5	74558	21,58
	3,80	75	43	10	12507	2,90		8,00	117	75	10	16311	6,03		12,20	151	101	5	14276	21,58
	3,90	75	43	10	13974	2,90		8,10	117	75	5	14015	8,02		12,25	151	101	5	69929	21,31
	4,00	75	43	10	16289	2,36		8,20	117	75	5	14016	8,02		12,30	151	101	5	74557	21,58
	4,10	75	43	10	16290	2,63		8,25	117	75	5	21633	7,65		12,40	151	101	5	74556	21,58
	4,20	75	43	10	16291	2,63		8,30	117	75	5	14017	8,02		12,50	151	101	5	16324	18,72
	4,25	75	43	10	16292	2,63		8,40	117	75	5	14018	8,02		12,60	151	101	5	74554	22,52
	4,30	80	47	10	14122	2,90		8,50	117	75	5	16313	6,30		12,70	151	101	5	74553	22,52
	4,40	80	47	10	13975	2,90		8,60	125	81	5	14019	10,31		12,75	151	101	5	69928	22,27
	4,50	80	47	10	16293	2,63		8,70	125	81	5	14020	10,31		12,80	151	101	5	14288	22,52
	4,60	80	47	10	13979	3,08		8,75	125	81	5	69938	9,65		12,90	151	101	5	74552	22,52
	4,70	80	47	10	13981	3,08		8,80	125	81	5	14021	10,31		13,00	151	101	5	16325	18,99
	4,75	80	47	10	16294	2,93		8,90	125	81	5	14022	10,31	New!	13,50	160	108	1	25995	21,06
	4,80	86	52	10	14123	3,23		9,00	125	81	5	16314	8,00	New!	14,00	160	114	1	25996	20,84
	4,90	86	52	10	13983	3,23		9,10	125	81	5	14023	11,20	New!	14,50	169	114	1	25999	29,53
	5,00	86	52	10	16295	2,83		9,20	125	81	5	14024	11,20	New!	15,00	169	114	1	26000	29,99
	5,10	86	52	10	16296	3,34		9,25	125	81	5	69937	10,68	New!	15,25	178	120	1	26001	47,96
	5,20	86	52	10	28626	3,49		9,30	125	81	5	14025	11,20	New!	15,50	178	120	1	26004	34,72
														New!	16,00	178	120	1	26005	35,98



Expo - Ref. 1020



Cuartos / Quarters / Quarts

∅	1	1,5	2	2,5	3	3,25
Pcs	10	10	20	10	20	10
∅	3,5	4	4,25	4,5	5	
Pcs	20	20	10	10	20	
∅	5,5	6		6,5	7	
Pcs	10	20		10	10	
∅	7,5	8		8,5	9	
Pcs	10	10		5	10	
∅	9,5	10	11	12	13	
Pcs	5	5	5	5	5	

Nº Art. 57526: **1.121,40 €**

Previos Roscado / Before Threading / Pré-Taraudage

∅	1	1,5	2	2,5	3	3,3
Pcs	10	10	20	10	20	10
∅	3,5	4	4,2	4,5	5	
Pcs	20	20	10	10	20	
∅	5,5	6		6,5	6,8	
Pcs	10	20		10	10	
∅	7	7,5	8	8,5		
Pcs	10	10	10	5		
∅	9	9,5	10	10,2	11	12
Pcs	10	5	5	5	5	5

Nº Art. 57979: **1.235,10 €**

Línea 1 m - Ref. 1020

Cuartos / Quarters / Quarts

1,5 10	3 20	4 20	5 20	6 20	7 10	8 10	9 10	10 5	12 5	mm pcs
	2,5 10	3,5 20	4,5 10							
1 10	2 20	3,25 10	4,25 10	5,5 10	6,5 10	7,5 10	8,5 5	9,5 5	11 5	13 5

Nº Art. 71644: **1.121,40 €**

Previos Roscado / Before Threading / Pré-Taraudage

1,5 10	3 20	4 20	5 20	6 20	7 10	8 10	9,5 5	10,2 5	12 5	mm pcs
	2,5 10	3,5 20	4,5 10		6,8 10		9 10			
1 10	2 20	3,3 10	4,2 10	5,5 10	6,5 10	7,5 10	8,5 5	10 5	11 5	13 5

Nº Art. 71646: **1.235,10 €**



Expo - Ref. 1020



200 Pcs

∅	1	1,5	2	2,5	3	3,5	4	4,5
Pcs	10	10	10	10	10	10	10	10
∅	5	5,5	6	6,5	7			
Pcs	10	10	10	10	10			
∅	7,5	8	8,5	9				
Pcs	10	10	5	5				
∅	9,5	10	10,5	11				
Pcs	5	5	5	5				
∅	11,5	12	12,5	13				
Pcs	5	5	5	5				

N° Art. 55446: **1.116,40 €**



Ref. **1005**

BROCA MANGO CILÍNDRICO COBALTO INOX

STAINLESS Cobalt Straight Shank Drill Bit
Foret queue cylindrique Cobalt INOX



SPEED MAX

HSSE 5% Co	DIN 338 W				 < 5 mm	Chapa Sheets Tôle
----------------------	--------------	--	--	--	------------	--------------------------------

INOX
Stainless Steel
Acier INOX

Aluminio
Aluminium

D mm	L mm	I mm		Nº Art.	€
1,00	34	12	2	70000	4,81 *
1,50	38	16	2	70001	4,59 *
2,00	49	24	2	24757	4,73 *
2,50	57	30	2	24758	4,31 *
3,00	61	33	2	24759	4,19 *
3,25	65	36	2	24760	4,96 *
3,30	65	36	2	55632	4,96 *
3,50	70	39	2	24761	4,88 *
4,00	75	43	2	24762	5,26 *
4,20	75	43	1	55635	2,94
4,25	75	43	1	24763	2,94
4,50	80	47	1	24764	2,94
5,00	86	52	1	24765	3,14
5,50	93	57	1	24766	3,98
6,00	93	57	1	24767	4,24
6,50	101	63	1	24768	4,79
6,80	109	69	1	55636	5,61
7,00	109	69	1	24769	5,22
7,50	109	69	1	24770	5,56
8,00	117	75	1	24771	6,51
8,50	117	75	1	24772	6,79
9,00	125	81	1	24773	8,68
10,00	133	87	1	24774	9,61
10,20	133	87	1	55638	12,93
11,00	142	94	1	24775	14,30
12,00	151	101	1	24776	17,65
13,00	151	101	1	24777	19,95



* € = 2 uds.



Línea 1 m - Ref. 1005



∅	1	1,5	2	2,5	3	3,25	3,5	4	4,25	4,5	5	5,5	6	6,5	7	7,5	8	9	10
Packs	3	3	5	5	10	5	5	10	5	5	10	5	10	5	5	3	5	3	3

Ref. 4995 - Nº Art. 70940: 494,35 €

Display 16 - Ref. 1005



∅	7,5	8	8,5	9	10	11	12	13		
Packs	5	5	5	5	3	2	2	2		
∅	4,25	4,25	4,5	5	5	5,5	6	6	6,5	7
Packs	3	2	5	5	5	5	3	2	5	5
∅	2	2,5	2,5	3	3	3,25	3,5	3,5	4	4
Packs	5	3	2	5	5	5	3	2	5	5

Ref. 4995 - Nº Art. 22497: 611,18 €

Display 49 - Ref. 1005 + PREVIOS ROSCADO + Before Threading + Pré-Taroudage



∅	8	8,5	9	10	10,2	11	12	13		
Packs	5	3	3	3	3	2	2	2		
∅	4,25	4,5	5	5	5,5	6	6,5	6,8	7	7,5
Packs	5	5	5	5	5	10	5	5	5	3
∅	2	2,5	3	3	3,25	3,3	3,5	4	4	4,2
Packs	5	5	5	5	5	5	5	5	5	5

Ref. 4995 - Nº Art. 55629: 696,66 €



Set 1462

6 Pcs

Cont. Ø	Nº Art.	€
2 - 3 - 4 - 5 - 6 - 8 mm	25367	19,69



New!

Set 1459

29 Pcs

Cont. Ø	Nº Art.	€
1 - 13 x 0,5 mm *	15113	201,14

* + Previos Roscado / Before Threading
Pré-Taradage (3,3 - 4,2 - 6,8 - 10,2 mm)

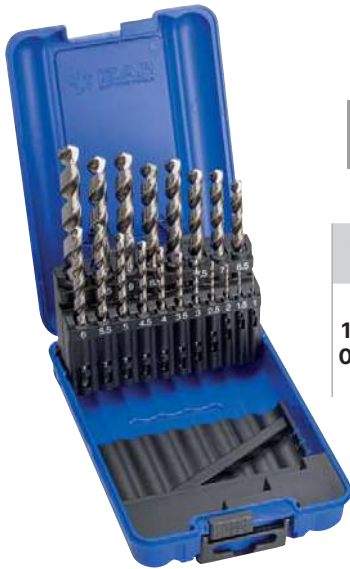

Set 1466

19 Pcs

Cont. Ø	Nº Art.	€
1 - 10 x 0,5 mm	24636	81,79



Set 1456

25 Pcs

Cont. Ø	Nº Art.	€
1 - 13 x 0,5 mm	24638	178,72



Box-Pallet
1020

5 Sets 1466

Cont. Set	Nº Art.	€
1 - 10 x 0,5 mm	80667	388,50



Box-Pallet
1020

5 Sets 1456

Cont. Set	Nº Art.	€
1 - 13 x 0,5 mm	80682	848,92



Ref. **1027**

BROCA MANGO REBAJADO COBALTO

Cobalt Reduced Shank Drill Bit
Foret queue reduite Cobalt



Aceros
<1300 N/mm²
Steel / Aciers

INOX Ferríticos-Martensíticos
Ferritic-Martensitic Stainless
INOX Ferritiques-Martensitiques

Titanio
Titanium
Titane

D mm	d mm	L mm	l mm		Nº Art.	€
10,50	10,00	133	87	1	54954	12,26
11,00	10,00	142	94	1	54955	13,54
11,50	10,00	142	94	1	54956	16,22
12,00	10,00	151	101	1	22346	17,35
12,50	10,00	151	101	1	54957	21,10
13,00	10,00	151	101	1	22347	22,26
13,50	12,70	160	108	1	49200	23,82
14,00	12,70	160	108	1	22344	24,26
14,50	12,70	169	114	1	49201	33,40
15,00	12,70	169	114	1	22348	34,90
15,50	12,70	178	120	1	49223	39,24
16,00	12,70	178	120	1	22349	40,25
16,50	12,70	184	125	1	54979	46,44
17,00	12,70	184	125	1	22350	46,00
17,50	12,70	191	130	1	54958	51,51
18,00	12,70	191	130	1	22351	55,55
18,50	12,70	198	135	1	54959	61,98
19,00	12,70	198	135	1	22353	61,34
19,50	12,70	205	140	1	54960	68,71
20,00	12,70	205	140	1	22354	72,83
20,50	12,70	205	145	1	66946	76,68
21,00	12,70	205	145	1	66941	76,68
21,50	12,70	210	150	1	66945	84,59
22,00	12,70	210	150	1	66940	84,59
22,50	12,70	210	150	1	66944	92,55
23,00	12,70	210	150	1	66939	92,55
23,50	12,70	220	160	1	66943	102,12
24,00	12,70	220	160	1	66938	102,12
24,50	12,70	220	160	1	66942	111,35
25,00	12,70	220	160	1	66937	111,35



Línea 1 m - Ref. 1027



∅	12	12,5	13	13,5	14	15	15,5	16	16,5	17	17,5	18	18,5	19	19,5	20
Pcs	1	1	1	1	1	1	1	1	1	1	1	1	1	1	1	1

Ref. 4995 - Nº Art. 72076: **687,54 €**



Ref. **9015**

BROCA ROMPE BOMBILLOS CERRADURAS

Cylinder Lock Breaker Drill Bit

Foret destructeur de trous de serrure



MD
HM
Carbure



D mm	d mm	L mm	I mm	Nº Art.	€
6	6	60	34	70727	59,21



- Metal Duro monoblock de última generación
- Punta auto centrante
- Afilado especial IZAR
- Precisión y buen acabado
- Apto para bombillos de latón y acero o bombillos de seguridad.
- Last generation monoblock Solid Carbide
- Autocentering point
- IZAR special Sharpening
- Good Precision and Finishing
- Suitable for brass, steel or security cylinder locks
- Carbure monoblock dernière génération
- Pointe autocentrante
- Affûtage spéciale IZAR
- Précision et bonne qualité de finition
- Conçu pour serrure en laiton et acier ou serrure de sécurité

Ref. **9289**

FRESA MICROGRANO CERRADURAS

Lock Micrograin End Mill

Fraise micrograin serrures

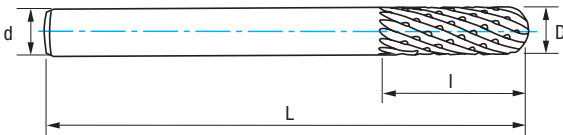

MD
HM
Carbure



D mm	d mm	L mm	I mm	Nº Art.	€	Nº Art. ALTIN	€
3	6	60	15	53893	18,81	14935	22,76
4	6	60	15	53894	19,39	14941	23,35
6	6	60	18	53895	20,41	14944	26,13



SET CERRAJEROS
Locksmith Set
Jeu serruriers



4 Pcs

Cont.	Nº Art.	€
Ref. 9015: ø 6 mm	53879	117,82
Ref. 9289: ø 3-4-6 mm		



Modern Production Facilities

izartool.com/en

Ref. **9100**

BROCA MANGO CILÍNDRICO PUNTA METAL DURO

Carbide Tipped Straight Shank Drill Bit
Foret queue cylindrique pointe carbure



**MD
HM
Carbure**

DIN
338 N



**Aceros
<1000 N/mm²
Steel / Aciers**

**Aceros
<1300 N/mm²
Steel / Aciers**

**Fundición
Cast Iron
Fonte**

**Titanio
Titanium
Titane**

**Cobre
Copper
Cuivre**

**Duroplásticos
Hard Plastics
Plastiques durs**



D mm	L mm	I mm		Nº Art.	€
2,00	49	24	1	71429	16,44
2,50	57	30	1	71444	16,44
2,70	57	30	1	46916	16,44
3,00	61	33	1	71459	16,44
3,10	61	33	1	46917	16,93
3,20	65	36	1	23058	16,93
3,30	65	36	1	26716	16,93
3,40	70	39	1	29479	16,93
3,50	70	39	1	71474	16,93
3,60	70	39	1	52285	16,93
4,00	75	43	1	71489	16,93
4,10	75	43	1	46918	16,93
4,20	75	43	1	22016	16,93
4,50	80	47	1	71504	17,37
4,60	80	47	1	26963	17,37
4,70	80	47	1	17101	17,37
4,80	86	52	1	26964	17,37
5,00	86	52	1	71516	17,37
5,10	86	52	1	23059	18,32
5,20	86	52	1	67682	18,32
5,50	93	57	1	71531	18,32
5,60	93	57	1	32603	19,22
5,70	93	57	1	23889	19,22
5,80	93	57	1	54039	19,22
6,00	93	57	1	71543	19,22
6,10	101	63	1	23891	22,90
6,20	101	63	1	32691	22,90

D mm	L mm	I mm		Nº Art.	€
6,30	101	63	1	32692	22,90
6,50	101	63	1	71558	22,90
6,60	101	63	1	30614	22,91
6,80	109	69	1	23893	22,91
7,00	109	69	1	71573	22,91
7,50	109	69	1	71585	23,81
7,80	117	75	1	23914	23,81
8,00	117	75	1	71600	23,81
8,50	117	75	1	71615	25,98
8,60	125	81	1	27007	40,41
9,00	125	81	1	71630	25,98
9,50	125	81	1	71645	28,38
10,00	133	87	1	71660	28,38
10,20	133	87	1	27008	36,57
10,50	133	87	1	71663	36,57
11,00	142	94	1	71666	36,57
11,50	142	94	1	71672	42,05
12,00	151	101	1	71675	42,05
12,50	151	101	1	71681	50,33
13,00	151	101	1	71684	50,33
14,00	160	108	1	71690	58,56
15,00	169	114	1	71696	66,77
16,00	178	120	1	71702	76,87
17,00	184	125	1	71705	84,17
18,00	191	130	1	71711	90,59
19,00	198	135	1	71717	112,54
20,00	205	140	1	71723	128,09



NUEVA PUNTA

Máximo rendimiento

NEW TIP

Maximum performance

NOUVELLE POINTE

Rendement maximal

Ref. **1015**

BROCA MANGO CILÍNDRICO ZIRKONIO

Zirkonio Straight Shank Drill Bit
Foret queue cylindrique Zirkonio



ZIRKONIO



HSS

Zirkonio

DIN 338 N



Tol. D h8



Video

Aceros
<850 N/mm²
Steel / Aciers

Fundición
Cast Iron
Fonte

Aluminio
Aluminium

Ángulo punta 118°

- Autocentradora
- Ideal taladro portátil
- Geometría especial diseñada para reducir el esfuerzo de corte

118° Point Angle

- Autocentering
- Ideal Portable Drilling Machine
- Special Geometry designed for reducing cutting effort

Angle Pointe 118°

- Autocentreur
- Perceuse à main
- Géométrie pour réduire l'effort de coupe

Nuevo recubrimiento Zirkonio de última generación por PVD

- Basado en ZRN
- Bajo coeficiente de fricción
- Muy resistente a la corrosión
- Adecuado para materiales no férricos
- Evita la adherencia de material en el filo de corte

Latest generation Zirkonio coating by PVD

- Based on ZRN
- Low Friction Coefficient
- High Corrosion Resistant
- Appropriate for Non-Ferrous Materials
- Built-Up Edge avoided

Nouveau revêtement Zirkonio dernière génération par PVD

- Base ZRN
- Faible coefficient friction
- Résistant à l'usure
- Recommandé pour aciers non ferreux
- Évite l'adhérence sur les filets de coupe

D	L	I	📦	N°	€
mm	mm	mm		Art.	
1,00	34	12	10	59101	1,66
1,10	36	14	10	62815	1,94
1,20	38	16	10	62819	1,94
1,25	38	16	10	68271	1,94
1,30	38	16	10	62820	1,94
1,40	40	18	10	62821	1,94
1,50	40	18	10	59103	1,50
1,60	43	20	10	62822	1,94
1,70	43	20	10	62823	1,94
1,75	46	22	10	68274	1,74
1,80	46	22	10	62824	1,94
1,90	46	22	10	62826	1,94
2,00	49	24	10	59100	1,57
2,10	49	24	10	62827	1,82
2,20	53	27	10	62828	1,82
2,25	53	27	10	68363	1,67
2,30	53	27	10	62829	1,82
2,40	57	30	10	62830	1,82
2,50	57	30	10	59104	1,41
2,60	57	30	10	62831	1,77

D	L	I	📦	N°	€
mm	mm	mm		Art.	
2,70	61	33	10	62832	1,77
2,75	61	33	10	68364	1,50
2,80	61	33	10	62833	1,77
2,90	61	33	10	62834	1,77
3,00	61	33	10	59115	1,38
3,10	65	36	10	62835	1,70
3,20	65	36	10	59118	1,70
3,25	65	36	10	59121	1,70
3,30	65	36	10	59124	1,70
3,40	70	39	10	62836	1,77
3,50	70	39	10	59127	1,67
3,60	70	39	10	62837	2,13
3,70	70	39	10	62838	2,13
3,75	70	39	10	68365	1,85
3,80	75	43	10	62839	2,13
3,90	75	43	10	62841	2,13
4,00	75	43	10	59131	1,79
4,10	75	43	10	62842	1,88
4,20	75	43	10	59133	1,88
4,25	75	43	10	59134	1,88

D	L	I	📦	N°	€
mm	mm	mm		Art.	
4,30	80	47	10	62843	2,01
4,40	80	47	10	62844	2,01
4,50	80	47	10	59137	1,95
4,60	80	47	10	62845	2,24
4,70	80	47	10	62846	2,24
4,75	80	47	10	68350	2,00
4,80	86	52	10	62847	2,24
4,90	86	52	10	62848	2,24
5,00	86	52	10	58831	2,03
5,10	86	52	10	62849	2,42
5,20	86	52	10	59139	2,42
5,25	86	52	10	68366	2,33
5,30	86	52	10	62850	2,42
5,40	93	57	10	62851	2,42
5,50	93	57	10	59140	2,58
5,60	93	57	10	62852	3,08
5,70	93	57	10	62853	3,08
5,75	93	57	10	68367	2,99
5,80	93	57	10	62854	3,08
5,90	93	57	10	62855	3,08



Ref. **1015**

BROCA MANGO CILÍNDRICO ZIRKONIO

Zirkonio Straight Shank Drill Bit
Foret queue cylindrique Zirkonio

Cont.

D mm	L mm	I mm		Nº Art.	€	D mm	L mm	I mm		Nº Art.	€	D mm	L mm	I mm		Nº Art.	€
6,00	93	57	10	59145	2,74	8,30	117	75	5	62873	5,99	10,80	142	94	5	62895	13,28
6,10	101	63	10	62856	3,41	8,40	117	75	5	62874	5,99	10,90	172	94	5	62896	13,28
6,20	101	63	10	62857	3,41	8,50	117	75	5	59158	4,69	11,00	142	94	5	59170	10,65
6,25	101	63	10	68368	3,17	8,60	125	81	5	62875	7,61	11,10	142	94	5	62898	15,10
6,30	101	63	10	62858	3,41	8,70	125	81	5	62876	7,61	11,20	142	94	5	62900	15,10
6,40	101	63	10	62859	3,41	8,75	125	81	5	68373	5,82	11,30	142	94	5	62902	15,10
6,50	101	63	10	59148	3,30	8,80	125	81	5	62877	7,61	11,40	142	94	5	62904	15,10
6,60	101	63	10	62860	4,08	8,90	125	81	5	62878	7,61	11,50	142	94	5	59172	12,72
6,70	101	63	10	62861	4,08	9,00	125	81	5	59161	5,97	11,60	172	94	5	62905	15,65
6,75	109	69	10	68369	3,08	9,10	125	81	5	62879	8,45	11,70	142	94	5	62907	15,65
6,80	109	69	10	59149	3,83	9,20	125	81	5	62880	8,45	11,80	142	94	5	62908	15,65
6,90	109	69	10	62862	4,08	9,25	125	81	5	68374	6,51	11,90	151	101	5	62909	15,65
7,00	109	69	10	59151	3,59	9,30	125	81	5	62881	8,45	12,00	151	101	5	59173	13,62
7,10	109	69	10	62863	5,20	9,40	125	81	5	62882	8,45	12,10	151	101	5	62910	18,13
7,20	109	69	10	62864	5,20	9,50	125	81	5	59163	6,18	12,20	151	101	5	62918	18,13
7,25	109	69	10	68370	4,25	9,60	133	87	5	62883	9,94	12,30	151	101	5	62921	18,13
7,30	109	69	10	62865	5,20	9,70	133	87	5	62884	9,94	12,40	151	101	5	62923	18,13
7,40	109	69	10	62866	5,20	9,75	133	87	5	68375	7,26	12,50	151	101	5	59176	16,56
7,50	109	69	10	59155	3,83	9,80	133	87	5	62886	9,94	12,60	151	101	5	62927	18,92
7,60	117	75	10	62867	6,28	9,90	133	87	5	62887	9,94	12,70	151	101	5	62930	18,92
7,70	117	75	10	62868	6,28	10,00	133	87	5	59164	6,79	12,80	151	101	5	62932	18,92
7,75	117	75	10	68371	4,85	10,10	133	87	5	62888	11,42	12,90	151	101	5	62934	18,92
7,80	117	75	10	62869	6,28	10,20	133	87	5	59166	9,63	13,00	151	101	5	59179	16,95
7,90	117	75	10	62870	6,28	10,30	133	87	5	62889	11,42	New! 13,50	160	108	1	25147	23,18
8,00	117	75	10	59157	4,49	10,40	133	87	5	62890	11,42	New! 14,00	160	108	1	25154	24,85
8,10	117	75	5	62871	5,99	10,50	133	87	5	59167	9,63	New! 14,50	169	114	1	25155	26,72
8,20	117	75	5	62872	5,99	10,60	133	87	5	62892	13,28	New! 15,00	169	114	1	25156	27,05
8,25	117	75	5	68372	4,51	10,70	142	94	5	62893	13,28	New! 16,00	178	120	1	25157	32,96

Expo - Ref. 1015



Cuartos / Quarters / Quarts

Ø	1	1,5	2	2,5	3	3,25
Pcs	10	10	30	10	50	10
Ø	3,5	4	4,25	4,5	5	
Pcs	10	50	10	10	40	
Ø	5,5	6	6,5	7		
Pcs	10	50	10	10		
Ø	7,5	8	8,5	9		
Pcs	10	20	10	10		
Ø	9,5	10	11	12	13	
Pcs	5	10	5	5	5	

Nº Art. 15999: 1.175,80 €

Previos Roscado / Before Threading / Pré-Taraudage

Ø	1	1,5	2	2,5	3	3,3	
Pcs	10	10	30	10	50	10	
Ø	3,5	4	4,2	4,5	5		
Pcs	10	50	10	10	40		
Ø	5,5	6	6,5	6,8			
Pcs	10	50	10	10			
Ø	7	7,5	8	8,5			
Pcs	10	10	20	10			
Ø	9	9,5	10	10,2	11	12	13
Pcs	10	5	10	5	5	5	5

Nº Art. 16001: 1.262,25 €



Línea 1 m - Ref. 1015



Cuartos / Quarters / Quarts

1,5 10	3 50	4 50	5 40	6 50	7 10	8 20	9 10	10 10	12 5	mm pcs
	2,5 10	3,5 10	4,5 10							
1 10	2 30	3,25 10	4,25 10	5,5 10	6,5 10	7,5 10	8,5 10	9,5 5	11 5	13 5

Nº Art. 71396: **1.175,80 €**

Previos Roscado / Before Threading / Pré-Tarudage

1,5 10	3 50	4 50	5 40	6 50	7 10	8 20	9,5 5	10,2 5	12 5	mm pcs
	2,5 10	3,5 10	4,5 10		6,8 10		9 10			
1 10	2 30	3,3 10	4,2 10	5,5 10	6,5 10	7,5 10	8,5 10	10 10	11 5	13 5

Nº Art. 71638: **1.262,25 €**



Expo - Ref. 1015



200 Pcs

∅	1	1,5	2	2,5	3	3,5	4	4,5		
Pcs	10	10	10	10	10	10	10	10		
∅	5		5,5		6		6,5		7	
Pcs	10		10		10		10		10	
∅	7,5			8		8,5		9		
Pcs	10			10		5		5		
∅	9,5			10		10,5		11		
Pcs	5			5		5		5		
∅	11,5			12		12,5		13		
Pcs	5			5		5		5		

Nº Art. 14229: **873,70 €**

Ref. **1065**

BROCA MANGO CILÍNDRICO ZIRKONIO

Zirkonio Straight Shank Drill Bit
Foret queue cylindrique Zirkonio

New!

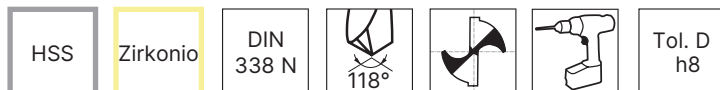

D mm	L mm	I mm		Nº Art.	€
1,00	34	12	2	14509	3,83 *
1,50	40	18	2	14547	3,44 *
2,00	49	24	2	14592	3,58 *
2,50	57	30	2	14640	3,24 *
3,00	61	33	2	14682	3,17 *
3,25	65	36	2	14694	3,90 *
3,30	65	36	2	14700	3,90 *
3,50	70	39	2	14731	3,85 *
4,00	75	43	2	14734	4,12 *
4,20	75	43	1	14743	2,17
4,25	75	43	1	14749	2,17
4,50	80	47	1	14757	2,22
5,00	86	52	1	14758	2,35
5,50	93	57	1	14772	2,97
6,00	93	57	1	14776	3,14
6,50	101	63	1	14784	3,63

D mm	L mm	I mm		Nº Art.	€
New! 6,80	109	69	1	25971	4,21
7,00	109	69	1	14787	3,96
7,50	109	69	1	14794	4,21
8,00	117	75	1	14796	4,93
8,50	117	75	1	14799	5,14
9,00	125	81	1	14805	6,57
9,50	125	81	1	14809	6,79
10,00	133	87	1	14811	7,13
10,20	133	87	1	14812	10,11
10,50	133	87	1	14814	10,11
11,00	142	94	1	14818	11,17
11,50	142	94	1	14821	13,35
12,00	151	101	1	14823	14,30
New! 12,50	151	101	1	40206	17,39
13,00	151	101	1	14824	17,81

* € = 2 uds.

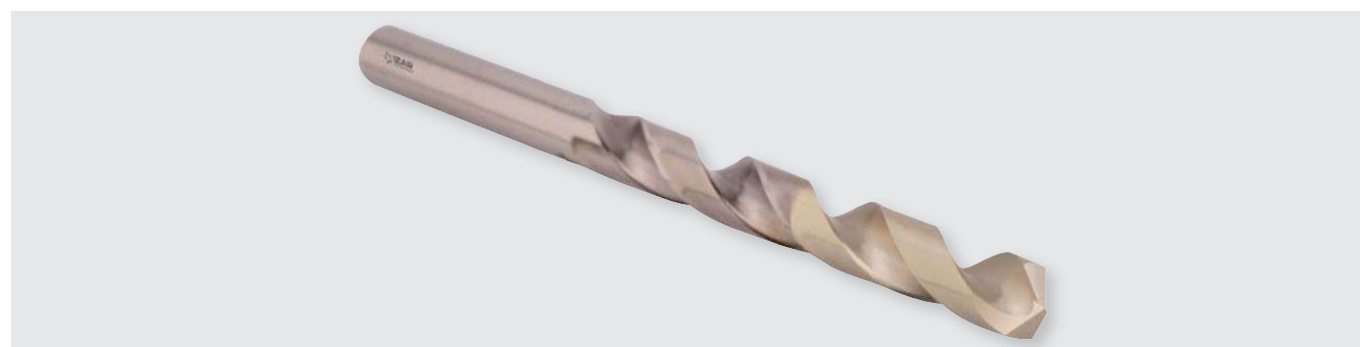



Set 1462

6 Pcs

Cont. Ø	Nº Art.	€
2 - 3 - 4 - 5 - 6 - 8 mm	59236	14,84



New!

Set 1459

29 Pcs

Cont. Ø	Nº Art.	€
1 - 13 x 0,5 mm *	15115	159,43

* + Previos Roscado Before Threading Pré-Tarudage (3,3 - 4,2 - 6,8 - 10,2 mm)

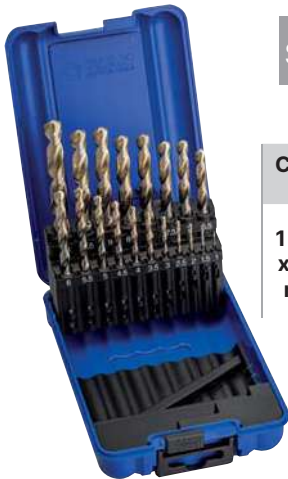

Set 1466

19 Pcs

Cont. Ø	Nº Art.	€
1 - 10 x 0,5 mm	59234	61,48



Set 1456

25 Pcs

Cont. Ø	Nº Art.	€
1 - 13 x 0,5 mm	59235	142,36



Box-Pallet 1015

5 Sets 1466

Cont. Set	Nº Art.	€
1 - 10 x 0,5 mm	80662	292,03



Box-Pallet 1015

5 Sets 1456

Cont. Set	Nº Art.	€
1 - 13 x 0,5 mm	80678	676,21

Set 1405



New!

50 Pcs

Cont. Ø	Nº Art.	€
1 - 5,9 × 0,1 mm	59126	111,53

Set 1408



New!

41 Pcs

Cont. Ø	Nº Art.	€
6 - 10 × 0,1 mm	59129	263,37

Set 1406

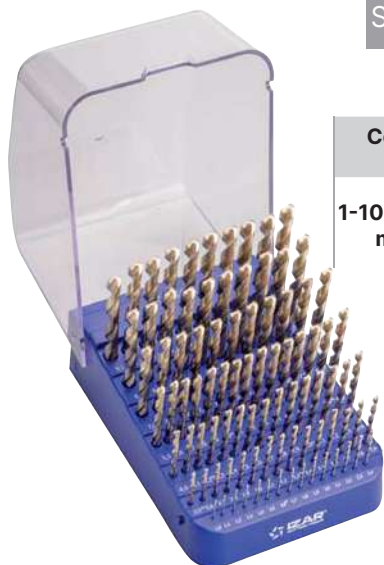

91 Pcs

Cont. Ø	Nº Art.	€
1-10 × 0,10 mm	56686	354,78

Set 1404

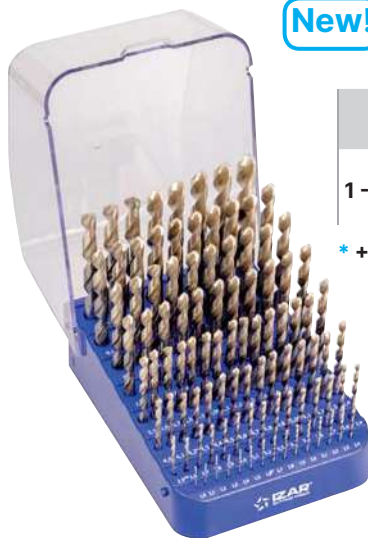

New!

99 Pcs

Cont. Ø	Nº Art.	€
1 - 10 × 0,10 mm *	48824	461,40

* + Previos Roscado / Before Threading
Pré-Taraudage (< 13 mm)

Set 1410

NOVABOX

New!



55 Pcs

Cont. Ø	Nº Art.	€
1 - 13 × 0,5 mm	28360	241,82
Ø1,0 - 4,0 mm: 3 pcs		
Ø4,2 - 8,0 mm: 2 pcs		
Ø8,50 - 13,0 mm: 1 pcs		





Ref. **1010**

BROCA MANGO CILÍNDRICO HSS

HSS Straight Shank Drill Bit
Foret queue cylindrique HSS



CLASSIQUE



HSS	HSS + TIN	DIN 338 N			Usos General General Purpose Utilisation générale
-----	-----------	-----------	--	--	--

Aceros <850 N/mm² Steel / Aciers	Fundición Cast Iron Fonte	Aluminio Aluminium
---	--	-------------------------------------



D mm	L mm	I mm		Nº Art. HSS	€	Nº Art. TIN	€	D mm	L mm	I mm		Nº Art. HSS	€	Nº Art. TIN	€
0,30	19	3	10	17996	2,02			2,20	53	27	10	10043	0,77	18338	1,71
0,35	19	4	10	17999	2,08			2,25	53	27	10	10046	0,72	18341	1,66
0,40	20	5	10	18002	2,02			2,30	53	27	10	10049	0,91	18344	1,83
0,45	20	5	10	18005	2,02			2,35	53	27	10	18080	0,91		
0,50	22	6	10	18008	1,42			2,40	57	30	10	10052	0,91	18347	1,83
0,55	24	7	10	18011	1,79			2,45	57	30	10	18083	0,91		
0,60	24	7	10	18014	1,79			2,50	57	30	10	10055	0,75	18350	1,72
0,65	26	8	10	18017	1,79			New! 2,55	57	30	10	18086	0,93	24315	1,84
0,70	28	9	10	18020	1,79			2,60	57	30	10	10058	0,93	18353	1,84
0,75	28	9	10	18023	1,31			2,65	57	30	10	18089	0,93		
0,80	30	10	10	18026	1,34			2,70	61	33	10	10061	0,93	27166	1,84
0,85	30	10	10	18029	1,34			2,75	61	33	10	10064	0,79	18356	1,78
0,90	32	11	10	18032	1,34			2,80	61	33	10	10067	0,93	18359	1,84
0,95	32	11	10	18035	1,34			2,85	61	33	10	18092	0,93		
1,00	34	12	10	10001	1,04	18305	2,08	2,90	61	33	10	10070	0,93	27088	1,84
New! 1,05	34	12	10	18038	1,15	53352	2,10	2,95	61	33	10	18095	0,93		
1,10	36	14	10	10004	1,15	15056	2,10	3,00	61	33	10	10073	0,68	18362	1,61
1,15	36	14	10	18041	1,15			3,05	65	36	10	18098	0,90	17358	2,09
1,20	38	16	10	10007	1,15	18308	2,10	3,10	65	36	10	10076	0,79	18365	2,05
1,25	38	16	10	10010	0,92	27087	1,95	3,15	65	36	10	27343	0,90	29078	2,09
1,30	38	16	10	10013	1,02	18311	2,02	3,20	65	36	10	10079	0,79	18368	2,05
1,35	40	18	10	18050	1,02			3,25	65	36	10	10082	0,79	18371	2,05
1,40	40	18	10	10016	1,02	27337	2,02	3,30	65	36	10	10085	0,79	18374	2,05
1,45	40	18	10	18053	1,02			New! 3,35	65	36	10	27345	1,02	24316	2,18
1,50	40	18	10	10019	0,79	18314	1,78	3,40	70	39	10	10088	1,03	27322	2,19
1,55	43	20	10	18059	0,98			3,45	70	39	10	27346	1,03	21777	2,19
1,60	43	20	10	10022	0,98	18317	1,99	3,50	70	39	10	10091	0,77	18377	2,01
1,65	43	20	10	18062	0,98			3,55	70	39	10	18101	1,06		
1,70	43	20	10	10025	0,98	18320	1,99	3,60	70	39	10	10094	1,06	27323	2,22
1,75	46	22	10	10028	0,88	18323	1,94	3,65	70	39	10	18104	1,06		
1,80	46	22	10	10031	0,88	18326	1,90	3,70	70	39	10	10097	1,06	18380	2,22
New! 1,85	46	22	10	18068	0,88	77801	1,90	3,75	70	39	10	10100	0,91	18383	2,14
1,90	46	22	10	10034	0,88	18329	1,90	3,80	75	43	10	10103	1,09	18386	2,25
1,95	49	24	10	18071	0,88			3,85	75	43	10	18107	1,09	79546	2,25
2,00	49	24	10	10037	0,75	18332	1,78	3,90	75	43	10	10106	1,09	27165	2,25
New! 2,05	49	24	10	18074	0,77	14277	1,71	3,95	75	43	10	18110	1,09		
2,10	49	24	10	10040	0,77	18335	1,71	4,00	75	43	10	10109	0,89	18389	2,11
2,15	53	27	10	18077	0,77			4,05	75	43	10	27349	1,09		







Ref. **1010**

BROCA MANGO CILÍNDRICO HSS

HSS Straight Shank Drill Bit
Foret queue cylindrique HSS

D mm	L mm	I mm		Nº Art. HSS	€	Nº Art. TIN	€
4,10	75	43	10	10112	0,98	18392	2,19
4,15	75	43	10	27350	1,09		
4,20	75	43	10	10115	0,98	18395	2,19
4,25	75	43	10	10118	0,98	18398	2,19
4,30	80	47	10	10121	1,30	18401	2,43
4,35	80	47	10	18113	1,30		
4,40	80	47	10	10124	1,30	18404	2,43
4,45	80	47	10	18116	1,30		
4,50	80	47	10	10127	1,02	18407	2,23
4,55	80	47	10	27288	1,31		
4,60	80	47	10	10130	1,31	18410	2,45
4,65	80	47	10	27352	1,31		
4,70	80	47	10	10133	1,31	18413	2,45
4,75	80	47	10	10136	1,15	18416	2,35
4,80	86	52	10	10139	1,46	18419	2,59
4,85	86	52	10	18119	1,43		
4,90	86	52	10	10142	1,43	18422	2,55
4,95	86	52	10	18122	1,43		
5,00	86	52	10	10145	1,08	18425	2,27
5,05	86	52	10	18125	1,47	21749	2,58
5,10	86	52	10	10148	1,47	18428	2,58
5,15	86	52	10	27330	1,47		
5,20	86	52	10	10151	1,47	18431	2,58
5,25	86	52	10	10154	1,38	18434	2,57
5,30	86	52	10	10157	1,82	18437	2,92
5,35	93	57	10	18131	1,82		
5,40	93	57	10	10160	1,82	27292	2,92
5,45	93	57	10	27354	1,82		
5,50	93	57	10	10163	1,44	18440	2,63
5,55	93	57	10	27356	1,95	65683	3,04
5,60	93	57	10	10166	1,95	18443	3,04
5,65	93	57	10	18134	1,95		
5,70	93	57	10	10169	1,95	18446	3,04
5,75	93	57	10	10172	1,86	18449	3,03
5,80	93	57	10	10175	1,82	18452	2,92
5,85	93	57	10	27357	1,82		
5,90	93	57	10	10178	1,82	18455	2,92
5,95	93	57	10	27358	1,82		
6,00	93	57	10	10181	1,49	18458	2,65
6,05	101	63	10	27359	2,10	17594	5,26
6,10	101	63	10	10184	2,10	18461	5,26
6,15	101	63	10	27360	2,10	79817	5,26
6,20	101	63	10	10187	2,10	18464	5,26
6,25	101	63	10	10190	2,00	18467	5,26
6,30	101	63	10	10193	2,21	27324	5,34
6,35	101	63	10	27361	2,21		
6,40	101	63	10	10196	2,29	18470	5,43
New! 6,45	101	63	10	18137	2,21	24317	5,50
6,50	101	63	10	10199	1,72	18473	5,02
6,55	101	63	10	18140	2,77		
New! 6,60	101	63	10	10202	2,77	18476	5,86
6,65	101	63	10	27362	2,77	24318	5,86
6,70	101	63	10	10205	2,77	27333	5,86
6,75	109	69	10	10208	2,08	18479	5,36
6,80	109	69	10	10211	2,08	18482	5,36
6,85	109	69	10	18143	3,06		
6,90	109	69	10	10214	3,06	18485	6,12
6,95	109	69	10	27316	3,06		
7,00	109	69	10	10217	2,08	18488	5,36
7,05	109	69	10	27363	3,22	79818	6,31

D mm	L mm	I mm		Nº Art. HSS	€	Nº Art. TIN	€
7,10	109	69	10	10220	3,22	18491	6,31
7,15	109	69	10	27364	3,22		
7,20	109	69	10	10223	3,22	18494	6,31
7,25	109	69	10	10226	2,66	18497	5,88
7,30	109	69	10	10229	3,22	18500	6,31
7,35	109	69	10	27365	3,22		
7,40	109	69	10	10232	3,22	27150	6,31
7,45	109	69	10	27366	3,32		
7,50	109	69	10	10235	2,20	18503	5,48
7,55	117	75	10	27369	3,83		
7,60	117	75	10	10238	3,83	27313	6,91
7,65	117	75	10	27368	3,83		
7,70	117	75	10	10241	3,83	18506	6,91
7,75	117	75	10	10244	2,97	27272	6,25
7,80	117	75	10	10247	3,87	18509	6,93
7,85	117	75	10	27370	3,87		
7,90	117	75	10	10250	3,87	18512	6,93
7,95	117	75	10	27372	3,87		
8,00	117	75	10	10253	2,52	18515	5,77
8,05	117	75	10	27373	3,96	39695	7,58
8,10	117	75	10	10256	3,96	26675	7,58
8,15	117	75	10	27374	3,96		
8,20	117	75	10	10259	3,96	26678	7,58
8,25	117	75	10	10262	2,97	18518	6,83
8,30	117	75	10	10265	4,12	27311	7,74
8,35	117	75	10	27376	4,12		
8,40	117	75	10	10268	4,12	26681	7,74
8,45	117	75	10	27377	4,12		
8,50	117	75	10	10271	2,73	18521	6,53
8,55	125	81	10	27378	5,17		
8,60	125	81	10	10274	5,17	18524	8,71
8,65	125	81	10	27379	5,17		
8,70	125	81	10	10277	5,17	18527	8,71
8,75	125	81	10	10280	3,98	18530	7,75
8,80	125	81	10	10283	5,19	18533	8,72
8,85	125	81	10	27381	5,19		
8,90	125	81	10	10286	5,19	18536	8,72
8,95	125	81	10	27383	5,19		
9,00	125	81	10	10289	3,34	18539	7,06
9,05	125	81	10	27382	5,22		
9,10	125	81	10	10292	5,22	26684	8,76
9,15	125	81	10	27385	5,22		
9,20	125	81	10	10295	5,22	27553	8,76
9,25	125	81	10	10298	4,01	27273	7,79
9,30	125	81	10	10301	4,89	18542	8,45
9,35	125	81	10	27556	5,39		
9,40	125	81	10	10304	4,89	27149	8,45
9,45	125	81	10	27387	4,89		
9,50	125	81	10	10307	3,63	18545	7,35
9,55	133	87	10	27389	6,23		
9,60	133	87	10	10310	6,23	26687	9,70
9,65	133	87	10	27390	6,23		
9,70	133	87	10	10313	6,23	27151	9,70
9,75	133	87	10	10316	4,52	18548	8,27
9,80	133	87	10	10319	6,13	18551	9,60
9,85	133	87	10	27391	6,13		
9,90	133	87	10	10322	6,13	18554	9,60
9,95	133	87	10	27393	6,13		
10,00	133	87	10	10325	3,89	18557	7,62
10,10	133	87	5	10328	5,22	29149	13,27





Ref. **1010**

BROCA MANGO CILÍNDRICO HSS

HSS Straight Shank Drill Bit
Foret queue cylindrique HSS

D mm	L mm	I mm		Nº Art. HSS	€	Nº Art. TIN	€	D mm	L mm	I mm		Nº Art. HSS	€	Nº Art. TIN	€
10,20	133	87	5	10331	4,87	18560	12,92	13,80	160	108	1	18176	15,66	24664	25,66
10,25	133	87	5	10334	5,44	27274	13,48	13,90	160	108	1	10451	15,66	68188	25,66
10,30	133	87	5	10337	6,09	29151	13,78	14,00	160	108	1	10454	11,65	29007	21,79
10,40	133	87	5	10340	6,09			14,10	169	114	1	18179	16,69		
10,50	133	87	5	10343	4,87	18563	12,62	14,20	169	114	1	18185	16,69		
10,60	133	87	5	10346	6,72	29154	14,00	14,25	169	114	1	10457	13,67	29194	23,64
10,70	142	94	5	10349	6,72			14,30	169	114	1	18188	17,00		
10,75	142	94	5	10352	6,30	27277	13,94	14,40	169	114	1	18191	17,00		
10,80	142	94	5	10355	7,45	29157	14,69	14,50	169	114	1	10460	12,57	29198	22,59
10,90	142	94	5	10358	7,45			14,60	169	114	1	18194	17,30		
11,00	142	94	5	10361	5,68	18566	13,36	14,70	169	114	1	18197	17,30		
11,10	142	94	5	10364	7,57			14,75	169	114	1	10463	13,67	29202	23,64
11,20	142	94	5	10367	7,57			14,80	169	114	1	18200	16,69		
11,25	142	94	5	10370	6,43	26801	14,05	14,90	169	114	1	18203	16,69		
New! 11,30	142	94	5	10373	7,45	27448	15,06	15,00	169	114	1	10466	12,70	29205	22,76
11,40	142	94	5	10376	7,45	27450	15,06	15,20	178	120	1	18209	21,90		
11,50	142	94	5	10379	6,07	18569	13,72	15,25	178	120	1	10469	18,64	29209	28,26
11,60	142	94	5	10382	7,45			15,50	178	120	1	10472	14,86	29213	24,77
11,70	142	94	5	10385	7,45			15,60	178	120	1	18218	25,63		
11,75	142	94	5	10388	6,43	27275	14,05	15,70	178	120	1	18221	25,63		
11,80	142	94	5	10391	8,14	29166	15,69	15,75	178	120	1	10475	18,89		
11,90	151	101	5	10394	8,14	29167	15,69	15,80	178	120	1	18224	23,92		
12,00	151	101	5	10397	6,75	18572	14,36	15,90	178	120	1	18227	23,92		
12,10	151	101	5	10400	9,50	29169	18,57	16,00	178	120	1	10478	15,47	29220	25,32
12,20	151	101	5	10403	9,50			16,20	184	125	1	27289	32,74		
12,25	151	101	5	10406	8,37	18578	17,92	16,25	184	125	1	10481	27,84		
New! 12,30	151	101	5	10409	8,94	24144	18,49	16,50	184	125	1	10484	18,00	12861	27,01
12,40	151	101	5	10412	8,94			16,75	184	125	1	10487	29,10	19368	37,77
12,50	151	101	5	10415	7,43	18581	17,01	16,80	184	125	1	27676	43,98	19369	52,24
12,60	151	101	5	10418	9,27			17,00	184	125	1	10490	18,00	12866	27,02
12,70	151	101	5	10421	9,27			17,25	191	130	1	10493	30,21		
12,75	151	101	5	10424	8,25	27276	17,80	17,50	191	130	1	10496	20,69	12862	29,62
12,80	151	101	5	10427	10,34			17,75	191	130	1	10499	33,45		
12,90	151	101	5	10430	10,34			18,00	191	130	1	10502	21,88	29236	29,89
13,00	151	101	5	10433	7,68	18584	17,28	18,25	198	135	1	10505	32,81		
13,10	151	101	1	10436	10,57			New! 18,50	198	135	1	10508	24,30	10794	33,66
13,20	151	101	1	18164	10,57			18,75	198	135	1	10511	33,74		
13,25	160	108	1	10439	12,06	29180	22,16	19,00	198	135	1	10514	24,30	14065	33,66
13,30	160	108	1	18167	16,37			19,25	205	140	1	10517	44,16		
13,40	160	108	1	18170	16,37			19,50	205	140	1	10520	26,05		
13,50	160	108	1	10442	10,88	29184	21,05	19,75	205	140	1	10523	42,83		
13,60	160	108	1	18173	16,37			New! 20,00	205	140	1	10526	29,68	14076	37,48
13,70	160	108	1	10445	16,37										
13,75	160	108	1	10448	12,23	16497	22,34								

Ref. **1050**



Extra-Corta / Stub / Extra-courte

Pag 81

Ref. **1030**



Larga / Long / Longue

Pag 82

Ref. **1040**



Extra Larga / Extra Long / Extra-longue Pag 86



Expo - Ref. 1010



Cuartos / Quarters / Quarts

∅	1	1,5	2	2,5	3	3,25
Pcs	30	20	40	30	80	20
∅	3,5	4	4,25	4,5	5	
Pcs	20	60	10	20	80	
∅	5,5	6	6,5	7		
Pcs	10	60	20	20		
∅	7,5	8	8,5	9		
Pcs	10	40	10	10		
∅	9,5	10	11	12	13	
Pcs	10	30	15	20	10	

Nº Art. 57523: **1.168,40 €**

Previos Roscado / Before Threading / Pré-Taraudage

∅	1	1,5	2	2,5	3	3,3
Pcs	30	20	40	30	80	20
∅	3,5	4	4,2	4,5	5	
Pcs	20	60	10	20	80	
∅	5,5	6	6,5	6,8		
Pcs	10	60	20	10		
∅	7	7,5	8	8,5		
Pcs	20	10	40	10		
∅	9	9,5	10	10,2	11	12
Pcs	10	10	30	10	15	20
						13
						10

Nº Art. 57975: **1.237,90 €**

Línea 1 m - Ref. 1010

Cuartos / Quarters / Quarts

1,5 20	3 80	4 60	5 80	6 60	7 20	8 40	9 10	10 30	12 20	mm pcs
	2,5 30	3,5 20	4,5 20							
1 30	2 40	3,25 20	4,25 10	5,5 10	6,5 20	7,5 10	8,5 10	9,5 10	11 15	13 10

Nº Art. 70965: **1.168,40 €**

Previos Roscado / Before Threading / Pré-Taraudage

1,5 20	3 80	4 60	5 80	6 60	7 20	8 40	9,5 10	10,2 10	12 20	mm pcs
	2,5 30	3,5 20	4,5 20		6,8 10		9 10			
1 30	2 40	3,3 20	4,2 10	5,5 10	6,5 20	7,5 10	8,5 10	10 30	11 15	13 10

Nº Art. 70999: **1.237,90 €**



Expo - Ref. 1010



400 Pcs

∅	1	1,5	2	2,5	3	3,5	4	4,5
Pcs	10	10	20	20	50	30	40	20
∅	5	5,5	6	6,5	7			
Pcs	40	10	30	10	10			
∅	7,5	8	8,5	9				
Pcs	10	20	10	10				
∅	9,5	10	10,5	11				
Pcs	10	10	5	5				
∅	11,5	12	12,5	13				
Pcs	5	5	5	5				

N° Art. 55440: **702,40 €**

Ref. **1001**

BROCA MANGO CILÍNDRICO HSS

HSS Straight Shank Drill Bit
Foret queue cylindrique HSS



CLASSIQUE



HSS

HSS
+
TIN

DIN
338 N



Usos General
General Purpose
Utilisation générale

Aceros
<850 N/mm²
Steel / Aciers

Fundición
Cast Iron
Fonte

Aluminio
Aluminium

D mm	L mm	I mm		Nº Art. HSS	€	Nº Art. TIN	€
1,00	34	12	2	18781	2,47	16527	4,92 *
1,50	40	18	2	18783	1,85	16528	4,23 *
2,00	49	24	2	18792	1,78	16529	4,23 *
2,50	57	30	2	18793	1,78	16530	4,07 *
3,00	61	33	2	18687	1,61	16531	3,85 *
3,25	65	36	2	30156	1,83	16532	4,75 *
3,30	65	36	2	34039	1,83		*
3,50	70	39	2	18688	1,79	16533	4,67 *
4,00	75	43	2	18589	2,03	16534	4,88 *
4,20	75	43	1	34040	1,14		
4,25	75	43	1	30157	1,14	16535	2,52
4,50	80	47	1	18591	1,15	16536	2,55
5,00	86	52	1	18592	1,24	16537	2,63
5,50	93	57	1	18594	1,66	16538	3,01
6,00	93	57	1	18595	1,71	16539	3,06
6,50	101	63	1	18597	1,94	16540	5,60
6,80	109	69	1	34041	2,36		
7,00	109	69	1	18645	2,36	16541	5,98
7,50	109	69	1	18646	2,44	16542	6,10
8,00	117	75	1	18655	2,81	16543	6,42
8,50	117	75	1	18657	3,04	16544	7,27
9,00	125	81	1	18666	3,70	16545	7,87
9,50	125	81	1	66989	3,92		
10,00	133	87	1	18667	4,19	16546	8,24
10,20	133	87	1	34042	5,26		
10,50	133	87	1	66991	5,26		
11,00	142	94	1	30158	6,12	16547	14,44
11,50	142	94	1	66993	6,56		
12,00	151	101	1	18676	7,28	16549	15,54
12,50	151	101	1	66995	8,01		
13,00	151	101	1	30159	8,27	16550	18,68



* € = 2 uds.



Línea 1 m - Ref. 1001



∅	1	1,5	2	2,5	3	3,25	3,5	4	4,25	4,5	5	5,5	6	6,5	7	7,5	8	9	10	
Packs	10	10	10	10	10	10	10	10	10	10	10	10	10	10	10	10	10	10	10	10

Ref. 4995 - Nº Art. 70942: **394,80 €**

Display 14 - Ref. 1001



∅	7,5	8	8,5	9	10	11	12	13		
Packs	5	5	5	5	3	3	3	3		
∅	4	4,25	4,5	5	5	5,5	6	6	6,5	7
Packs	10	10	10	10	10	5	5	5	5	5
∅	1	1,5	2	2,5	3	3	3,25	3,5	3,5	4
Packs	10	10	10	10	10	10	10	10	10	10

Ref. 4995 - Nº Art. 22162: **437,83 €**

Display 46 - Ref. 1001 + PREVIOS ROSCADO + Before Threading + Pré-Tarudage



∅	8	8,5	9	10	10,2	11	12	13		
Packs	5	5	5	3	3	3	3	3		
∅	4,25	4,5	5	5	5,5	6	6,5	6,8	7	7,5
Packs	15	8	8	7	5	10	5	5	5	5
∅	1	1,5	2	2,5	3	3,25	3,3	3,5	4	4,2
Packs	10	10	10	10	10	10	8	10	10	8

Ref. 4995 - Nº Art. 55618: **432,07 €**

Display 51 - Refs. 1880 - 1640 - 1001

BROCAS METAL + PARED + MADERA

Metal + Masonry + Wood Drill Bits

Forets Métal + Maçonnerie + Bois



Ref. 1880	∅	3	4	5	6	7	8	9	10	12	14
	Pcs	10	10	10	10	10	10	5	5	5	5
Ref. 1640	∅	3	4	5	6	8	9	10	12	14	16
	Pcs	10	10	10	10	10	5	5	5	5	5
Ref. 1001	∅	1	2	3	3,5	4	4,5	5	6	8	10
	Pcs	10	10	10	10	10	10	10	5	5	3

Ref. 4995 - N° Art. 68572: 363,47 €

Display 24 - Refs. 1016 - 1010

SETS BROCAS MANGO CILINDRICO HSS + HSSE

HSS + HSSE Straight Shank Drill Bit Sets

Jeux forets queue cylindrique HSS + HSSE



HSSE	Set 1462 - Ref. 1016 Metal Pro 5 Pcs.	Set 1466 - Ref. 1016 Metal Pro 19 Pcs.	Set 1456 - Ref. 1016 Metal Pro 25 Pcs.
	Pcs 5	Pcs 1	Pcs 1
HSS	Set 1462 - Ref. 1010 Metal 5 Pcs.	Set 1466 - Ref. 1010 Metal 19 Pcs.	Set 1456 - Ref. 1010 Metal 25 Pcs.
	Pcs 5	Pcs 2	Pcs 2

Ref. 4995 - N° Art. 22320: 530,93 €

Línea 33 cm - 14S1

SETS BROCAS METAL, PARED PRO, PARED, MADERA

Metal, Concrete, Masonry, Wood Sets

Jeux Métal, Béton, Maçonnerie, Bois



	Metal Metal Métal	Pared Pro Concrete Béton	Pared Masonry Maçonnerie	Madera Wood Bois
Ref	Set 1462 - Ref. 1010	Set 1486 - Ref. 1886	Set 1485 - Ref. 1880	Set 1435 - Ref. 1640
Diam	2-3-4-5-6-8 mm	4-5-6-8-10 mm	4-5-6-8-10 mm	4-5-6-8-10 mm
Pcs.	5	5	5	5

Ref. 4995 - N° Art. 72193: 186,25 €





Set **1462**
6 Pcs

Cont. Ø	Nº Art.	€
2 - 3 - 4 - 5 - 6 - 8 mm	30230	8,25



New!

Set **1459**
29 Pcs

Cont. Ø	Nº Art.	€
1 - 13 x 0,5 mm *	15070	83,15

* + Previos Roscado / Before Threading
Pré-Taraudage (3,3 - 4,2 - 6,8 - 10,2 mm)



Set **1466**
19 Pcs

Cont. Ø	Nº Art.	€
1 - 10 x 0,5 mm	25271	35,17

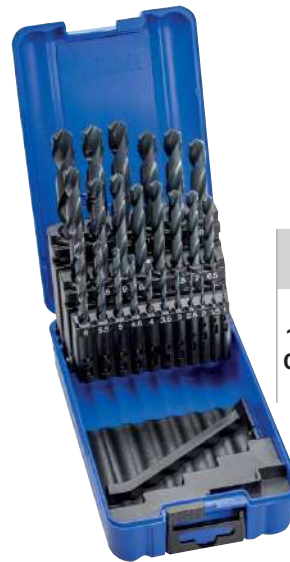

Set **1456**
25 Pcs

Cont. Ø	Nº Art.	€
1 - 13 x 0,5 mm	25235	74,40



Box-Pallet
1010

5 Sets 1466

Cont. Set	Nº Art.	€
1 - 10 x 0,5 mm	79644	167,06



Box-Pallet
1010

5 Sets 1456

Cont. Set	Nº Art.	€
1 - 13 x 0,5 mm	80671	353,40

Set 1407



37 Pcs

Cont. Ø	N° Art.	€
1 - 10 × 0,25 mm	26768	99,93

Set 1409



49 Pcs

Cont. Ø	N° Art.	€
1 - 13 × 0,25 mm	26802	182,01

Set 1405



50 Pcs

Cont. Ø	N° Art.	€
1 - 5,9 × 0,1 mm	26765	66,22

Set 1408



41 Pcs

Cont. Ø	N° Art.	€
6 - 10 × 0,1 mm	26771	171,28

Set 1406

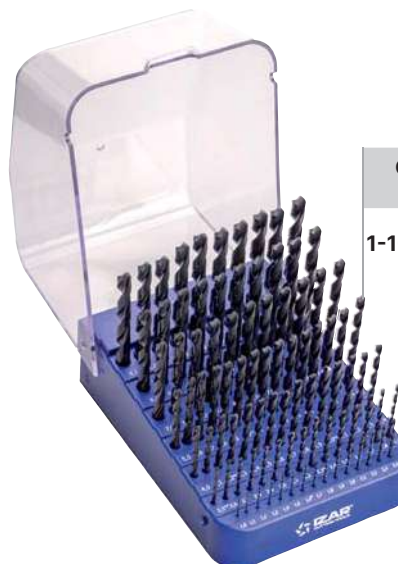

91 Pcs

Cont. Ø	N° Art.	€
1-10 × 0,10 mm	56685	230,98

New!

Set 1404

99 Pcs



Cont. Ø	N° Art.	€
1 - 10 × 0,10 mm *	48815	271,80

* +Previos Roscado / Before Threading
Pré-Tarudage (< 13 mm)





Set **1410** **NOVABOX**

Mida y ubique las brocas en un solo movimiento
Gauge and place the drills in one single movement
 Measurer et classer les forets en une seule course

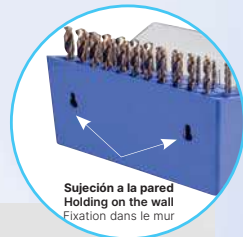

- Almacene y trabaje con este juego de 55 brocas para metal
- Manejo fácil para colocar las brocas en los huecos correspondientes
- Posibilidad de colgar en la pared gracias al colgador trasero
- Storage and management in a 55 metalworking drill set
- Easy use to put drills in suitable socket
- Possibility to hang on the wall
- Stockez et travaillez avec ce jeu de 55 forets
- Utilisation facile pour ranger les forets dans le trou correspondant
- Possibilité d'accrocher au mur grâce au crochet arrière



Agujeros para:

- Brocas desde 1 a 13 mm x 0,5 mm
- Incluye los siguientes diámetros previos al roscado:
 ø2,5 / 3,3 / 4,2 / 5,0 / 6,8 / 8,5 / 10,2 / 12,0 mm
 para las métricas de roscado
 M3 / M4 / M5 / M6 / M8 / M10 / M12 / M14

Holes for:

- Drill diameters from 1 to 13 mm x 0,5 mm
- Includes core hole sizes:
 ø2,5 / 3,3 / 4,2 / 5,0 / 6,8 / 8,5 / 10,2 / 12,0 mm for
 threading dimensions
 M3 / M4 / M5 / M6 / M8 / M10 / M12 / M14

Trous pour:

- Forets de 1 à 13 mm x 0,5 mm
- Inclut les diamètres suivantes pré-taraudage:
 ø2,5 / 3,3 / 4,2 / 5,0 / 6,8 / 8,5 / 10,2 / 12,0 mm
 pour les métriques de taraudage
 M3 / M4 / M5 / M6 / M8 / M10 / M12 / M14

New!



55 Pcs

Cont. Ø	Nº Art.	€
1 - 13 x 0,5 mm		
Ø1,0 - 4,0 mm: 3 pcs	19535	136,45
Ø4,2 - 8,0 mm: 2 pcs		
Ø8,50 - 13,0 mm: 1 pcs		

Sets **1470**

170 Pcs



Cont. Ø	Nº Art.	€
1-10 x 0,5 mm		
ø 1-8: 10 pcs/ø	19590	272,69
ø 8,5-10: 5 pcs/ø		

220 Pcs



Cont. Ø	Nº Art.	€
1-13 x 0,5 + 3,3 + 4,2 mm		
ø 1-8: 10 pcs/ø	56676	516,18
ø 8,5-13: 5 pcs/ø		



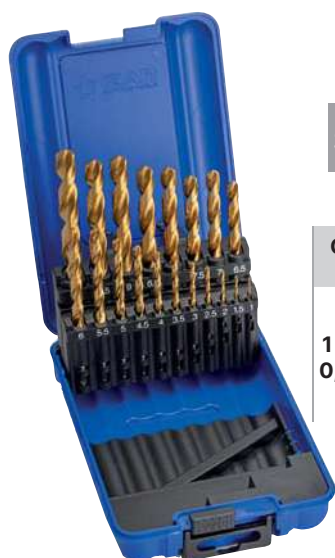

Set **1466**

19 Pcs

Cont. Ø	N° Art. TIN	€
1 - 10 x 0,5 mm	27132	75,42



Set **1456**

25 Pcs

Cont. Ø	N° Art. TIN	€
1 - 13 x 0,5 mm	27133	164,52

Set **1407**



37 Pcs

Cont. Ø	N° Art. TIN	€
1 - 10 x 0,25 mm	27134	179,66

Set **1409**



49 Pcs

Cont. Ø	N° Art. TIN	€
1 - 13 x 0,25 mm	27135	361,63

Set **1405**



50 Pcs

Cont. Ø	N° Art. TIN	€
1 - 5,9 x 0,1 mm	13154	120,14

Set **1408**



41 Pcs

Cont. Ø	N° Art. TIN	€
6 - 10 x 0,1 mm	13152	306,97



Ref. **1013**

BROCA MANGO CILÍNDRICO HSS SPEED POINT

Speed Point HSS Straight Shank Drill Bit
Foret queue cylindrique HSS Speed Point



SPEED POINT

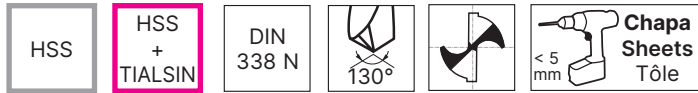

x 3,5

TIALSIN

Resistencia al desgaste
Wear Resistance
Haute résistance à l'usure

Aceros <850 N/mm ² Steel / Aciers	Fundición Cast Iron Fonte	Aluminio Aluminium
--	---------------------------------	-----------------------

D mm	L mm	I mm		Nº Art. HSS	€	Nº Art. TIALSIN	€
1,00	34	12	10	17673	1,17	37620	2,70
1,10	36	14	10	10650	1,30		
1,20	38	16	10	10656	1,30		
1,30	38	16	10	10662	1,14		
1,40	40	18	10	10663	1,14		
1,50	40	18	10	10666	0,88	37621	2,43
1,60	43	20	10	10669	1,08		
1,70	43	20	10	10670	1,08		
1,75	46	22	10	10671	0,98		
1,80	46	22	10	10672	0,97		
1,90	46	22	10	10674	0,97		
2,00	49	24	10	10675	0,82	37497	2,35
2,10	49	24	10	10677	0,88		
2,20	53	27	10	13596	0,88		
2,25	53	27	10	10679	0,79		
2,30	53	27	10	13608	1,03		
2,40	57	30	10	10683	1,03		
2,50	57	30	10	10684	0,84	37622	2,25
2,60	57	30	10	10685	1,04		
2,70	61	33	10	10686	1,04		
2,75	61	33	10	10687	0,89		
2,80	61	33	10	10690	1,04		
2,90	61	33	10	10692	1,04		
3,00	61	33	10	10693	0,75	37623	2,14
3,10	65	36	10	10695	0,89		
3,20	65	36	10	10696	0,89	32571	2,75
3,25	65	36	10	10698	0,89		
3,30	65	36	10	10699	0,89	37624	2,75
3,40	70	39	10	10701	1,13		
3,50	70	39	10	10702	0,88	37625	2,73
3,60	70	39	10	10704	1,17		
3,70	70	39	10	10705	1,17		
3,75	70	39	10	10708	1,03		
3,80	75	43	10	10710	1,25	39236	3,10
3,90	75	43	10	10719	1,25		
4,00	75	43	10	10770	0,98	32572	2,85
4,10	75	43	10	10774	1,09		
4,20	75	43	10	10776	1,09	36557	2,94

D mm	L mm	I mm		Nº Art. HSS	€	Nº Art. TIALSIN	€
4,25	75	43	10	10777	1,09		
4,30	80	47	10	10779	1,46		
4,40	80	47	10	10780	1,46		
4,50	80	47	10	10782	1,12	37627	2,99
4,60	80	47	10	10783	1,49		
4,70	80	47	10	10786	1,49	69082	3,34
4,75	80	47	10	10787	1,32		
4,80	86	52	10	10789	1,63	39240	3,47
4,90	86	52	10	10792	1,60		
5,00	86	52	10	10793	1,23	17442	3,07
5,10	86	52	10	10795	1,64		
5,20	86	52	10	10797	1,64	39242	3,50
5,25	86	52	10	10798	1,58		
5,30	86	52	10	10799	2,05	45421	3,90
5,40	93	57	10	10800	2,05		
5,50	93	57	10	10801	1,62	37628	3,46
5,60	93	57	10	10802	2,15		
5,70	93	57	10	10804	2,15	39244	4,00
5,75	93	57	10	10807	2,11		
5,80	93	57	10	10808	2,05		
5,90	93	57	10	10810	2,05		
6,00	93	57	10	10811	1,65	32677	3,52
6,10	101	63	10	10813	2,37		
6,20	101	63	10	10814	2,37	39246	7,55
6,25	101	63	10	10815	2,21		
6,30	101	63	10	10816	2,50		
6,40	101	63	10	10819	2,53		
6,50	101	63	10	10822	1,95	36558	7,14
6,60	101	63	10	11145	3,12		
6,70	101	63	10	11154	3,12	45424	8,28
6,75	109	69	10	11157	2,36	66924	7,54
6,80	109	69	10	11163	2,36	37629	7,54
6,90	109	69	10	11166	3,42	45725	8,56
7,00	109	69	10	11172	2,36	36559	7,54
7,10	109	69	10	11175	3,64		
7,20	109	69	10	13066	3,64		
7,25	109	69	10	11184	2,98		
7,30	109	69	10	11190	3,64		





Ref. **1013**

BROCA MANGO CILÍNDRICO HSS SPEED POINT

Speed Point HSS Straight Shank Drill Bit
Foret queue cylindrique HSS Speed Point



D mm	L mm	I mm		Nº Art. HSS	€	Nº Art. TIALSIN	€	D mm	L mm	I mm		Nº Art. HSS	€	Nº Art. TIALSIN	€
7,40	109	69	10	11202	3,64			10,90	142	94	5	17975	8,33		
7,50	109	69	10	11217	2,47	37630	7,65	11,00	142	94	5	13783	6,37	37635	17,99
7,60	117	75	10	14362	4,31			11,10	142	94	5	17978	8,50		
7,70	117	75	10	11226	4,31			11,20	142	94	5	66583	8,50		
7,75	117	75	10	11229	3,32			New! 11,25	142	94	5	53636	7,08		
7,80	117	75	10	11230	4,34			11,30	142	94	5	17980	8,50		
7,90	117	75	10	11251	4,34			11,40	142	94	5	17981	8,50		
8,00	117	75	10	11268	2,83	36560	8,00	11,50	142	94	5	17609	6,80	37636	18,43
8,10	117	75	5	11269	4,42			11,60	142	94	5	17982	8,34		
8,20	117	75	5	11287	4,42	64063	10,38	11,70	142	94	5	19657	8,34		
8,25	117	75	5	11290	3,32			11,80	142	94	5	17984	9,12		
8,30	117	75	5	11297	4,62			11,90	151	101	5	17987	9,12		
8,40	117	75	5	11302	4,62			12,00	151	101	5	17611	7,57	37637	19,20
8,50	117	75	5	11303	3,06	37498	9,04	12,10	151	101	5	63357	10,65		
8,60	125	81	5	11304	5,81			12,20	151	101	5	63358	10,65		
8,70	125	81	5	11305	5,81			New! 12,25	151	101	5	53639	9,21		
8,75	125	81	5	11306	4,45			12,30	151	101	5	22343	10,01		
8,80	125	81	5	11307	5,83			12,40	151	101	5	63360	10,01		
8,90	125	81	5	11308	5,83			12,50	151	101	5	17615	8,30	37638	22,97
9,00	125	81	5	11310	3,74	37631	9,70	12,60	151	101	5	63361	10,42		
9,10	125	81	5	14378	5,86	39252	11,79	12,70	151	101	5	17081	10,42		
9,20	125	81	5	14304	5,86	64064	11,78	New! 12,75	151	101	5	53645	9,07		
9,25	125	81	5	11313	4,51			12,80	151	101	5	63363	11,59		
9,30	125	81	5	14305	5,45			12,90	151	101	5	63364	11,59		
9,40	125	81	5	13007	5,45			13,00	151	101	5	16556	8,60	36556	23,28
9,50	125	81	5	11317	4,05	37632	10,02	New! 13,20	151	101	1	82665	11,63		
9,60	133	87	5	11318	6,99			13,50	160	108	1	22833	12,20	83459	26,70
9,70	133	87	5	13440	6,99			14,00	160	108	1	19224	13,08	64065	27,56
9,75	133	87	5	11321	5,10			14,50	169	114	1	24941	14,06		
9,80	133	87	5	11322	6,89			New! 15,00	169	114	1	19227	14,23	12770	28,29
9,90	133	87	5	11323	6,89			New! 15,25	178	120	1	25973	20,52		
10,00	133	87	5	11324	4,36	36147	10,32	15,50	178	120	1	51929	16,35		
10,10	133	87	5	22341	5,86			New! 16,00	178	120	1	22306	17,35	12771	28,58
10,20	133	87	5	17648	5,44	37633	17,12	16,50	184	125	1	51640	19,19		
New! 10,25	133	87	5	53630	5,98			New! 17,00	184	125	1	48580	19,19	12784	32,01
10,30	133	87	5	17506	6,84	37634	18,49	17,50	191	130	1	48582	22,06		
10,40	133	87	5	17966	6,84			New! 18,00	191	130	1	48583	23,35	12792	36,06
10,50	133	87	5	17613	5,44	38088	17,12	18,50	198	135	1	48585	25,94		
10,60	133	87	5	17969	7,50			New! 19,00	198	135	1	48586	25,94	12793	38,56
10,70	142	94	5	22342	7,50			19,50	205	140	1	48588	27,79		
New! 10,75	142	94	5	53633	6,92			New! 20,00	205	140	1	48589	31,67	12794	44,14
10,80	142	94	5	17972	8,33										



Expo - Ref. 1013



Cuartos / Quarters / Quarts

∅	1	1,5	2	2,5	3	3,25
Pcs	30	20	40	30	50	30
∅	3,5	4	4,25	4,5	5	
Pcs	30	50	30	30	50	
∅	5,5	6	6,5	7		
Pcs	40	50	20	20		
∅	7,5	8	8,5	9		
Pcs	20	40	20	20		
∅	9,5	10	11	12	13	
Pcs	5	20	5	10	5	

Nº Art. 57524: **1.168,20 €**

Previos Roscado / Before Threading / Pré-Taraudage

∅	1	1,5	2	2,5	3	3,3
Pcs	30	20	40	30	50	30
∅	3,5	4	4,2	4,5	5	
Pcs	30	50	30	30	50	
∅	5,5	6	6,5	6,8		
Pcs	40	50	20	10		
∅	7	7,5	8	8,5		
Pcs	20	20	40	20		
∅	9	9,5	10	10,2	11	12
Pcs	20	5	20	5	5	10
						13
						5

Nº Art. 57976: **1.219,00 €**

Línea 1 m - Ref. 1013



Cuartos / Quarters / Quarts

1,5 20	3	4	5	6 50	7 20	8 40	9 20	10 20	12 10	mm pcs
	2,5	3,5	4,5							
1 30	2	3,25	4,25	5,5 40	6,5 20	7,5 20	8,5 20	9,5 5	11 5	13 5
	2	3,3	4,2							

Nº Art. 71057: **1.168,20 €**

Previos Roscado / Before Threading / Pré-Taraudage

1,5 30	3	4	5	6 50	7 20	8 40	9,5 5	10,2 5	12 10	mm pcs
	2,5	3,5	4,5							
1 20	2	3,3	4,2	5,5 40	6,8 10	7,5 20	9 20	10 20	11 5	13 5
	2	3,3	4,2							

Nº Art. 71390: **1.219,00 €**





Expo - Ref. 1013



350 Pcs

∅	1	1,5	2	2,5	3	3,5	4	4,5
Pcs	10	10	20	20	40	20	40	20
∅	5		5,5		6		6,5	
Pcs	30		10		30		10	
∅	7,5		8		8,5		9	
Pcs	10		20		5		5	
∅	9,5		10		10,5		11	
Pcs	5		5		5		5	
∅	11,5		12		12,5		13	
Pcs	5		5		5		5	

N° Art. 55443: **681,35 €**



Ref. **1002**

BROCA MANGO CILÍNDRICO HSS SPEED POINT

Speed Point HSS Straight Shank Drill Bit
Foret queue cylindrique HSS Speed Point



SPEED POINT



Aceros
<850 N/mm²
Steel / Aciers

Fundición
Cast Iron
Fonte

Aluminio
Aluminium

D mm	L mm	I mm		Nº Art.	€
1,00	34	12	2	24778	2,72 *
1,50	40	18	2	16516	2,03 *
2,00	49	24	2	24779	1,94 *
2,50	57	30	2	24780	1,98 *
3,00	61	33	2	24781	1,76 *
3,25	65	36	2	24782	2,01 *
3,30	65	36	2	39913	2,01 *
3,50	70	39	2	24783	1,98 *
3,80	75	43	2	79610	2,81 *
4,00	75	43	2	24784	2,22 *
4,20	75	43	1	39914	1,24
4,25	75	43	1	24785	1,24
4,50	80	47	1	24786	1,28
4,80	86	52	1	79611	1,84
5,00	86	52	1	24787	1,38
5,20	86	52	1	73529	1,86
5,50	93	57	1	24788	1,83
5,80	93	57	1	79612	2,33
6,00	93	57	1	24789	1,88
6,50	101	63	1	24790	2,12
6,80	109	69	1	39915	2,58
7,00	109	69	1	24791	2,58
7,50	109	69	1	24792	2,71
8,00	117	75	1	24793	3,09
8,50	117	75	1	24794	3,34
9,00	125	81	1	24795	4,08
9,50	125	81	1	74946	4,43
10,00	133	87	1	24796	4,62
10,20	133	87	1	39916	5,78
10,50	133	87	1	74949	5,78
11,00	142	94	1	24797	6,73
11,50	142	94	1	74950	7,22
12,00	151	101	1	24798	8,01
12,50	151	101	1	79613	8,80
13,00	151	101	1	24799	9,14
14,00	160	108	1	79614	13,87

* € = 2 uds.





Línea 1 m - Ref. 1002



∅	1	1,5	2	2,5	3	3,25	3,5	4	4,25	4,5	5	5,5	6	6,5	7	7,5	8	9	10	
Packs	10	10	10	10	10	10	10	10	10	10	10	10	10	10	10	10	10	10	10	10

Ref. 4995 - Nº Art. 70947: **434,50 €**

Display 17 - Ref. 1002



∅	7,5	8	8,5	9	10	11	12	13		
Packs	8	8	5	5	3	3	3	3		
∅	4	4,25	4,5	5	5	5,5	6	6	6,5	7
Packs	5	10	10	5	5	10	5	5	10	8
∅	1	1,5	2	2,5	3	3	3,25	3,5	3,5	4
Packs	10	10	10	10	5	5	10	5	5	5

Ref. 4995 - Nº Art. 22492: **453,34 €**



Display 47 - Ref. 1002 + PREVIOS ROSCADO + Before Threading + Pré-Taraudage



∅	8	8,5	9	10	10,2	11	12	13		
Pcs	5	5	5	3	3	3	3	3		
∅	4,25	4,5	5	5	5,5	6	6,5	6,8	7	7,5
Pcs	10	5	5	5	5	10	5	5	5	5
∅	1	1,5	2	2,5	3	3,25	3,3	3,5	4	4,2
Pcs	10	10	10	5	10	10	5	10	10	5

Ref. 4995 - N° Art. 55620: 438,64 €

Display 59 - Refs. 1880 - 1640 - 1002

BROCAS SPEED POINT + PARED + MADERA

Speed Point + Masonry + Wood Drill Bits

Forets Speed Point + Maçonnerie + Bois



Ref. 1880	∅	3	4	5	6	7	8	9	10	12	14
	Pcs	10	10	10	10	10	10	5	5	5	5
Ref. 1640	∅	3	4	5	6	8	9	10	12	14	16
	Pcs	10	10	10	10	10	5	5	5	5	5
Ref. 1002	∅	2	3	3,5	4	4,5	5	6	7	8	10
	Pcs	10	10	10	10	10	10	5	5	5	3

Ref. 4995 - N° Art. 70099: 364,81 €

Sets - Ref. 1013



Set **1462**

6 Pcs

Cont. Ø	Nº Art.	€
2 - 3 - 4 - 5 - 6 - 8 mm	25365	9,10



New!

Set **1459**

29 Pcs

Cont. Ø	Nº Art.	€
1 - 13 x 0,5 mm *	15088	92,76

* + Previos Roscado / Before Threading
Pré-Taroudage (3,3 - 4,2 - 6,8 - 10,2 mm)

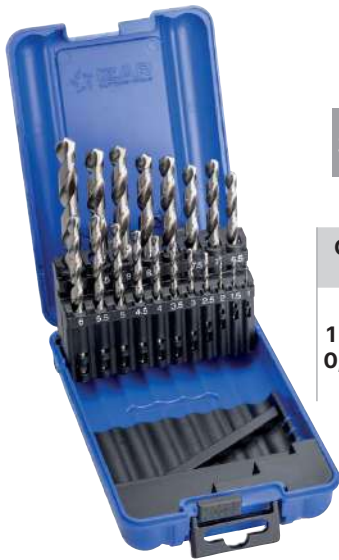

Set **1466**

19 Pcs

Cont. Ø	Nº Art.	€
1 - 10 x 0,5 mm	18808	39,12



Set **1456**

25 Pcs

Cont. Ø	Nº Art.	€
1 - 13 x 0,5 mm	18807	82,95



Box-Pallet
1013

5 Sets 1466

Cont. Set	Nº Art.	€
1 - 10 x 0,5 mm	80659	185,82



Box-Pallet
1013

5 Sets 1456

Cont. Set	Nº Art.	€
1 - 13 x 0,5 mm	80675	394,01





Set **1406**
91 Pcs

Cont. Ø	Nº Art.	€
1-10 x 0,10 mm	60624	255,64

New! Set **1404**
99 Pcs

Cont. Ø	Nº Art.	€
1 - 10 x 0,10 mm *	48818	303,37

* + Previos Roscado / Before Threading
Pré-Taroudage (< 13 mm)

Set **1410** **NOVABOX**
New!

55 Pcs

Cont. Ø	Nº Art.	€
1 - 13 x 0,5 mm Ø1,0 - 4,0 mm: 3 pcs Ø4,2 - 8,0 mm: 2 pcs Ø8,50 - 13,0 mm: 1 pcs	19536	148,37

Sets **1470**
170 Pcs

Cont. Ø	Nº Art.	€
1-10 x 0,5 mm Ø 1-8: 10 pcs/Ø Ø 8,5-10: 5 pcs/Ø	56677	304,09

220 Pcs

Cont. Ø	Nº Art.	€
1-13 x 0,5 + 3,3 + 4,2 mm Ø 1-8: 10 pcs/Ø Ø 8,5-13: 5 pcs/Ø	56679	572,68





Sets - Ref. 1013



TIALSIN Set **1466**

19 Pcs

Cont. Ø	N° Art. TIALSIN	€
1 - 10 x 0,5 mm	38833	102,26

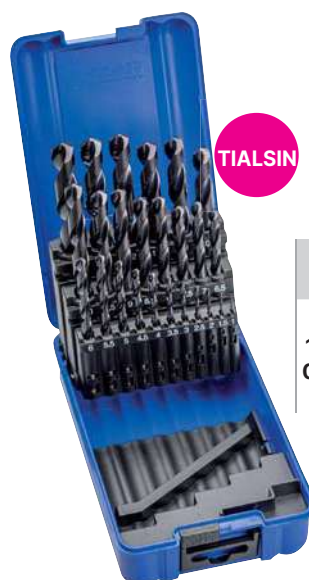

TIALSIN Set **1456**

25 Pcs

Cont. Ø	N° Art. TIALSIN	€
1 - 13 x 0,5 mm	38832	222,00



Ref. **1007**

BROCA MANGO REBAJADO HSS

HSS Reduced Shank Drill Bit
Foret queue reduite HSS



Aceros
<850 N/mm²
Steel / Aciers

Fundición
Cast Iron
Fonte

Aluminio
Aluminium

D mm	d mm	L mm	l mm		Nº Art.	€
10,50	10,00	133	87	1	15976	7,23
11,00	10,00	142	94	1	15977	8,18
11,50	10,00	142	94	1	15978	8,65
12,00	10,00	151	101	1	15979	9,45
12,50	10,00	151	101	1	15980	10,24
13,00	10,00	151	101	1	15981	10,53
13,50	12,70	160	108	1	15982	14,22
14,00	12,70	160	108	1	15984	15,10
14,50	12,70	169	114	1	15985	16,13
15,00	12,70	169	114	1	15987	16,29
15,50	12,70	178	120	1	15988	18,79
16,00	12,70	178	120	1	15989	19,48
16,50	12,70	184	125	1	15990	21,85
17,00	12,70	184	125	1	15991	21,85
17,50	12,70	191	130	1	15992	24,86

D mm	d mm	L mm	l mm		Nº Art.	€
18,00	12,70	191	130	1	15993	26,18
18,50	12,70	198	135	1	15994	28,89
19,00	12,70	198	135	1	15995	28,89
19,50	12,70	205	140	1	15996	31,48
20,00	12,70	205	140	1	15997	36,26
20,50	12,70	205	145	1	66932	38,36
21,00	12,70	205	145	1	17071	38,36
21,50	12,70	210	150	1	66933	42,29
22,00	12,70	210	150	1	17072	42,29
22,50	12,70	210	150	1	66934	46,27
23,00	12,70	210	150	1	36364	46,27
23,50	12,70	220	160	1	66935	51,07
24,00	12,70	220	160	1	36365	51,07
24,50	12,70	220	160	1	66936	55,66
25,00	12,70	220	160	1	36366	55,66



Línea 1 m - Ref. 1007



∅	12	12,5	13	13,5	14	15	15,5	16	16,5	17	17,5	18	18,5	19	19,5	20
Pcs	2	2	2	2	2	2	2	2	2	2	2	2	2	2	2	2

Ref. 4995 - Nº Art. 70951: 668,72 €

Display 18 - Ref. 1007



∅	17	17,5	18	18	18,5	19	19,5	20
Pcs	2	2	1	1	1	1	1	1
∅	14	14	14,5	15	15,5	16	16	16,5
Pcs	2	1	2	2	2	1	1	2
∅	10,5	11	11,5	12	12	12,5	13	13,5
Pcs	2	2	2	2	1	2	2	2

Ref. 4995 - Nº Art. 22352: 648,13 €



Ref. **1012**

BROCA MANGO CILÍNDRICO HSS

HSS Straight Shank Drill Bit
Foret queue cylindrique HSS



HSS

DIN
338 H



Cobre
Copper
Cuivre

Bronce
Bronze

Latón
Brass
Laiton

D mm	L mm	I mm		Nº Art.	€	D mm	L mm	I mm		Nº Art.	€
1,00	34	12	10	10586	2,80	7,50	109	69	10	10625	7,14
1,25	38	16	10	27590	3,15	7,75	117	75	10	19022	15,31
1,50	40	18	10	10589	2,79	8,00	117	75	10	10628	7,61
2,00	49	24	10	10592	2,49	8,25	117	75	10	19031	14,28
2,25	53	27	10	18908	2,65	8,50	117	75	10	10631	8,82
2,50	57	30	10	10595	2,29	9,00	125	81	10	10634	9,29
2,75	61	33	10	18917	3,12	9,50	125	81	10	10637	10,88
3,00	61	33	10	10598	2,54	9,75	133	87	10	19040	24,36
3,25	65	36	10	18932	3,12	10,00	133	87	10	10640	11,34
3,50	70	39	10	10601	2,72	10,50	133	87	5	10643	13,61
*3,75	70	39	10	18941	4,05	11,00	142	94	5	10646	15,17
4,00	75	43	10	10604	2,97	11,50	142	94	5	10649	18,35
4,25	75	43	10	18953	4,42	12,00	151	101	5	10652	19,78
4,50	80	47	10	10607	3,63	12,50	151	101	5	10655	22,43
4,75	80	47	10	18968	5,76	13,00	151	101	5	10658	24,04
5,00	86	52	10	10610	3,93	14,00	160	108	1	18863	36,69
5,20	86	52	10	18974	6,03	14,50	169	114	1	46846	52,67
5,25	86	52	10	18977	5,94	15,00	169	114	1	54158	54,25
5,50	93	57	10	10613	4,79	16,00	178	120	1	46847	57,65
*5,75	93	57	10	18980	7,27	16,50	184	125	1	46848	59,29
6,00	93	57	10	10616	5,17	17,00	184	125	1	46849	61,10
6,25	101	63	10	18986	7,27	18,00	191	130	1	54159	64,87
6,50	101	63	10	10619	5,76	18,50	198	135	1	46851	66,58
6,75	109	69	10	18998	8,76	19,00	198	135	1	46852	68,67
7,00	109	69	10	10622	6,07	20,00	205	140	1	46850	72,49
7,25	109	69	10	19013	11,58						



* Diam. hasta fin de existencias / while stock lasts / jusqu'à la fin de stock



Ref. **1025**

BROCA MANGO CILÍNDRICO CORTE IZQUIERDA

Left Hand Straight Shank Drill Bit

Foret queue cylindrique coupe à gauche



D mm	L mm	I mm	3D	Nº Art.	€
1,00	34	12	10	10554	3,63
1,50	40	18	10	10560	3,63
2,00	49	24	10	10562	3,30
2,50	57	30	10	10564	3,30
3,00	61	33	10	10569	2,50
3,50	70	39	10	11121	2,93
4,00	75	43	10	11566	3,30
4,50	80	47	10	11811	3,75
5,00	86	52	10	11817	4,05
5,50	93	57	10	11820	5,39
6,00	93	57	10	12001	5,54

D mm	L mm	I mm	3D	Nº Art.	€
6,50	101	63	10	12330	6,47
7,00	109	69	10	12336	7,85
7,50	109	69	10	12339	8,25
8,00	117	75	10	12345	9,45
8,50	117	75	10	12348	10,18
9,00	125	81	10	12399	12,39
9,50	125	81	10	12408	13,52
10,00	133	87	10	12417	14,55
11,00	142	94	5	70015	23,44
12,00	151	101	5	70016	27,86
13,00	151	101	5	70017	35,14



Sets - Ref. 1025



Set **1462**

6 Pcs

Cont. Ø	Nº Art.	€
2 - 3 - 4 - 5 - 6 - 8 mm	67380	28,98



Set **1466**

19 Pcs

Cont. Ø	Nº Art.	€
1 - 10 x 0,5 mm	66659	126,34



Ref. **1660**

BROCA MANGO CILÍNDRICO HSS DOBLE

Double HSS Straight Shank Drill Bit
Foret queue cylindrique HSS double



Aceros
<850 N/mm²
Steel / Aciers

D mm	L mm	I mm		Nº Art.	€	D mm	L mm	I mm		Nº Art.	€
2,00	38	9	10	16028	1,92	4,25	58	16	10	16085	2,05
2,20	40	9	10	27607	1,76	4,50	58	16	10	16088	2,11
New! 2,25	43	10	10	16031	2,01	4,75	62	18	10	16094	3,42
2,30	43	10	10	25604	2,27	4,80	62	18	10	16097	2,34
New! 2,40	43	10	10	25607	2,27	4,90	62	18	10	16100	2,34
2,50	43	10	10	16034	1,90	5,00	62	18	10	16103	2,41
New! 2,75	46	13	10	16037	1,78	5,10	66	19	10	16106	3,30
2,80	46	13	10	16040	1,78	5,20	66	19	10	16109	3,30
2,90	46	13	10	16043	1,78	5,25	66	19	10	16112	3,42
3,00	46	13	10	16046	1,65	5,50	66	19	10	16115	2,93
3,10	52	14	10	16049	1,65	5,70	66	19	10	25634	3,87
3,20	52	14	10	16052	1,65	5,75	66	19	10	16121	4,04
3,25	52	14	10	16055	1,65	6,00	66	19	10	16127	3,28
3,30	52	14	10	16058	1,65	New! 6,10	70	21	10	25640	4,42
3,40	52	14	10	16061	1,84	New! 6,20	70	21	10	25643	4,42
3,50	52	14	10	16064	1,84	6,50	70	21	10	16133	3,62
3,70	55	15	10	16067	2,05	7,00	74	24	10	16136	4,32
3,75	55	15	10	16070	2,11	7,40	74	24	10	25664	5,93
3,80	55	15	10	16073	2,05	7,50	74	24	10	16139	4,41
4,00	55	15	10	16076	1,90	8,00	79	25	10	16142	5,27
4,10	58	16	10	16079	2,05	9,00	84	25	10	16148	7,06
4,20	58	16	10	16082	2,05	10,00	89	27	10	16154	7,59



Ref. **1052** New!

BROCA MANGO CILÍNDRICO HSS ZIRKONIO. SERIE EXTRA CORTA

HSS Zirkonio Straight Shank Drill Bit. Stub Series

Foret queue cylindrique HSS Zirkonio. Série extra-courte

Ref. **1052**

BROCA MANGO CILÍNDRICO HSS ZIRKONIO. SERIE EXTRA CORTA

HSS Zirkonio Straight Shank Drill Bit. Stub Series

Foret queue cylindrique HSS Zirkonio. Série extra-courte

New!



ZIRKONIO

HSS	Zirkonio	DIN 1897 N	135°	DIN 1412 C ≥ 2 mm				Rectificado Ground Taillé meulé	ToL. D h8
-----	----------	------------	------	----------------------	--	--	--	---------------------------------------	--------------

Aceros <850 N/mm ² Steel / Aciers	Fundición Cast Iron Fonte	Aluminio Aluminium
---	--	------------------------------



D mm	L mm	I mm		N° Art.	€	D mm	L mm	I mm		N° Art.	€	D mm	L mm	I mm		N° Art.	€
1,00	26	6	10	44999	1,65	5,00	62	26	10	25064	2,15	9,10	84	40	10	45386	7,33
1,10	28	7	10	48470	2,00	5,10	62	26	10	45212	2,50	9,20	84	40	10	48563	7,33
1,20	30	8	10	48476	2,00	5,20	62	26	10	25066	2,50	9,25	84	40	10	45545	6,26
1,25	30	8	10	45458	1,65	5,25	62	26	10	45512	2,25	9,30	84	40	10	48566	7,73
1,30	30	8	10	48479	2,15	5,30	62	26	10	45218	2,11	9,40	84	40	10	48569	7,73
1,40	32	9	10	48482	2,15	5,40	66	28	10	45221	2,11	9,50	84	40	10	25132	6,39
1,50	32	9	10	45002	1,64	5,50	66	28	10	25072	2,45	9,60	89	43	10	48572	9,46
1,60	34	10	10	45005	2,02	5,60	66	28	10	45224	2,91	9,70	89	43	10	48575	9,46
1,70	34	10	10	48488	2,21	5,70	66	28	10	45227	2,91	9,75	89	43	10	45548	6,92
1,75	36	11	10	45464	1,92	5,75	66	28	10	45515	2,58	9,80	89	43	10	48578	8,06
1,80	36	11	10	45026	2,13	5,80	66	28	10	45230	3,01	9,90	89	43	10	48581	8,06
1,90	36	11	10	45028	2,13	5,90	66	28	10	45341	3,01	10,00	89	43	10	25135	7,18
2,00	38	12	10	24853	1,74	6,00	66	28	10	25075	2,79	10,10	89	43	1	48584	11,24
2,10	40	13	10	45065	1,99	6,10	70	31	10	45353	3,36	10,20	89	43	1	25137	9,91
2,20	40	13	10	45068	1,99	6,20	70	31	10	45356	3,36	10,25	89	43	1	45551	9,91
2,25	40	13	10	48785	1,77	6,25	70	31	10	45524	2,99	10,30	89	43	1	48587	10,50
2,30	40	13	10	45071	1,84	6,30	70	31	10	45359	3,23	10,50	89	43	1	25138	9,53
2,40	43	14	10	45074	1,84	6,40	70	31	10	45362	3,20	10,80	95	47	1	48590	11,70
2,50	43	14	10	24898	1,37	6,50	70	31	10	25078	3,37	11,00	95	47	1	25139	10,21
2,60	43	14	10	24899	1,71	6,60	70	31	10	45365	3,69	11,10	95	47	1	48788	13,53
2,70	46	16	10	45078	1,71	6,70	70	31	10	45368	3,69	11,20	95	47	1	48593	13,53
2,75	46	16	10	45470	1,48	6,75	74	34	10	45527	3,07	11,25	95	47	1	45557	13,14
2,80	46	16	10	45080	1,72	6,80	74	34	10	25081	3,80	11,50	95	47	1	45389	12,48
2,90	46	16	10	45083	1,72	6,90	74	34	10	48494	3,16	11,80	95	47	1	48602	14,93
3,00	46	16	10	24900	1,49	7,00	74	34	10	25085	3,57	12,00	102	51	1	25141	12,99
3,10	49	18	10	45128	1,73	7,10	74	34	10	48497	4,59	12,10	102	51	1	48605	16,31
3,20	49	18	10	24901	1,73	7,20	74	34	10	45374	4,59	12,20	102	51	1	48608	16,31
3,25	49	18	10	24902	1,73	7,25	74	34	10	45530	3,94	12,25	102	51	1	45560	15,27
3,30	49	18	10	24903	1,73	7,30	74	34	10	48503	4,49	12,50	102	51	1	25142	16,03
3,40	52	20	10	45134	1,69	7,40	74	34	10	45377	4,49	12,70	102	51	1	45563	16,68
3,50	52	20	10	24905	1,71	7,50	74	34	10	25091	4,02	13,00	102	51	1	25143	16,86
3,60	52	20	10	45153	2,12	7,60	79	37	10	48506	5,33	13,50	107	54	1	45392	21,78
3,70	52	20	10	45154	2,12	7,70	79	37	10	48533	5,33	14,00	107	54	1	45398	23,44
3,75	52	20	10	45473	1,84	7,75	79	37	10	45536	4,46	14,50	111	56	1	45419	26,01
3,80	55	22	10	45163	2,05	7,80	79	37	10	45380	5,30	15,00	111	56	1	45422	28,12
3,90	55	22	10	45165	2,05	7,90	79	37	10	48539	5,30	15,25	115	58	1	48800	38,21
4,00	55	22	10	24906	1,83	8,00	79	37	10	25102	4,58	15,50	115	58	1	45425	31,33
4,10	55	22	10	24913	2,00	8,10	79	37	10	48542	5,49	15,75	115	58	1	48791	38,21
4,20	55	22	10	24943	2,00	8,20	79	37	10	48548	5,49	16,00	115	58	1	45428	34,05
4,25	55	22	10	45491	2,00	8,25	79	37	10	45539	4,69	16,50	119	60	1	45572	40,07
4,30	58	24	10	25027	1,93	8,30	79	37	10	48551	5,29	17,00	119	60	1	45575	40,07
4,40	58	24	10	45197	1,93	8,40	79	37	10	48554	5,29	17,50	123	62	1	45577	44,65
4,50	58	24	10	25028	2,03	8,50	79	37	10	25106	5,11	18,00	123	62	1	45578	44,65
4,60	58	24	10	45200	2,31	8,70	84	40	10	45383	5,85	18,50	127	64	1	45585	49,70
4,70	58	24	10	45203	2,31	8,75	84	40	10	45542	5,20	19,00	127	64	1	45588	49,70
4,75	58	24	10	45500	2,03	8,80	84	40	10	48557	5,83	19,50	131	66	1	45597	59,61
4,80	62	26	10	45206	2,18	8,90	84	40	10	48560	5,83	20,00	131	66	1	45614	59,61
4,90	62	26	10	25061	2,21	9,00	84	40	10	25130	6,04						



Ref. **1050**

BROCA MANGO CILÍNDRICO HSS EXTRA CORTA

HSS Straight Shank Stub Drill Bit
Foret queue cylindrique HSS extra-courte



HSS

DIN 1897 N



Serie Extra Corta
Stub Series
Série extra-courte

Aceros <850 N/mm²
Steel / Aciers

Fundición
Cast Iron
Fonte

Aluminio
Aluminium

	D mm	L mm	I mm	Nº Art.	€
	1,00	26	6	10 20606	1,22
New!	1,10	28	7	10 48338	1,42
New!	1,20	30	8	10 48341	1,42
	1,25	30	8	10 20615	1,06
New!	1,30	30	8	10 48344	1,42
New!	1,40	32	9	10 48347	1,42
	1,50	32	9	10 12302	1,06
	1,60	34	10	10 12305	1,23
New!	1,70	34	10	10 48350	1,42
	1,75	36	11	10 12311	1,22
	1,80	36	11	10 12314	1,23
	1,90	36	11	10 12317	1,23
	2,00	38	12	10 12320	1,05
	2,10	40	13	10 12323	1,10
	2,20	40	13	10 12326	1,10
	2,25	40	13	10 12329	0,95
	2,30	40	13	10 12332	1,10
	2,40	43	14	10 12335	1,10
	2,50	43	14	10 12338	0,84
	2,60	43	14	10 12341	1,03
	2,70	46	16	10 12344	1,03
	2,75	46	16	10 12347	0,91
	2,80	46	16	10 12350	1,04
	2,90	46	16	10 12353	1,04
	3,00	46	16	10 12356	0,91
	3,10	49	18	10 12359	0,97
	3,20	49	18	10 12362	0,97
	3,25	49	18	10 12365	0,97
	3,30	49	18	10 12368	0,97
	3,40	52	20	10 12371	1,10
	3,50	52	20	10 12374	0,97
	3,60	52	20	10 12377	1,23
	3,70	52	20	10 12380	1,23
	3,75	52	20	10 12383	1,07
	3,80	55	22	10 12386	1,23
	3,90	55	22	10 12389	1,23
	4,00	55	22	10 12392	1,07
	4,10	55	22	10 12395	1,27
	4,20	55	22	10 12398	1,27
	4,25	55	22	10 12401	1,27
	4,30	58	24	10 12404	1,44
	4,40	58	24	10 12407	1,44
	4,50	58	24	10 12410	1,27
	4,60	58	24	10 20636	1,64
	4,70	58	24	10 20639	1,64
	4,75	58	24	10 12413	1,41
	4,80	62	26	10 12416	1,64
	4,90	62	26	10 12419	1,64
	5,00	62	26	10 12422	1,41
	5,10	62	26	10 12425	1,79
	5,20	62	26	10 12428	1,79
	5,25	62	26	10 12431	1,57
	5,30	62	26	10 12434	1,80
	5,40	66	28	10 12437	1,80
	5,50	66	28	10 12440	1,57
	5,60	66	28	10 12443	2,07
	5,70	66	28	10 12446	2,07
	5,75	66	28	10 12449	1,78

	D mm	L mm	I mm	Nº Art.	€
	5,80	66	28	10 12452	2,07
	5,90	66	28	10 12455	2,07
	6,00	66	28	10 12458	1,78
	6,10	70	31	10 20651	2,42
	6,20	70	31	10 20654	2,42
	6,25	70	31	10 12461	2,12
	6,30	70	31	10 20657	2,42
	6,40	70	31	10 20663	2,42
	6,50	70	31	10 12464	2,12
	6,60	70	31	10 20666	2,84
	6,70	70	31	10 20669	2,84
	6,75	74	34	10 12467	2,44
	6,80	74	34	10 20672	2,44
New!	6,90	74	34	10 48353	2,60
	7,00	74	34	10 12470	2,44
New!	7,10	74	34	10 48362	3,16
	7,20	74	34	10 20681	3,16
	7,25	74	34	10 27317	2,78
New!	7,30	74	34	10 48365	3,06
	7,40	74	34	10 30591	3,06
	7,50	74	34	10 12473	2,78
New!	7,60	79	37	10 48368	3,51
New!	7,70	79	37	10 48383	3,51
	7,75	79	37	10 12476	3,06
	7,80	79	37	10 20696	3,51
New!	7,90	79	37	10 48386	3,51
	8,00	79	37	10 12479	3,06
New!	8,10	79	37	10 48389	4,08
New!	8,20	79	37	10 48392	4,08
	8,25	79	37	10 12482	3,64
New!	8,30	79	37	10 48395	4,08
New!	8,40	79	37	10 48398	4,08
	8,50	79	37	10 12485	3,64
New!	8,70	84	40	10 20720	4,22
	8,75	84	40	10 12488	3,99
New!	8,80	84	40	10 48401	4,22
New!	8,90	84	40	10 48404	4,22
	9,00	84	40	10 12491	3,99
	9,10	84	40	10 30592	4,96
New!	9,20	84	40	10 48407	4,96
	9,25	84	40	10 12494	4,45
New!	9,30	84	40	10 48410	4,96
New!	9,40	84	40	10 48413	4,96
	9,50	84	40	10 12497	4,45
New!	9,60	89	43	10 48416	6,80
New!	9,70	89	43	10 48419	6,80
	9,75	89	43	10 27334	4,96
New!	9,80	89	43	10 48422	5,25
New!	9,90	89	43	10 48335	5,25
	10,00	89	43	10 12500	4,96
New!	10,10	89	43	1 48428	6,02
New!	10,15	89	43	1 16195	6,02
	10,20	89	43	1 20756	5,62
	10,25	89	43	1 12503	6,23
New!	10,30	89	43	1 48431	6,60
	10,50	89	43	1 12506	5,62
New!	10,80	95	47	1 48434	7,11
	11,00	95	47	1 12512	6,23

	D mm	L mm	I mm	Nº Art.	€
	11,10	95	47	1 30593	7,33
New!	11,20	95	47	1 48437	7,33
	11,25	95	47	1 12515	6,93
	11,50	95	47	1 12518	6,93
New!	11,80	95	47	1 48449	8,85
New!	12,00	102	51	1 12527	7,33
New!	12,10	102	51	1 48452	9,32
New!	12,20	102	51	1 48455	9,32
	12,25	102	51	1 12530	8,25
	12,50	102	51	1 12533	8,25
	12,70	102	51	1 20813	8,68
	13,00	102	51	1 12539	9,01
	13,50	107	54	1 12545	11,45
	14,00	107	54	1 12551	12,37
	14,50	111	56	1 12554	14,13
	15,00	111	56	1 12557	16,15
New!	15,25	115	58	1 48797	23,74
	15,50	115	58	1 12560	19,46
New!	15,75	115	58	1 20834	23,74
	16,00	115	58	1 12563	19,46
	16,50	119	60	1 12566	22,90
	17,00	119	60	1 12569	22,90
	17,50	123	62	1 12572	25,51
	18,00	123	62	1 12575	25,51
	18,50	127	64	1 12578	28,40
	19,00	127	64	1 12581	28,40
	19,50	131	66	1 12584	34,06
	20,00	131	66	1 12587	34,06

Set **1476**



19 Pcs

Cont. Ø	Nº Art.	€
1 - 10 x 0,5 mm	11935	62,95



Ref. **1030**

BROCA MANGO CILÍNDRICO HSS LARGA

HSS Straight Shank Long Drill Bit
Foret queue cylindrique HSS longue



HSS	DIN 340 N			Serie Larga Long Series Série longue
-----	-----------	--	--	--

Aceros <850 N/mm ² Steel / Aciers	Fundición Cast Iron Fonte	Aluminio Aluminium
--	---------------------------------	-----------------------

D mm	L mm	I mm		Nº Art.	€	D mm	L mm	I mm		Nº Art.	€
0,50	32	12	10	26656	5,77	4,20	119	78	10	11687	3,36
0,60	35	15	10	26658	4,69	4,25	119	78	10	11690	3,36
0,70	42	21	10	19467	4,69	4,30	126	82	10	11693	4,34
0,80	46	25	10	24592	4,69	4,40	126	82	10	11696	4,34
0,90	51	29	10	26659	4,69	4,50	126	82	10	11699	3,06
1,00	56	33	10	11573	4,74	4,60	126	82	10	11702	4,34
1,10	60	37	10	11576	4,60	4,70	126	82	10	19955	4,34
1,20	65	41	10	11579	4,60	4,75	126	82	10	11705	4,52
1,25	65	41	10	11582	4,75	4,80	132	87	10	11708	5,02
1,30	65	41	10	11585	4,60	4,90	132	87	10	11711	5,02
1,40	70	45	10	11588	4,60	5,00	132	87	10	11714	3,29
New! 1,45	70	45	10	31704	4,60	5,10	132	87	10	11717	5,02
1,50	70	45	10	11591	3,42	5,20	132	87	10	11720	5,02
1,60	76	50	10	11594	4,60	5,25	132	87	10	11723	5,20
1,70	76	50	10	11597	4,60	5,30	132	87	10	11726	5,45
1,75	80	53	10	11600	3,81	5,40	139	91	10	11729	5,45
1,80	80	53	10	11603	3,66	5,50	139	91	10	11732	4,33
1,90	80	53	10	11606	3,66	5,60	139	91	10	11735	5,45
2,00	85	56	10	11609	2,42	5,70	139	91	10	11738	5,45
2,10	85	56	10	11612	3,34	5,75	139	91	10	11741	5,67
2,20	90	59	10	11615	3,34	5,80	139	91	10	11744	6,00
2,25	90	59	10	11618	2,67	5,90	139	91	10	11747	6,00
2,30	90	59	10	11621	3,21	6,00	139	91	10	11750	4,02
2,40	95	62	10	11624	3,21	6,10	148	97	10	11753	6,00
2,50	95	62	10	11627	2,42	6,20	148	97	10	11756	6,00
2,60	95	62	10	11630	3,21	6,25	148	97	10	11759	6,22
2,70	100	66	10	11633	3,21	6,30	148	97	10	11762	6,07
2,75	100	66	10	11636	3,34	6,40	148	97	10	11765	6,07
2,80	100	66	10	11639	3,21	6,50	148	97	10	11768	5,14
2,90	100	66	10	11642	3,21	6,60	148	97	10	11771	6,07
3,00	100	66	10	11645	2,26	6,70	148	97	10	11774	6,07
3,10	106	69	10	11648	2,50	6,75	156	102	10	11777	6,29
3,20	106	69	10	11651	2,50	6,80	156	102	10	11780	6,29
3,25	106	69	10	11654	2,50	6,90	156	102	10	11783	6,44
3,30	106	69	10	11657	2,50	7,00	156	102	10	11786	5,99
3,40	112	73	10	11660	3,21	7,10	156	102	10	11789	6,44
3,50	112	73	10	11663	2,37	7,20	156	102	10	11792	6,44
3,60	112	73	10	11666	3,21	7,25	156	102	10	11795	6,70
3,70	112	73	10	11669	3,21	7,30	156	102	10	11798	6,57
3,75	112	73	10	11672	3,34	7,40	156	102	10	11801	6,57
3,80	119	78	10	11675	4,01	7,50	156	102	10	11804	6,38
3,90	119	78	10	11678	4,01	7,60	165	109	10	11807	6,57
4,00	119	78	10	11681	2,56	7,70	165	109	10	11810	6,57
4,10	119	78	10	11684	3,36	7,75	165	109	10	11813	6,83





Ref. **1030**

BROCA MANGO CILÍNDRICO HSS LARGA

HSS Straight Shank Long Drill Bit
Foret queue cylindrique HSS longue



D mm	L mm	I mm		Nº Art.	€	D mm	L mm	I mm		Nº Art.	€
7,80	165	109	10	11816	7,35	11,80	195	128	1	11960	18,88
7,90	165	109	10	11819	7,35	11,90	205	134	1	11963	18,88
8,00	165	109	10	11822	7,11	12,00	205	134	1	11966	16,08
8,10	165	109	5	11825	7,35	12,20	205	134	1	11972	18,19
8,20	165	109	5	11828	7,35	12,25	205	134	1	11975	18,24
8,25	165	109	5	11831	7,63	12,30	205	134	1	11978	21,50
8,30	165	109	5	11834	11,30	12,50	205	134	1	11984	16,93
8,40	165	109	5	11837	11,30	12,75	205	134	1	11993	22,34
8,50	165	109	5	11840	7,90	13,00	205	134	1	12002	19,22
8,60	175	115	5	11843	11,30	13,25	214	140	1	12005	22,34
8,70	175	115	5	11846	11,30	13,50	214	140	1	12008	21,45
8,75	175	115	5	11849	11,76	13,75	214	140	1	12011	22,40
8,80	175	115	5	11852	11,55	14,00	214	140	1	12014	23,15
8,90	175	115	5	11855	11,55	14,25	220	144	1	12017	41,70
9,00	175	115	5	11858	8,59	14,50	220	144	1	12020	27,12
9,10	175	115	5	11861	11,55	14,75	220	144	1	12023	41,70
9,20	175	115	5	11864	11,55	15,00	220	144	1	12026	26,22
9,25	175	115	5	11867	12,01	15,25	227	149	1	12029	47,10
9,30	175	115	5	11870	12,44	15,50	227	149	1	12032	38,93
9,40	175	115	5	11873	12,44	15,75	227	149	1	12035	47,10
9,50	175	115	5	11876	8,70	16,00	227	149	1	12038	30,53
9,60	184	121	5	11879	12,44	16,25	235	154	1	12041	51,98
9,70	184	121	5	11882	12,44	16,50	235	154	1	12044	36,11
9,75	184	121	5	11885	12,91	16,75	235	154	1	12047	51,98
9,80	184	121	5	11888	12,44	17,00	235	154	1	12050	36,28
9,90	184	121	5	11891	12,44	17,25	241	158	1	12053	59,76
10,00	184	121	5	11894	9,40	17,50	241	158	1	12056	53,63
10,20	184	121	1	11900	12,70	17,75	241	158	1	12059	69,69
10,25	184	121	1	11903	11,76	18,00	241	158	1	12062	37,83
10,50	184	121	1	11912	12,70	18,25	247	162	1	12065	82,09
10,75	195	128	1	11921	12,91	18,50	247	162	1	12068	58,59
10,80	195	128	1	11924	16,15	18,75	247	162	1	12071	81,39
11,00	195	128	1	11930	14,12	19,00	247	162	1	12074	47,41
11,10	195	128	1	30588	18,88	19,25	254	166	1	12077	86,17
11,25	195	128	1	11939	16,78	19,50	254	166	1	12080	91,21
11,50	195	128	1	11948	14,39	19,75	254	166	1	12083	103,00
11,75	195	128	1	11957	18,88	20,00	254	166	1	12086	53,21





Ref. **1003**

BROCA MANGO CILÍNDRICO HSS LARGA

HSS Straight Shank Long Drill Bit
Foret queue cylindrique HSS longue



HSS	DIN 340 N	 118°		Serie Larga Long Series Série longue
------------	--------------	----------	--	---

Aceros <850 N/mm ² Steel / Aciers	Fundición Cast Iron Fonte	Aluminio Aluminium
---	--	------------------------------

D mm	L mm	I mm		Nº Art.	€
2,00	85	56	1	10572	2,84
2,50	95	62	1	10573	2,84
3,00	100	66	1	10581	2,65
3,25	106	69	1	10582	2,93
3,50	112	73	1	10584	2,67
4,00	119	78	1	10585	2,91
4,25	119	78	1	10591	3,79
4,50	126	82	1	10593	3,45
5,00	132	87	1	10596	3,70
5,50	139	91	1	10599	4,90
6,00	139	91	1	10602	4,55
6,50	148	97	1	10605	5,59
7,00	156	102	1	10608	6,55
7,50	156	102	1	10611	6,94
8,00	165	109	1	10614	7,78
8,50	165	109	1	10617	8,61
9,00	175	115	1	10620	9,34
10,00	184	121	1	10623	9,96
11,00	195	128	1	10629	14,95
12,00	205	134	1	10632	17,05
13,00	205	134	1	10635	20,37



Línea 1 m - Ref. 1003



∅	2	2,5	3	3,25	3,5	4	4,25	4,5	5	5,5	6	6,5	7	7,5	8	8,5	9	10	12
Pcs	5	5	5	5	5	5	5	5	5	5	5	5	5	3	5	3	3	5	2

Ref. 4995 - N° Art. 71682: **444,32 €**

Display 15 - Ref. 1003



∅	7,5	8	8,5	9	10	11	12	13		
Pcs	5	5	3	3	3	2	2	2		
∅	4,25	4,25	4,5	5	5	5,5	6	6	6,5	7
Pcs	3	2	5	3	2	3	3	2	5	5
∅	2	2,5	3	3	3,25	3,25	3,5	3,5	4	4
Pcs	5	5	3	2	3	2	3	2	3	2

Ref. 4995 - N° Art. 22328: **499,12 €**

Ref. **1040**

BROCA MANGO CILÍNDRICO HSS EXTRA LARGA

HSS Straight Shank Extra Long Drill Bit
Foret queue cylindrique HSS extra-longue



HSS	DIN 1869 N	118°		Serie Extra Larga Extra Long Series Série extra-longue
------------	---------------	------	--	---

Aceros <850 N/mm ² Steel / Aciers	Fundición Cast Iron Fonte	Aluminio Aluminium
---	--	------------------------------

D mm	L mm	I mm		Nº Art.	€
2,00	125	85	1	12158	11,09
2,50	140	95	1	12161	11,59
3,00	150	100	1	12164	12,01
3,00	190	136	1	12167	13,87
3,50	165	115	1	12170	13,54
3,50	210	145	1	12173	15,61
3,50	265	180	1	12176	22,34
4,00	175	120	1	12179	13,54
4,00	220	150	1	12182	15,95
4,00	280	190	1	12185	22,76
4,50	185	125	1	12188	15,02
4,50	235	160	1	12191	18,74
4,50	295	200	1	12194	26,82
5,00	195	135	1	12197	15,85
5,00	245	170	1	12200	20,16
5,00	315	210	1	12203	24,77
5,50	205	140	1	12206	18,77
5,50	260	180	1	12209	26,82
5,50	330	225	1	12212	30,95
6,00	205	140	1	12215	18,77
6,00	260	180	1	12218	26,82
6,00	330	225	1	12221	30,95
6,50	215	150	1	12224	22,34
6,50	275	190	1	12227	28,83

D mm	L mm	I mm		Nº Art.	€
6,50	350	235	1	12230	35,92
7,00	225	155	1	12233	23,65
7,00	290	200	1	12236	32,94
7,00	370	250	1	12239	44,53
7,50	225	155	1	12242	26,64
7,50	290	200	1	12245	35,48
7,50	370	250	1	12248	51,70
8,00	240	165	1	12251	29,43
8,00	305	210	1	12254	40,77
8,00	390	265	1	12257	53,12
8,50	240	165	1	12260	40,06
8,50	305	210	1	12263	54,58
8,50	390	265	1	12266	75,07
9,00	250	175	1	12269	38,18
9,00	320	220	1	12272	50,43
9,00	410	280	1	12275	74,05
9,50	250	175	1	12278	44,99
9,50	320	220	1	12281	61,83
9,50	410	280	1	12284	83,30
10,00	265	185	1	12287	44,39
10,00	340	235	1	12290	58,08
10,00	430	295	1	12293	80,69
11,00	280	195	1	28866	56,21
12,00	295	205	1	28867	74,21



Ref. **1090**

BROCA MANGO CILÍNDRICO HSS LAMINADA

HSS Straight Shank Rolled Drill Bit
Foret queue cylindrique HSS laminé



HSS

Laminada
Rolled
Laminé



D mm	L mm	I mm	📦	Nº Art.	€
1,00	34	12	10	21440	0,33
1,50	40	18	10	21446	0,33
2,00	49	24	10	21452	0,33
2,50	57	30	10	21458	0,33
3,00	61	33	10	21464	0,33
3,25	65	36	10	21470	0,40
3,50	70	39	10	21473	0,46
4,00	75	43	10	21482	0,46

D mm	L mm	I mm	📦	Nº Art.	€
4,25	75	43	10	21485	0,55
4,50	80	47	10	21488	0,55
5,00	86	52	10	21494	0,58
5,50	93	57	10	21503	0,65
6,00	93	57	10	21509	0,68
6,50	101	63	10	21518	0,73
7,00	109	69	10	21527	1,04
7,50	109	69	10	21533	1,10

D mm	L mm	I mm	📦	Nº Art.	€
8,00	117	75	10	21542	1,21
8,50	117	75	10	21548	1,40
9,00	125	81	10	21554	1,75
10,00	133	87	10	21566	1,90
11,00	142	94	5	21581	2,42
12,00	151	101	5	21593	2,67
13,00	151	101	5	21608	3,12

Ref. **1009**

BROCA MANGO CILÍNDRICO HSS LAMINADA

HSS Straight Shank Rolled Drill Bit
Foret queue cylindrique HSS laminé



HSS

Laminada
Rolled
Laminé



D mm	L mm	I mm	📦	Nº Art.	€
1,00	34	12	2	30173	0,91 *
1,50	40	18	2	30175	0,91 *
2,00	49	24	2	30177	0,94 *
2,50	57	30	2	30179	0,94 *
3,00	61	33	2	30181	0,94 *
3,25	65	36	2	30182	1,07 *
3,50	70	39	2	30183	1,14 *
4,00	75	43	2	30185	1,14 *

D mm	L mm	I mm	📦	Nº Art.	€
4,25	75	43	1	30186	0,75
4,50	80	47	1	30187	0,83
5,00	86	52	1	30189	0,83
5,50	93	57	1	30191	0,91
6,00	93	57	1	30193	0,98
6,50	101	63	1	30195	1,03
7,00	109	69	1	30197	1,14
7,50	109	69	1	30199	1,33

D mm	L mm	I mm	📦	Nº Art.	€
8,00	117	75	1	30201	1,51
8,50	117	75	1	30203	1,70
9,00	125	81	1	30205	1,80
10,00	133	87	1	30209	2,24
11,00	142	94	1	30213	2,88
12,00	151	101	1	30217	3,51
13,00	151	101	1	30221	3,88

* € = 2 uds.



Set **1490**
6 Pcs

Cont. Ø	Nº Art.	€
2 - 3 - 4 - 5 - 6 - 8 mm	30204	4,91



Set **1491**
19 Pcs

Cont. Ø	Nº Art.	€
1 - 10 x 0,5 mm	30206	19,55



Set **1492**
25 Pcs

Cont. Ø	Nº Art.	€
1 - 13 x 0,5 mm	30210	39,25



Set **1499**
170 Pcs

Cont. Ø	Nº Art.	€
1-10 x 0,5 mm Ø 1-8: 10 pcs/Ø Ø 8,5-10: 5 pcs/Ø	69084	134,32



Ref. **1637**

TOPE PROFUNDIDAD DE BROCA

Drill Bit Depth Stop
Butées de perçage



C45

D mm		Nº Art.	€
3,00	1	13762	2,53
4,00	1	13763	2,84
5,00	1	13764	3,10
6,00	1	13765	3,47
8,00	1	13766	3,69
10,00	1	13767	3,90



6 Sets

Nº Art.	€
13768	111,32



Set 6 Pcs

Cont. Ø	Nº Art.	€
3-4-5-6-8-10 mm	81689	19,53

Ref. **1461**

SET TOPES DE PROFUNDIDAD DE BROCAS

Drill Bit Depth Stop Set
Jeu butées de perçage



13
pcs

Brocas Metal
Metal Drill Bits
Forets métal
3-4-5-6-8-10 mm

Topes de profundidad
Depth Stops
Butées de perçage



Nº Art.	€
79876	30,14

Llave Allen / Allen Wrench / Clé Allen 1 pc



Ref. **1110**

BROCA MANGO CÓNICO HSS

HSS Morse Taper Shank Drill Bit
Foret queue cône morse HSS

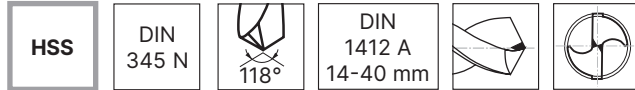

HSS	DIN 345 N	118°	DIN 1412 A 14-40 mm		
Aceros <850 N/mm² Steel / Aciers	Aceros <1000 N/mm² Steel / Aciers	Fundición Cast Iron Fonte	Cobre Copper Cuivre		



D mm	L mm	I mm	CM	Nº Art.	€	D mm	L mm	I mm	CM	Nº Art.	€	D mm	L mm	I mm	CM	Nº Art.	€
5,00	133	52	1	14426	14,76	16,50	223	125	2	14564	32,19	28,00	291	170	3	14702	81,03
5,25	133	52	1	14429	16,97	16,75	223	125	2	14567	37,04	28,25	296	175	3	14705	99,93
5,50	138	57	1	14432	14,76	17,00	223	125	2	14570	32,19	28,50	296	175	3	14708	86,88
5,75	138	57	1	14435	16,97	17,25	228	130	2	14573	40,97	28,75	296	175	3	14711	99,93
6,00	138	57	1	14438	14,76	17,50	228	130	2	14576	35,62	29,00	296	175	3	14714	86,88
6,25	144	63	1	14441	19,33	17,75	228	130	2	14579	40,97	29,25	296	175	3	14717	109,87
6,50	144	63	1	14444	15,70	18,00	228	130	2	14582	34,27	29,50	296	175	3	14720	95,53
6,75	150	69	1	14447	18,05	18,25	233	135	2	14585	45,08	29,75	296	175	3	14723	109,87
7,00	150	69	1	14450	15,70	18,50	233	135	2	14588	39,21	30,00	296	175	3	14726	95,53
7,25	150	69	1	14453	20,77	18,75	233	135	2	14591	45,08	30,25	301	180	3	14729	122,26
7,50	150	69	1	14456	16,89	19,00	233	135	2	14594	39,21	30,50	301	180	3	14732	106,31
7,75	156	75	1	14459	20,77	19,25	238	140	2	14597	49,07	30,75	301	180	3	14735	122,26
8,00	156	75	1	14462	16,83	19,50	238	140	2	14600	42,67	31,00	301	180	3	14738	106,31
8,25	156	75	1	14465	24,37	19,75	238	140	2	14603	49,07	31,25	301	180	3	14741	129,47
8,50	156	75	1	14468	18,31	20,00	238	140	2	14606	42,67	31,50	301	180	3	14744	112,57
8,75	162	81	1	14471	21,90	20,25	243	145	2	14609	50,87	31,75	306	185	3	14747	129,47
9,00	162	81	1	14474	18,31	20,50	243	145	2	14612	44,23	32,00	334	185	4	14750	112,57
9,25	162	81	1	14477	24,22	20,75	243	145	2	14615	50,87	32,50	334	185	4	14753	128,60
9,50	162	81	1	14480	18,08	21,00	243	145	2	14618	44,23	33,00	334	185	4	14756	128,60
9,75	168	87	1	14483	24,22	21,25	248	150	2	14621	56,12	33,50	334	185	4	14759	139,82
10,00	168	87	1	14486	17,76	21,50	248	150	2	14624	48,77	34,00	339	190	4	14762	139,82
10,25	168	87	1	14489	22,67	21,75	248	150	2	14627	56,12	34,50	339	190	4	14765	152,79
10,50	168	87	1	14492	19,69	22,00	248	150	2	14630	48,77	35,00	339	190	4	14768	152,79
10,75	175	94	1	14495	22,67	22,25	248	150	2	14633	61,40	35,50	339	190	4	14771	163,94
11,00	175	94	1	14498	19,69	22,50	253	155	2	14636	53,39	36,00	344	195	4	14774	163,94
11,25	175	94	1	14501	23,84	22,75	253	155	2	14639	61,40	36,50	344	195	4	14777	172,81
11,50	175	94	1	14504	20,74	23,00	253	155	2	14642	53,39	37,00	344	195	4	14780	172,81
11,75	175	94	1	14507	23,84	23,25	276	155	3	14645	67,74	37,50	344	195	4	14783	181,77
12,00	182	101	1	14510	20,74	23,50	276	155	3	14648	58,90	38,00	349	200	4	14786	181,77
12,25	182	101	1	14513	26,54	23,75	281	160	3	14651	67,74	38,50	349	200	4	14789	193,85
12,50	182	101	1	14516	22,21	24,00	281	160	3	14654	58,90	39,00	349	200	4	14792	193,85
12,75	182	101	1	14519	26,54	24,25	281	160	3	14657	73,89	39,50	349	200	4	14795	204,69
13,00	182	101	1	14522	23,10	24,50	281	160	3	14660	64,23	40,00	349	200	4	14798	204,69
13,25	189	108	1	14525	29,20	24,75	281	160	3	14663	73,89	40,50	354	205	4	14801	215,23
13,50	189	108	1	14528	24,39	25,00	281	160	3	14666	64,23	41,00	354	205	4	14804	215,23
13,75	189	108	1	14531	29,20	25,25	286	165	3	14669	80,38	41,50	354	205	4	14807	228,39
14,00	189	108	1	14534	24,39	25,50	286	165	3	14672	69,88	42,00	354	205	4	14810	228,39
14,25	212	114	2	14537	31,62	25,75	286	165	3	14675	80,38	42,50	354	205	4	14813	239,57
14,50	212	114	2	14540	27,52	26,00	286	165	3	14678	69,88	43,00	359	210	4	14816	239,57
14,75	212	114	2	14543	31,62	26,25	286	165	3	14681	87,03	43,50	359	210	4	14819	250,81
15,00	212	114	2	14546	27,52	26,50	286	165	3	14684	75,68	44,00	359	210	4	14822	250,81
15,25	218	120	2	14549	32,74	26,75	291	170	3	14687	87,03	44,50	359	210	4	14825	261,87
15,50	218	120	2	14552	28,46	27,00	291	170	3	14690	75,68	45,00	359	210	4	14828	261,87
15,75	218	120	2	14555	32,74	27,25	291	170	3	14693	93,14	45,50	364	215	4	14831	272,93
16,00	218	120	2	14558	28,46	27,50	291	170	3	14696	81,03	46,00	364	215	4	14834	272,93
16,25	223	125	2	14561	37,04	27,75	291	170	3	14699	93,14	46,50	364	215	4	14837	284,03





Ref. **1110**

BROCA MANGO CÓNICO HSS

HSS Morse Taper Shank Drill Bit
Foret queue cône morse HSS

D mm	L mm	I mm	CM	Nº Art.	€
47,00	364	215	4	14840	284,03
47,50	364	215	4	14843	293,59
48,00	369	220	4	14846	293,59
48,50	369	220	4	14849	304,86
49,00	369	220	4	14852	304,86
49,50	369	220	4	14855	315,93
50,00	369	220	4	14858	315,93
51,00	412	225	5	14864	372,96
52,00	412	225	5	14867	397,64
53,00	412	225	5	14870	424,30
54,00	417	230	5	14873	469,18
55,00	417	230	5	14876	462,94
56,00	417	230	5	14879	522,56
57,00	422	235	5	14882	552,95
58,00	422	235	5	14885	556,39
59,00	422	235	5	14888	574,32
60,00	422	235	5	14891	546,05
61,00	427	240	5	14894	639,13
62,00	427	240	5	14897	665,67
63,00	427	240	5	14900	703,96

D mm	L mm	I mm	CM	Nº Art.	€
64,00	432	245	5	14903	742,73
65,00	432	245	5	14906	713,28
66,00	432	245	5	14909	801,66
67,00	432	245	5	14912	827,54
68,00	437	250	5	14915	849,02
69,00	437	250	5	14918	875,37
70,00	437	250	5	14921	829,99

>70 mm bajo demanda
upon request / sur demande

71,00	437	250	5	14924	958,25
72,00	442	255	5	14927	978,10
73,00	442	255	5	14930	1.003,72
74,00	442	255	5	14933	1.033,08
75,00	442	255	5	14936	973,11
76,00	447	260	5	14939	1.145,88
77,00	514	260	6	14942	1.229,66
78,00	514	260	6	14945	1.253,68
79,00	514	260	6	14948	1.278,92
80,00	514	260	6	14951	1.349,25

D mm	L mm	I mm	CM	Nº Art.	€
81,00	519	265	6	14954	1.485,54
82,00	519	265	6	14957	1.522,65
83,00	519	265	6	14960	1.551,87
84,00	519	265	6	14963	1.584,82
85,00	519	265	6	14966	1.623,97
86,00	524	270	6	14969	1.659,42
87,00	524	270	6	14972	1.694,70
88,00	524	270	6	14975	1.738,24
89,00	524	270	6	14978	1.771,85
90,00	524	270	6	14981	1.822,61
91,00	529	275	6	14984	1.922,31
92,00	529	275	6	14987	1.933,37
93,00	529	275	6	14990	2.002,33
94,00	529	275	6	14993	2.043,03
95,00	529	275	6	14996	2.085,01
96,00	534	280	6	14999	2.153,72
97,00	534	280	6	15002	2.171,76
98,00	534	280	6	15005	2.220,20
99,00	534	280	6	15008	2.260,35
100,00	534	280	6	15011	2.303,45



Set 25 Pcs

Cont. Ø	Nº Art.	€
14-14,5-15-15,5-16-16,5-17-17,5-18-18,5-19-19,5-20-20,5-21-21,5-22-22,5-23-24-25-26-27-28-30 mm	14263	1.303,05



Set 10 Pcs

Cont. Ø	Nº Art.	€
14-15-16-17-18-19-20-21-22-25 mm	19346	436,99

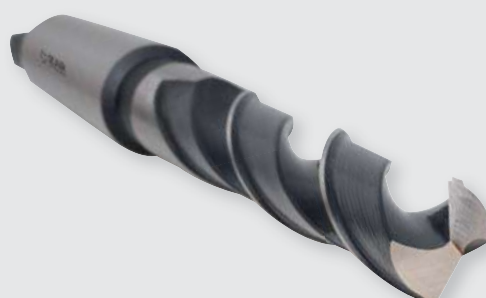

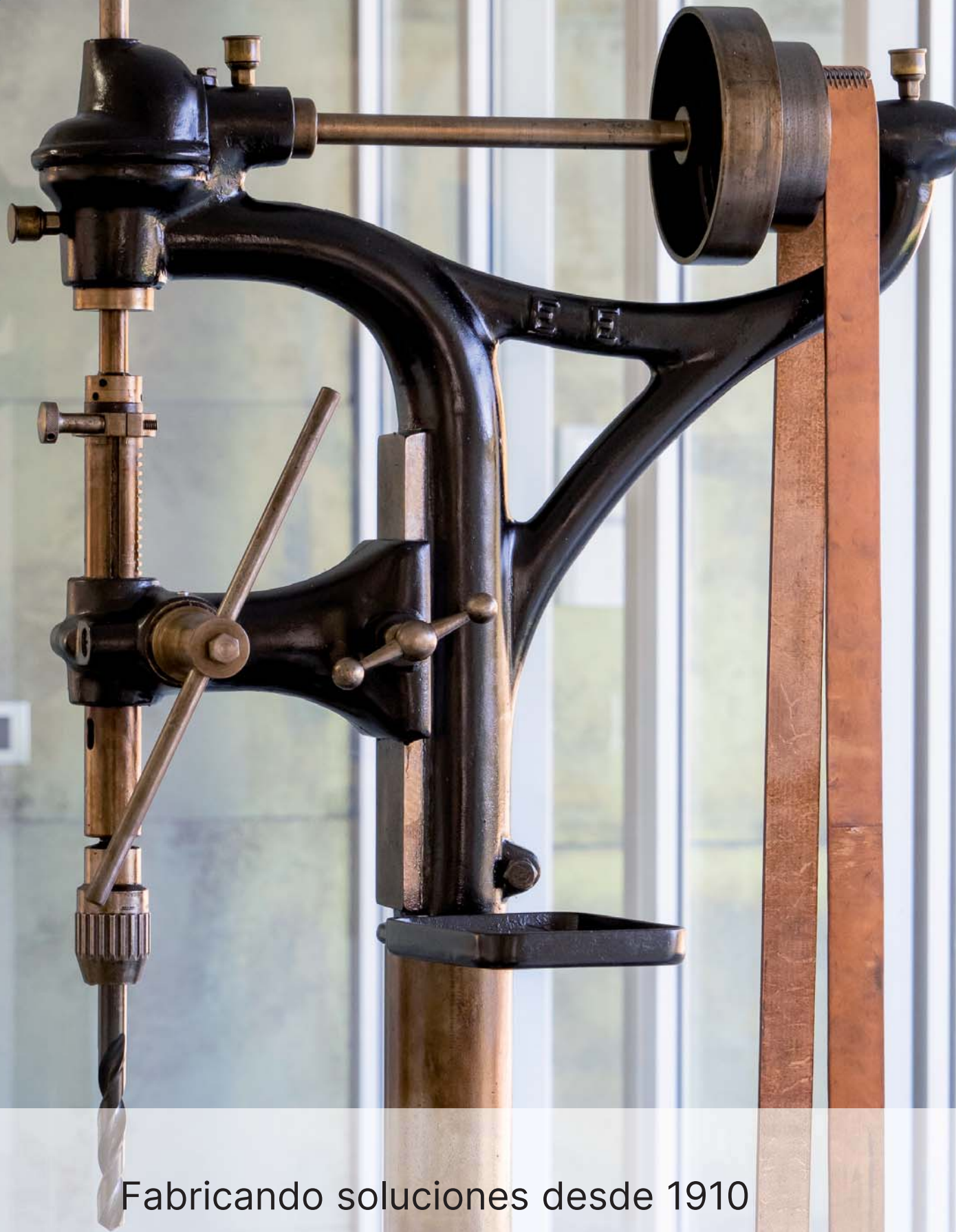

Fabricando soluciones desde 1910

izartool.com

PORTABROCAS Y ACCESORIOS

Drill Chucks & Accessories

Mandrins et accessoires

Ref. **1802**

PORTABROCAS TALADROS PORTÁTILES CON LLAVE

Portable Drilling Machine Metal Drill-Chucks with Key

Mandrins métal perceuses portables avec clé



Mod. Monoblock

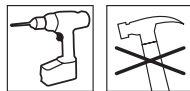

- | | | |
|------------------------------|-------------------------|-------------------------|
| - 1 única pieza | - Only one piece | - 1 Seule pièce |
| - Elimina roturas de dientes | - No teeth breaking | - Pas de casse de dents |
| - Ideal taladro portátil | - Ideal portable drills | - Perceuses à main |
| - Cierre con llave | - Key-lock | - Fermeture à clé |
| - Cuerpo metal | - Metal body | - Corps Métal |
| - Agujero interior | - Internal hole | - Trou intérieur |

Monoblock

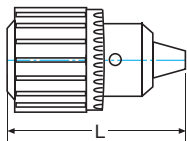

Mod.	Cap. mm	Fijación Fix.	L mm	Peso Weight Poids gr.	Nº Art.	€
00102	1-10	1/2X20 UNF	60	299	47491	18,70
00131	1,5-13	3/8X24 UNF	77	501	47493	20,66



2 Pcs.

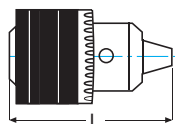

Mod.	Cap. mm	Fijación Fix.	L mm	Peso Weight Poids gr.	Nº Art.	€
00101	1-10	3/8X24 UNF	60	311	47490	18,70
00132	1,5-13	1/2X20 UNF	77	492	47494	20,66

Ref. **1807**

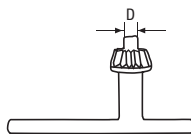

D mm	Mod.	Nº Art.	€
6	00102	16362	3,35
	00101		
	00132		
6,3	00131	69316	3,98





Ref. **1806**

PORTABROCAS TALADROS PORTÁTILES - AUTOMÁTICO METAL

Portable Drilling Machine Drill-Chucks - Metal Automatic
Mandrins perceuses portables – automatique métal

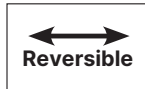

- | | | |
|---------------------------------|-----------------------------|--------------------------------|
| - Cierre seguridad | - Security lock | - Fermeture sureté |
| - Capacidad 13: Garras MD | - Capacity 13: carbide jaws | - Capacité 13: pinces carbure |
| - Ideal atornilladores | - Ideal screwdrivers | - Idéal Tournevis |
| - Taladros percusión de batería | - Battery percussion drills | - Perceuses percusion batterie |
| - Reversible | - Reversible | - Reversible |
| - Cuerpo metal ligero | - Light metal body | - Corps métal léger |
| - Agujero interior | - Internal hole | - Trou intérieur |
| - No apto martillos SDS | - Not suitable SDS | - Non apte pour SDS |

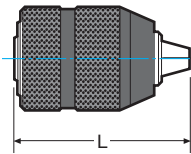

Mod.	Cap. mm	Fijación Fix.	L mm	Peso Weight Poids gr.	Nº Art.	€
00101	1-10	3/8X24 UNF	64,5	311	14706	43,78
00102	1-10	1/2x20 UNF	64,5	313	14712	43,78
00131	2-13	3/8X24 UNF	74,5	397	14718	63,11
00132	2-13	1/2X20 UNF	74,5	328	14736	63,11



Ref. **1804**

PORTABROCAS TALADROS PORTATILES Y ESTACIONARIOS

Portable & Stationary Drilling Machine Drill-Chucks
Mandrins perceuses portables et fixes



- | | | |
|--|---|--|
| - Cierre seguridad | - Security lock | - Fermeture sureté |
| - Taladros industriales y percusión (aptos martillos alta frecuencia SDS plus) | - Industrial & percussion drills (suitable high frequency hammers SDS plus) | - Perceuses industrielles et précisions (aptés pour marteaux haute fréquence SDS plus) |
| - Autoapriete automático | - Automatic self-tightening | - Auto-attachement |

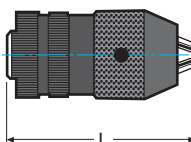

Mod.	Cap. mm	Fijación Fix.	L mm	Peso Weight Poids gr.	Nº Art.	€
00101	0-10	3/8X24 UNF	74	350	16358	78,74
00102	0-10	1/2x20 UNF	77	593	16359	78,74
00132	1-13	1/2X20 UNF	96	670	16361	84,79



Ref. **1803**

PORTABROCAS PRECISIÓN TALADROS PORTATILES Y ESTACIONARIOS

Portable & Stationary Drilling Machine Precision Drill-Chucks

Mandrins précision perceuses portables et fixes



→
Derecha
Right - Droite



- Uso Taladros industriales y profesionales
- Fijaciones: Rosca taladro portátil y Cónica taladro fijo
- Autoapriete automático
- Giro a derechas

- Use for Industrial & professional drills
- Fixing: Threaded portable drills & Tapered for fixed drills
- Automatic self-tightening
- Right turning

- Usage perceuses industrielles et professionnelles
- Fixations: Filet perceuse portable et conique perceuse à colonne
- Amenchement automatique
- Tour à droite

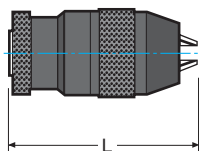

Mod.	Cap. mm	Fijación Fix.	L mm	Peso Weight Poids gr.	Nº Art.	€	Garras Jaws Pincas Art.
00101	0,8-10	B12 *	86	619	16349	71,62	56894
00102	0,8-10	3/8X24 UNF	78	451	16350	71,62	56894
00103	0,8-10	1/2X20UNF	78	452	16351	71,62	56894
00131	1-13	B16 *	103	800	16352	77,09	24565
00132	2-13	3/8X24 UNF	83	764	16353	77,09	56894
00133	2-13	1/2X20 UNF	83	583	16354	77,09	56894
00161	3-16	B16	105	1.180	16355	131,15	24565
00162	3-16	B18 *	105	1.152	16356	131,15	24565
00163	3-16	1/2X20 UNF	105	1.185	16357	131,15	24565
00164	5-20	B18 *	131	2.165	19957	165,53	24566



*** RECOMENDACIONES:**

1. Limpiar muy bien la espiga y el agujero del portabrocas antes de introducir la espiga.
2. Cogiendo el porta-brocas en una mano, insertar la espiga con la otra mano.
3. Dar un pequeño golpe seco con una maza de Nylon.

*** RECOMMENDATIONS:**

1. Thoroughly clean the spindle and the chuck-hole before inserting the spindle.
2. Holding the chuck in one hand, insert the spike with the other hand.
3. Give a small heavy thud with a Nylon mace.

*** RECOMMANDATIONS :**

1. Nettoyez soigneusement l'arbre d'attachement et le trou du mandrin avant d'insérer l'arbre.
2. En tenant le mandrin d'une main, insérez l'arbre avec l'autre main.
3. Donnez un petit coup sec avec un masse en nylon.



Ref. **1809**

ACCESORIOS

Accessories
Accessoires

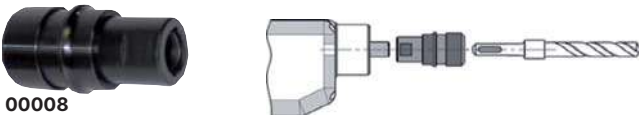
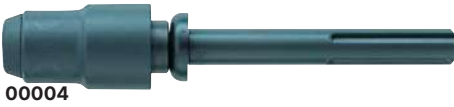



Conversores / Converters / Convertisseurs

Mod.	Entrada Inlet Entrée	Fijación Fix	Nº Art.	€
00001	3/8X24h	3/8X24h	16363	3,88
00002	3/8X24h	1/2X20h	16364	4,55
00003	SDS plus	1/2X20h	16365	21,55
00004	SDS max	SDS plus	17258	123,29
00005	Hex. 13 mm	SDS plus	17259	133,68
00008	1/2x20h	SDS plus	20485	66,71
New! 00021	Hexagonal	M14	24273	12,10

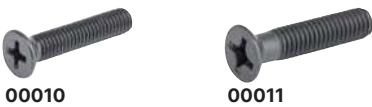

Tornillos / Screws / Vis



Mod.	Entrada Inlet Entrée	Fijación Fix		Nº Art.	€
00010	M5x18 mm	3/8x24	1	25321	0,43
00011	M6x25 mm	1/2x20	1	25323	0,43

Ref. **1819**

GARRAS

Jaws
Pinces

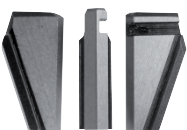

Mod.	Garras Jaws Pinces	Nº Art.	€
1013ROS	10/13 mm ROSCA (Ref. 1803)	56894	38,07
13DIN16	13DIN / 16 mm (Ref. 1803)	24565	40,08
16	16 mm	24566	40,53



Línea 1 m 18PB - Refs. 1802 - 1803 - 1804 - 1806 - 1807 - 1809

PORTABROCAS TALADROS PORTATILES Y ESTACIONARIOS

Portable & Stationary Drilling Machine Drill-Chucks

Mandrins perceuses portables et fixes



	Ref. 1802	Ref. 1802	Ref. 1803	Ref. 1803	Ref. 1804	Ref. 1804	Ref. 1806	Ref. 1806	Ref. 1807	Ref. 1809
∅	Cap. 1-10 Fix 1/2 x 20h	Cap. 1,5-13 Fix 1/2 x 20h	Cap. 0,8-10 Fix 1/2 x 20h	Cap. 2-13 Fix 1/2 x 20h	Cap. 1-13 Fix 1/2 x 20h	Cap. 1-13 Fix 1/2 x 20h	Cap. 1-10 Fix 1/2 x 20h	Cap. 2-13 Fix 1/2 x 20h	Llave Key - Clé D 6 mm	SDS plus Fix 1/2 x 20h
Pcs	2	2	2	2	1	1	2	2	3	5

Ref. 4995 - N° Art. 72080: **877,30 €**

Línea 33 cm 18PB - Refs. 1802 - 1803 - 1806

PORTABROCAS TALADROS PORTATILES Y ESTACIONARIOS

Portable & Stationary Drilling Machine Drill-Chucks

Mandrins perceuses portables et fixes



	Ref. 1802	Ref. 1803	Ref. 1803	Ref. 1806	Ref. 1806
∅	Cap. 1,5-13 Fix 1/2 x 20h	Cap. 0,8-10 Fix 1/2 x 20h	Cap. 2-13 Fix 1/2 x 20h	Cap. 1-10 Fix. 1/2 x 20h	Cap. 2-13 Fix 1/2 x 20h
Pcs	2	2	2	2	2

Ref. 4995 - N° Art. 72081: **552,52 €**

Display 12 - Refs. 1802 - 1803 - 1804 - 1806 - 1807 - 1809

PORTABROCAS TALADROS PORTATILES Y ESTACIONARIOS

Portable & Stationary Drilling Machine Drill-Chucks

Mandrins perceuses portables et fixes



∅	Ref. 1802 Cap. 1-10 Fix. 1/2 x 20h	Ref. 1802 Cap. 1,5-13 Fix. 1/2 x 20h	Ref. 1806 Cap. 1-10 Fix. 1/2 x 20h	Ref. 1806 Cap. 1-10 Fix. 1/2 x 20h	Ref. 1806 Cap. 2-13 Fix. 1/2 x 20h	Ref. 1806 Cap. 2-13 Fix. 1/2 x 20h
Pcs	2	2	1	1	1	1
∅	Ref. 1803 Cap. 0,8-10 Fix. 1/2 x 20h	Ref. 1803 Cap. 2-13 Fix. 1/2 x 20h	Ref. 1804 Cap. 1-13 Fix. 1/2 x 20h	Ref. 1804 Cap. 1-13 Fix. 1/2 x 20h	Ref. 1809 SDS plus Mod. 00003	Ref. 1807 Llave Key - Clé D 6 mm
Pcs	2	2	1	1	5	5

Ref. 4995 - N° Art. 22334: **884,00 €**



Ref. **1101**

CONO REDUCTOR

Reduction Sleeve
Douille de réduction



HSS

DIN
2185

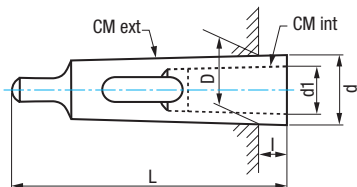

CM EXT.	CM INT.	L mm	I mm	D mm	d1 mm	d mm	N° Art.	€
2	1	92	17,00	17,780	12,065	18,60	16415	19,38
3	1	99	5,00	23,825	12,065	24,10	16416	26,56
3	2	112	18,00	23,825	17,780	24,70	16417	26,94
4	1	124	6,50	31,267	12,065	31,60	16418	42,29
4	2	124	6,50	31,267	17,780	31,60	16419	42,29
4	3	140	22,50	31,267	23,825	32,40	16420	42,29
5	3	156	6,50	44,399	23,825	44,70	16421	65,04
5	4	171	21,50	44,399	31,267	45,50	16422	65,30



Ref. **1102**

ALARGADOR CONOS

Extension Socket
Douille d'augmentation



HSS

DIN
2187

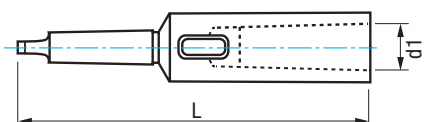

CM EXT.	CM INT.	L mm	d1 mm	N° Art.	€
1	2	160	17,78	16423	46,87
2	1	159	12,07	16427	36,29
2	2	176	17,78	16433	48,05
2	3	195	23,83	16424	61,89
3	1	176	12,07	16428	38,71
3	2	194	17,78	16429	45,64
3	3	215	23,83	16434	69,93
3	4	239	31,27	16425	92,84
4	1	200	12,07	16430	64,75
4	2	215	17,78	16431	65,46
4	3	240	23,83	16432	76,24
4	4	265	31,27	16435	110,17
4	5	299	44,39	16426	218,14



Ref. **1103**

ESPIGA SUJECIÓN

Spike CM Taper
Arbre d'attachement



HSS

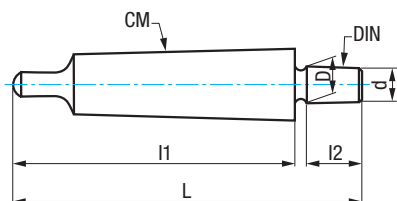

CM	DIN	L mm	l1 mm	D mm	d mm	l2 mm		Nº Art.	€
1	B12	89,00	62,00	12,065	11,10	18,50	1	16440	12,24
2	B12	106,00	75,00	12,065	11,10	18,50	1	16441	13,21
2	B16	111,00	75,00	15,733	14,50	24,00	1	16442	13,21
2	B18	118,00	75,00	17,780	16,20	32,00	1	16443	13,21
3	B12	126,00	94,00	12,065	11,10	18,50	1	16444	16,06
3	B16	134,00	94,00	15,733	14,50	24,00	1	16445	16,06
3	B18	140,00	94,00	17,780	16,20	32,00	1	21873	16,06
4	B16	158,00	117,50	15,733	14,50	24,00	1	16446	24,65
4	B18	166,50	117,50	17,780	16,20	32,00	1	16447	24,65
5	B16	194	149,50	15,733	14,50	24,00	1	66764	70,27
5	B18	202	149,50	17,780	16,20	32,00	1	66765	70,27



Ref. **1104**

CUÑA EXPULSORA

Drill Drift
Chasse cône standard



HSS

CM Ext. min.	CM Ext. max.	L mm		Nº Art.	€
1	2	116	1	16436	11,57
2	3	150	1	16437	13,98
3	4	199	1	16438	18,53
4	5	251	1	16439	25,03



Ref. **9994**

MÁQUINA AFILADORA BROCAS

Drill Bit Sharpening Machine
Machine affûteuse forets



Mod. **XP**



Cap. mm	Punta Point Pointe	Uso Use Usage	Nº Art.	€
2,5-13	118°	HSS, TIN, HSSE, MD / HM / Carbure, Pared / Masonry / Béton + Split Point	38416	165,84

Incluida Muela y medidor de ángulos
Wheel & Angle Meter included
Compris meule et compteur d'angle



Mod. **500**



Cap. mm	Punta Point Pointe	Uso Use Usage	Nº Art.	€
2,5-13	118°-135°	HSS, TIN, HSSE, MD / HM / Carbure, Pared / Masonry / Béton + Split Point	45121	337,20

Incluida Muela K180 y medidor de ángulos
Wheel K180 & Angle Meter included
Compris meule K180 et compteur d'angle



Mod. **750**



Cap. mm	Punta Point Pointe	Uso Use Usage	Nº Art.	€
2,5-19	115°-140°	HSS, TIN, HSSE, MD / HM / Carbure, Pared / Masonry / Béton + Split Point	38418	386,09

Incluida Muela K180 y medidor de ángulos
Wheel K180 & Angle Meter included
Compris meule K180 et compteur d'angle



* INSTRUCCIONES USO / Directions for use / Instructions d'emploi

PIEZAS RECAMBIO - Spare Parts - Pieces rechange

Porta Brocas - Drill Chucks - Mandrins

Mod.	Cap. mm	Punta Point Pointe	Nº Art.	€
XP	2,5-13	118°	39712	76,70
500	2,5-13	118°-135°	47218	76,70
500-750	2,5-19	115°-140°	40343	107,55

Muela - Wheel - Meule

Mod.	Grano Grain	Máquina Machine	Cap. mm	Nº Art.	€
K180	Fino Fine Fin	XP-500-750	2,5-19	40344	53,67
K100	Grueso Coarse Gros	750	13-19	43414	53,67



BROCAS ESPECIALES

Special Drill Bits

Forets Spéciales

Ref. **1602**

BROCA ESCALONADA HSS

HSS Step Drill Bit
Foret étagé HSS



- Nueva punta robusta autocentrante
- Avellanado especial 45°
- Menor desgaste y esfuerzo de corte
- Mayor rendimiento y vida útil de la herramienta
- Mejor evacuación de viruta
- Acabado sin rebabas

- New autocentering robust point
- Special 45° Countersinking
- Lower wear and cutting effort
- Better performance & longer tool life
- Better chipping-off
- No-burr finishing

- Nouvelle pointe plus robuste autocentrante
- Ébavurage spécial à 45°
- Réduction de l'usure et de l'effort de coupe
- Augmentation de la performance et vie utile de l'outil
- Meilleure évacuation des copeaux
- Finition sans bavures

HSS					Chapa Sheets Tôle	Materiales ferrosos Ferrous Materials Matériaux ferreux
-----	--	--	--	--	-------------------------	---

Aceros <850 N/mm ² Steel / Aciers	Plásticos Plastics Plastiques
--	-------------------------------------

Cap. mm	Nº Pasos Steps / Étages	d mm	L mm	Nº Art.	€
4-12	9 (4-5-6-7-8-9-10-11-12)	6	79	12048	40,61
4-20	9 (4-6-8-10-12-14-16-18-20)	9	67	12054	51,63
4-30	14 (4-6-8-10-12-14-16-18-20-22-24-26-28-30)	10	100	66484	68,30
6-30	13 (6-8-10-12-14-16-18-20-22-24-26-28-30)	10	100	12060	75,89
7-37	8 (7-12,5-15,2-18,6-20,4-22,5-28,3-37)	12	90	67619	148,04
9-36	10 (9-12-15-18-21-24-27-30-33-36)	12	82	12066	136,52
12-20	9 (12-13-14-15-16-17-18-19-20)	9	75	56798	56,31
20-30	11 (20-21-22-23-24-25-26-27-28-29-30)	12	88	56799	82,09
30-40	11 (30-31-32-33-34-35-36-37-38-39-40)	13	98	60715	123,23
40-50	11 (40-41-42-43-44-45-46-47-48-49-50)	13	112	60716	190,99
50-60	11 (50-51-52-53-54-55-56-57-58-59-60)	13	120	60717	285,77



Set 3 Pcs

Cont.	Nº Art.	€
4-12, 4-20, 6-30 mm	43518	168,13



Ref. **1622**

New!



Pag. 333



BROCA ESCALONADA ESPIRAL MANGO E6.3

E6.3 Shank Spiral Step Drill Bit
Foret étagé spirale queue E6.3



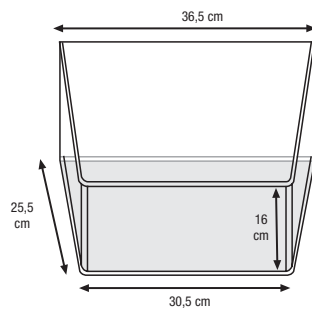

15 Pcs

Nº Art.	€
65184	1.486,09

Cap. mm	Nº Art.	Uds.
4-12	12048	2
4-20	12054	2
6-30	12060	2
9-36	12066	2
12-20	56798	2
20-30	56799	2
30-40	60715	1
40-50	60716	1
50-60	60717	1

Línea 33 cm - Ref. 1602



∅	4-12	4-20	4-30	6-30	9-36	12-20
Pcs	1	1	1	1	1	1

Ref. 4995 - Nº Art. 70954: 429,26 €

Ref. **1612**

BROCA ESCALONADA **ESPIRAL** HSS

HSS **Spiral** Step Drill Bit
Foret étagé **spirale** HSS



- Canal optimizado para virutas largas y complejas
- Avellanado especial 45°
- Filos de corte protegidos y muy afilados
- Sin rebabas
- Mayor vida útil en materiales muy duros
- Auto centrado en chapas finas

- Optimized channel for long and complex chips
- Special 45° Countersinking
- Very sharpened & protected cutting edges
- No burrs
- Longer tool life in very hard materials
- Autocentering in fine sheets

- Goujure optimisée pour copeaux longs et complexes
- Ébavurage special à 45°
- Filets des arêtes de coupe protégés et plus affûtés
- Sans bavures
- Vie utile plus longue pour aciers plus durs
- Auto centrage sur toles minces

HSS					Chapa Sheets Tôle	Materiales ferrosos Ferrous Materials Matériaux ferreux
-----	--	--	--	--	-------------------------	---

Aceros
<850 N/mm²
Steel / Aciers

Plásticos
Plastics
Plastiques

Cap. mm	Nº Pasos Steps / Étages	d mm	L mm	Nº Art.	€
4-12	9 (4-5-6-7-8-9-10-11-12)	6	80	67360	42,26
4-20	9 (4-6-8-10-12-14-16-18-20)	9	69	67366	59,97
6-30	13 (6-8-10-12-14-16-18-20-22-24-26-28-30)	10	99	67368	87,22
6-38	12 (6-9-13-16-19-21-23-26-29-32-35-38)	12	97	69557	171,53



Set 3 Pcs

Cont.	Nº Art.	€
4-12, 4-20, 6-30 mm	67357	189,45

Línea 33 cm - Ref. 1612



∅	4-12	4-20	6-30	6-38
Pcs	1	1	1	1

Ref. 4995 - Nº Art. 70958: **360,98 €**





Ref. **1607**

BROCA ESCALONADA HSSE INOX

Stainless HSSE Step Drill Bit
Foret étagé HSSE Inox



- Nueva punta robusta autocentrante
- Avellanado especial 45°
- Menor desgaste y esfuerzo de corte
- Mayor rendimiento y vida útil de la herramienta
- Mejor evacuación de viruta
- Acabado sin rebabas

- New autocentering robust point
- Special 45° Countersinking
- Lower wear and cutting effort
- Better performance & longer tool life
- Better chipping-off
- No-burr finishing

- Nouvelle pointe plus robuste autocentrante
- Ébavurage special à 45°
- Réduction de l'usure et de l'effort de coupe
- Augmentation de la performance et vie utile de l'outil
- Meilleure évacuation des copeaux
- Finition sans bavures

HSSE
5% Co

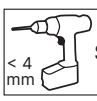
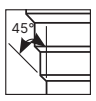
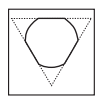
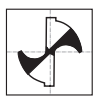

Chapa
Sheets
Tôle

Materiales ferrosos
Ferrous Materials
Matériaux ferreux

Aceros
<850 N/mm²
Steel / Aciers

INOX
Stainless Steel
Acier INOX

Cobre
Copper
Cuivre

Aluminio
Aluminium

Plásticos
Plastics
Plastiques

Cap. mm	Nº Pasos Steps / Étages	d mm	L mm	Nº Art.	€
4-12	9 (4-5-6-7-8-9-10-11-12)	6	79	12072	48,72
4-20	9 (4-6-8-10-12-14-16-18-20)	8	67	12078	61,97
6-30	13 (6-8-10-12-14-16-18-20-22-24-26-28-30)	10	100	12084	91,06
9-36	10 (9-12-15-18-21-24-27-30-33-36)	12	82	67299	163,82
12-20	9 (12-13-14-15-16-17-18-19-20)	9	75	60835	67,58
20-30	11 (20-21-22-23-24-25-26-27-28-29-30)	12	88	60837	98,50
30-40	11 (30-31-32-33-34-35-36-37-38-39-40)	13	98	60838	154,03
40-50	11 (40-41-42-43-44-45-46-47-48-49-50)	13	112	60839	229,19
50-60	11 (50-51-52-53-54-55-56-57-58-59-60)	13	120	60840	342,92



Set 3 Pcs

Cont.	Nº Art.	€
4-12, 4-20, 6-30 mm	43519	201,75

Línea 33 cm - Ref. 1607



Ø	4-12	4-20	6-30	9-36	12-20
Pcs	1	1	1	1	1

Ref. 4995 - Nº Art. 70961: **433,15 €**



Ref. **1617**

BROCA ESCALONADA **ESPIRAL** HSSE INOX

Stainless HSSE Spiral Step Drill Bit

Foret étagé spirale HSSE Inox



- Canal optimizado para virutas largas y complejas
- Avellanado especial 45°
- Filos de corte protegidos y muy afilados
- Sin rebabas
- Mayor vida útil en materiales muy duros
- Autocentrado en chapas finas
- Optimized channel for long and complex chips
- Special 45° Countersinking
- Very sharpened & protected cutting edges
- No burrs
- Longer tool life in very hard materials
- Autocentering in fine sheets
- Goujure optimisée pour copeaux longs et complexes
- Ébavurage special à 45°
- Filets des arêtes de coupe protégés et plus affûtés
- Sans bavures
- Vie utile plus longue pour aciers plus durs
- Autocentrage sur toles minces

HSSE
5% Co

Chapa
Sheets
Tôle

Materiales ferrosos
Ferrous Materials
Matériaux ferreux

Aceros
<850 N/mm²
Steel / Aciers

INOX
Stainless Steel
Acier INOX

Cobre
Copper
Cuivre

Aluminio
Aluminium

Plásticos
Plastics
Plastiques

Cap. mm	Nº Pasos* Steps* / Étages*	d mm	L mm	Nº Art.	€
4-12	9 (4-5-6-7-8-9-10-11-12)	6	80	67314	50,73
4-20	9 (4-6-8-10-12-14-16-18-20)	9	69	67316	71,98
6-30	13 (6-8-10-12-14-16-18-20-22-24-26-28-30)	10	99	67318	104,64



Set 3 Pcs

Cont.	Nº Art.	€
4-12, 4-20, 6-30 mm	67317	227,35

Línea 33 cm - Ref. 1617



ø	4-12	4-20	6-30
Pcs	1	1	1

Ref. 4995 - Nº Art. 70964: 227,35 €





Ref. **1603**

BROCA TUBO/CHAPA

Tube-Sheet Drill Bit
Foret ampli-trou



- Nueva geometría
- Menor desgaste, mayor vida útil de la herramienta
- Mayor velocidad de corte
- Materia prima de última generación

- New geometry
- Lower wear and longer tool life
- Higher cutting speed
- Last generation raw material

- Nouvelle Géométrie
- Réduction de l'usure, vie plus longue de l'outil
- Augmentation de la vitesse de coupe
- Matière première dernière génération



Aceros
<850 N/mm²
Steel / Aciers

Plásticos
Plastics
Plastiques

Cap. mm	d mm	L mm	Nº Art. HSS	€	Cap. mm	d mm	L mm	Nº Art. HSS	€
3-14	6	60	12090	16,01	26-40	12	85	69922	90,91
4-25,4	10	90	69921	42,98	36-50	12	97	12100	132,62
5-20	8	66	69920	26,60	40-61*	13	103	12102	221,28
8-20	8	62	69924	23,00	46-60	13	96	69923	221,28
16-30,5	10	72	12096	43,93					



* Cap. hasta fin de existencias / while stock lasts / jusqu'à la fin de stock

Línea 33 cm - Ref. 1603



∅	3-14	4-25,4	5-20	16-30,5	36-50
Pcs	1	1	1	1	1

Ref. 4995 - Nº Art. 72084: 262,14 €



Ref. **1609**

BROCA TUBO/CHAPA

Tube-Sheet Drill Bit
Foret ampli-trou



- Nueva geometría
- Menor desgaste, mayor vida útil de la herramienta
- Mayor velocidad de corte
- Materia prima de última generación

- New geometry
- Lower wear and longer tool life
- Higher cutting speed
- Last generation raw material

- Nouvelle Géométrie
- Réduction de l'usure, vie plus longue de l'outil
- Augmentation de la vitesse de coupe
- Matière Première dernière génération

HSSE 5% Co				Chapa Sheets Tôle	Metal no ferroso Non-Ferrous Metal Métal non ferreux
----------------------	--	--	--	--------------------------------	---

Aceros <850 N/mm ² Steel / Aciers	INOX Stainless Steel Acier INOX	Plásticos Plastics Plastiques
---	--	--

Cap. mm	d mm	L mm	Nº Art.	€
3-14	6	60	12108	31,11
4-30,5	10	102	69926	104,62
8-20	8	62	69925	41,20
16-30,5	10	72	12111	68,00



Línea 33 cm - Ref. 1609



∅	3-14	4-30,5	8-20	16-30,5
Pcs	1	1	1	1

Ref. 4995 - Nº Art. 72087: 244,93 €



Ref. **1604**

BROCA CORTA PUNTOS SOLDADURA

Welding Point Jobber Drill Bit
Foret courte points soudure



HSSE
5% Co



Serie Corta
Jobber Series
Série courte

D mm	L mm	I mm	N° Art.	€
6,00	66	28	16326	10,85
8,00	80	37	16327	13,83
10,00	89	43	66909	17,32



Ref. 1604 zirkonio bajo demanda
upon request
sur demande



Ref. **1605**

BROCA CORTA PUNTOS SOLDADURA

Welding Point Jobber Drill Bit
Foret courte points soudure



HSSE
8% Co

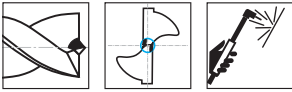

S. Extra-Corta
Stub Series
Série extra-courte

D mm	L mm	I mm	N° Art.	€
8,00	38	15	16328	17,26
8,00	45	15	16329	19,24
10,00	45	15	70687	22,90



Ref. 1605 zirkonio bajo demanda
upon request
sur demande



Ref. **1606**

BROCA FRESA

Milling Drill
Foret à découper la tôle



HSS



D mm	L mm	N° Art.	€
6,00	90	16330	13,70
8,00	95	16331	17,51





Ref. **1610**

BROCA-MACHO-AVELLANADOR

Combi Tap With Countersink
Outil multi-fonction

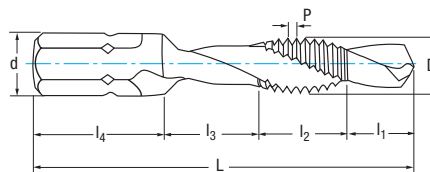

new packaging!

HSS

DIN 3126



Aceros <850 N/mm²
Steel / Aciers

D mm	L mm	l1 mm	l2 mm	l3 mm	l4 mm	d mm	P	Avellanado Countersinking Fraisage mm		Nº Art.	€
M3	36	5	8	7	12	6,35	0,50	7,00	1	12567	17,15
M4	39	5	11	8	12	6,35	0,70	7,00	1	12571	17,15
M5	41	7	11	9	12	6,35	0,80	7,00	1	12577	19,23
M6	44	8	11	10	12	6,35	1,00	7,00	1	10971	19,84
M8	50	11	15	10	12	6,35	1,25	9,00	1	12582	27,42
M10	59	12	21	10	12	6,35	1,50	11,00	1	12583	33,08



Set 7 Pcs

Cont. Ø	Nº Art.	€
M3-M4-M5-M6-M8-M10-Adapt.	11025	133,87



Ref. **1614**

New!



Pag. 336



BROCA-MACHO-AVELLANADOR MANGO E6.3
E6.3 Shank Combi Tap with Countersink
Outil multi-fonction queue E6.3

Línea 33 cm - Ref. 1610



ø	M3	M4	M5	M6	M8
Pcs	2	2	2	2	2

Ref. 4995 - Nº Art. 72199: 201,58 €



FRESAS HUECAS M. ELECTROMAGNÉTICAS
Annular Cutter Core Drills
Fraises à carotter UP électromagnétiques

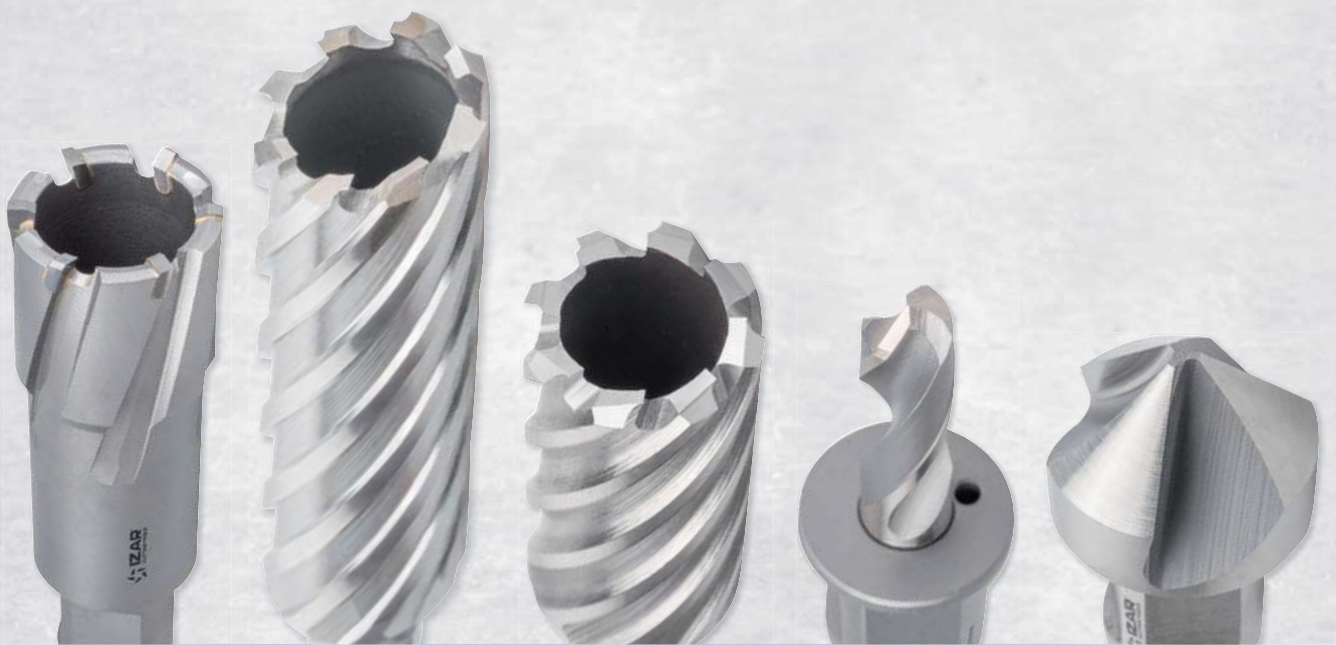

Ref. **4078**

FRESA HUECA MÁQUINAS ELECTROMAGNÉTICAS TCT CORTA

Short TCT Annular Cutter Core Drill

Fraise à carotter pour unité de perçage électromagnétique TCT courte

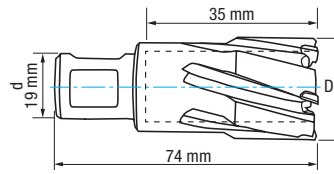

MD/HM
TCT

Serie Corta
Jobber Series
Série courte

Apto con Poca Lubricación
Suitable with Minimal Cooling
Apte avec lubrification minimale

DOBLE
WELDON

Aceros
<850 N/mm²
Steel / Aciers

INOX
Stainless Steel
Acier INOX

Fundición
Cast Iron
Fonte

Cobre
Copper
Cuivre

Latón
Brass
Laiton

Madera
Wood
Bois



D mm	d mm	L mm	I mm	Nº Art.	€	D mm	d mm	L mm	I mm	Nº Art.	€	D mm	d mm	L mm	I mm	Nº Art.	€
14	19	74	35	61963	42,26	30	19	74	35	61980	50,06	46	19	74	35	61996	113,94
15	19	74	35	61964	42,26	31	19	74	35	61981	62,23	47	19	74	35	61997	113,94
16	19	74	35	61965	42,26	32	19	74	35	61982	63,87	48	19	74	35	61998	113,94
17	19	74	35	61966	42,26	33	19	74	35	61983	64,27	49	19	74	35	61999	114,14
18	19	74	35	61967	42,26	34	19	74	35	61984	72,40	50	19	74	35	62000	118,31
19	19	74	35	61968	42,26	35	19	74	35	61985	79,43	51	19	74	35	62001	123,94
20	19	74	35	61969	42,26	36	19	74	35	61986	79,43	52	19	74	35	62002	123,94
21	19	74	35	61970	42,33	37	19	74	35	61987	79,43	53	19	74	35	62003	123,94
22	19	74	35	61971	42,33	38	19	74	35	61988	79,43	54	19	74	35	62004	123,94
23	19	74	35	61973	42,60	39	19	74	35	61989	79,43	55	19	74	35	62005	124,45
24	19	74	35	61974	43,05	40	19	74	35	61990	79,43	56	19	74	35	62006	135,12
25	19	74	35	61975	43,22	41	19	74	35	61991	92,10	57	19	74	35	62007	135,12
26	19	74	35	61976	50,06	42	19	74	35	61992	96,95	58	19	74	35	62008	135,12
27	19	74	35	61977	50,06	43	19	74	35	61993	98,85	59	19	74	35	62009	143,22
28	19	74	35	61978	50,06	44	19	74	35	61994	98,88	60	19	74	35	62010	150,42
29	19	74	35	61979	50,06	45	19	74	35	61995	98,88						

Línea 33 cm - Ref. 4078



∅	14	16	18	20	22
Pcs	2	2	2	2	2

Ref. 4995 - Nº Art. 70967: 422,74 €

Ref. **4075**

EXPULSORES

Pilot Pins
Ejecteurs



D mm	L mm	Cap. mm	Para/For/Pour Ref.	Nº Art.	€
6,34	90	12-17	4078 (35 mm)	65905	17,39
* 6,34	116	12-17	4078 (35 mm)	71750	23,73
7,98	90	18-60	4078 (35 mm)	65907	22,60
* 7,98	118	18-60	4078 (35 mm)	71880	28,48

HSS

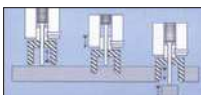

* Para uso con adaptador
When using with adapter / Pour usage avec adaptateur



Ref. **4077**

FRESA HUECA MÁQUINAS ELECTROMAGNÉTICAS TCT LARGA

Long TCT Annular Cutter Core Drill

Fraise à carotter pour unité de perçage électromagnétique TCT longue

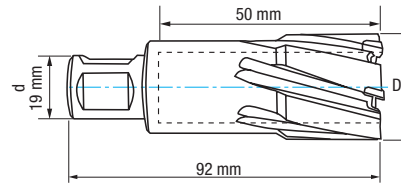

MD/HM
TCT

Serie Larga
Long Length
Série longue

Apto con Poca Lubricación
Suitable with Minimal Cooling
Apte avec lubrification minimale

DOBLE
WELDON

Aceros
<850 N/mm²
Steel / Aciers

INOX
Stainless Steel
Acier INOX

Fundición
Cast Iron
Fonte

Cobre
Copper
Cuivre

Latón
Brass
Laiton

Madera
Wood
Bois



D mm	d mm	L mm	l mm	Nº Art.	€	D mm	d mm	L mm	l mm	Nº Art.	€	D mm	d mm	L mm	l mm	Nº Art.	€
14	19	92	50	56746	60,24	30	19	92	50	56764	75,89	46	19	92	50	56780	147,03
15	19	92	50	56747	60,24	31	19	92	50	56765	91,37	47	19	92	50	56781	147,12
16	19	92	50	56749	60,24	32	19	92	50	56766	91,37	48	19	92	50	56782	147,12
17	19	92	50	56750	60,24	33	19	92	50	56767	91,37	49	19	92	50	56783	147,12
18	19	92	50	56752	60,24	34	19	92	50	56768	91,37	50	19	92	50	56784	147,12
19	19	92	50	56753	60,24	35	19	92	50	56769	91,37	51	19	92	50	56785	166,26
20	19	92	50	56754	60,24	36	19	92	50	56770	104,31	52	19	92	50	56786	166,89
21	19	92	50	56755	63,19	37	19	92	50	56771	104,70	53	19	92	50	56787	166,89
22	19	92	50	56756	63,19	38	19	92	50	56772	104,70	54	19	92	50	56788	166,89
23	19	92	50	56757	63,19	39	19	92	50	56773	104,70	55	19	92	50	56789	166,89
24	19	92	50	56758	63,27	40	19	92	50	56774	104,70	56	19	92	50	56790	183,06
25	19	92	50	56759	63,27	41	19	92	50	56775	126,30	57	19	92	50	56791	183,06
26	19	92	50	56760	75,76	42	19	92	50	56776	126,30	58	19	92	50	56792	183,06
27	19	92	50	56761	75,76	43	19	92	50	56777	126,30	59	19	92	50	56793	194,04
28	19	92	50	56762	75,89	44	19	92	50	56778	126,30	60	19	92	50	56794	199,56
29	19	92	50	56763	75,89	45	19	92	50	56779	126,30						

Línea 33 cm - Ref. 4077



Ø	14	16	18	20	22
Pcs	2	2	2	2	2

Ref. 4995 - Nº Art. 70970: 608,30 €

Ref. **4075**

EXPULSORES

Pilot Pins
Ejecteurs



HSS

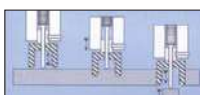

D mm	L mm	Cap. mm	Para/For/Pour Ref.	Nº Art.	€
6,34	106	12-17	4077 (50 mm)	61501	22,05
* 6,34	127	12-17	4077 (50 mm)	71878	18,18
7,98	105	18-60	4077 (50 mm)	61503	26,46
* 7,98	130	18-60	4077 (50 mm)	71883	33,18

* Para uso con adaptador
When using with adapter / Pour usage avec adaptateur



Ref. **4070**

FRESA HUECA MÁQUINAS ELECTROMAGNÉTICAS HSS CORTA

Short HSS Annular Cutter Core Drill

Fraise à carotter pour unité de perçage électromagnétique HSS courte

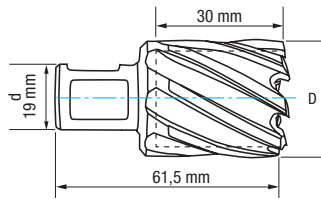

HSS-XT	Serie Corta Jobber Series Série courte	Aceros Construcción Structural Steels Aciers de construction	Apto con Poca Lubricación Suitable with Minimal Cooling Apte avec lubrification minimale	DOBLE WELDON
--------	---	---	---	-----------------

Aceros <850 N/mm ² Steel / Aciers	Aceros <1000 N/mm ² Steel / Aciers	Fundición Cast Iron Fonte
---	--	--



D mm	d mm	L mm	l mm	Nº Art.	€
12	19	61,5	30	21106	25,86
13	19	61,5	30	21107	25,86
14	19	61,5	30	21108	26,81
15	19	61,5	30	21109	27,93
16	19	61,5	30	21110	29,05
17	19	61,5	30	21111	29,98
18	19	61,5	30	21112	31,10
19	19	61,5	30	21113	31,86
20	19	61,5	30	21114	33,35
21	19	61,5	30	21115	35,61
22	19	61,5	30	21116	36,92
23	19	61,5	30	21117	38,43
24	19	61,5	30	21118	39,93
25	19	61,5	30	21119	41,23
26	19	61,5	30	21120	42,73
27	19	61,5	30	21121	43,10
28	19	61,5	30	21122	45,74
29	19	61,5	30	21123	47,24
30	19	61,5	30	21124	48,54
31	19	61,5	30	21125	52,85
32	19	61,5	30	21126	56,60
33	19	61,5	30	21127	59,60
34	19	61,5	30	21128	68,00
35	19	61,5	30	21129	75,26
36	19	61,5	30	21130	75,50

D mm	d mm	L mm	l mm	Nº Art.	€
37	19	61,5	30	21131	76,86
38	19	61,5	30	21132	77,62
39	19	61,5	30	21133	78,34
40	19	61,5	30	21134	78,64
41	19	61,5	30	21135	80,50
42	19	61,5	30	21136	85,83
43	19	61,5	30	21137	89,74
44	19	61,5	30	21138	92,60
45	19	61,5	30	21139	93,67
46	19	61,5	30	21140	95,77
47	19	61,5	30	21141	97,56
48	19	61,5	30	21142	101,50
49	19	61,5	30	21143	102,21
50	19	61,5	30	21144	108,25
51	19	61,5	30	21145	110,39
52	19	61,5	30	21146	113,95
53	19	61,5	30	21147	116,57
54	19	61,5	30	21148	122,43
55	19	61,5	30	21149	124,16
56	19	61,5	30	21150	128,28
57	19	61,5	30	21151	132,43
58	19	61,5	30	21152	134,50
59	19	61,5	30	21153	142,08
60	19	61,5	30	21154	150,41



Set 6 Pcs

Cont. Ø	Nº Art.	€
12-14-16-18-20-22	66858	183,09



Set 5 Pcs

Cont. Ø	Nº Art.	€
24-26-28-30-32	66859	233,54

Línea 33 cm - Ref. 4070



Ø	14	16	18	20	22
Pcs	2	2	2	2	2

Ref. 4995 - Nº Art. 70974: 314,46 €

Ref. **4075**

EXPULSORES

Pilot Pins
Ejecteurs



HSS



D mm	L mm	Para/For/Pour Ref.	Nº Art.	€
6,34	77	4070 (30 mm)	61502	9,39
* 6,34	102	4070 (30 mm)	61500	12,96

* Para uso con adaptador
When using with adapter
Pour usage avec adaptateur





Ref. **4071**

FRESA HUECA MÁQUINAS ELECTROMAGNÉTICAS HSS LARGA

Long HSS Annular Cutter Core Drill

Fraise à carotter pour unité de perçage électromagnétique HSS longue

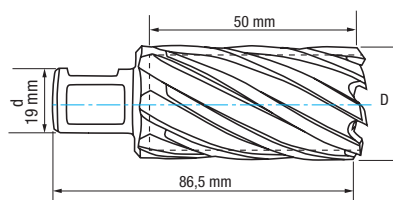

HSS-XT	Serie Larga Long Length Série longue	Aceros Construcción Structural Steels Aciers de construction	Apto con Poca Lubricación Suitable with Minimal Cooling Apte avec lubrification minimale	Rectificado Ground Taillé meulé	DOBLE WELDON
--------	---	---	---	--	-----------------

Aceros <850 N/mm ² Steel / Aciers	Aceros <1000 N/mm ² Steel / Aciers	Fundición Cast Iron Fonte	Aluminio Aluminium
---	--	--	------------------------------



D mm	d mm	L mm	l mm	Nº Art.	€	D mm	d mm	L mm	l mm	Nº Art.	€	D mm	d mm	L mm	l mm	Nº Art.	€
12	19	86,5	50	73338	35,82	28	19	86,5	50	21171	68,22	45	19	86,5	50	21189	117,13
13	19	86,5	50	73339	35,82	29	19	86,5	50	21172	70,83	46	19	86,5	50	21190	118,53
14	19	86,5	50	21157	37,13	30	19	86,5	50	21173	71,65	47	19	86,5	50	21191	125,15
15	19	86,5	50	21158	38,62	31	19	86,5	50	21174	75,26	48	19	86,5	50	21192	128,28
16	19	86,5	50	21159	41,23	32	19	86,5	50	21175	78,55	49	19	86,5	50	21193	128,98
17	19	86,5	50	21160	42,73	33	19	86,5	50	21177	82,19	50	19	86,5	50	21194	131,77
18	19	86,5	50	21161	45,93	34	19	86,5	50	21178	85,82	51	19	86,5	50	21195	139,44
19	19	86,5	50	21162	46,85	35	19	86,5	50	21179	89,45	52	19	86,5	50	21196	145,02
20	19	86,5	50	21163	48,18	36	19	86,5	50	21180	92,00	53	19	86,5	50	21197	162,43
21	19	86,5	50	21164	53,60	37	19	86,5	50	21181	95,45	54	19	86,5	50	21198	164,84
22	19	86,5	50	21165	55,11	38	19	86,5	50	21182	98,18	55	19	86,5	50	21199	166,42
23	19	86,5	50	21166	56,98	39	19	86,5	50	21183	101,09	56	19	86,5	50	21200	171,40
24	19	86,5	50	21167	58,67	40	19	86,5	50	21184	106,33	57	19	86,5	50	21201	182,11
25	19	86,5	50	21168	60,35	41	19	86,5	50	21185	108,07	58	19	86,5	50	21202	182,15
26	19	86,5	50	21169	62,23	42	19	86,5	50	21186	109,47	59	19	86,5	50	21203	192,50
27	19	86,5	50	21170	65,22	43	19	86,5	50	21187	112,26	60	19	86,5	50	21204	199,53
						44	19	86,5	50	21188	113,65						

Línea 33 cm - Ref. 4071



∅	14	16	18	20	22
Pcs	2	2	2	2	2

Ref. 4995 - Nº Art. 70978: 455,16 €

Ref. **4075**

EXPULSORES

Pilot Pins

Ejecteurs



HSS

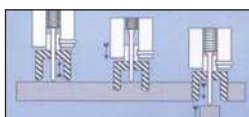

D mm	L mm	Para/For/Pour Ref.	Nº Art.	€
6,34	102	4071 (50 mm)	61500	12,96
* 6,34	127	4071 (50 mm)	71878	18,18

* Para uso con adaptador
When using with adapter / Pour usage avec adaptateur



Ref. **4072**

FRESA HUECA MÁQUINAS ELECTROMAGNÉTICAS HSS EXTRA LARGA

Extra Long HSS Annular Cutter Core Drill

Fraise à carotter pour unité de perçage électromagnétique HSS extra-longue

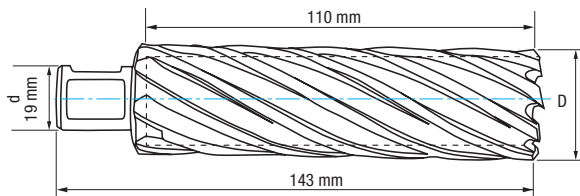

HSS-XT	Serie Extra-Larga Extra-Long Series Série extra-longue	Aceros Construcción Structural Steels Aciers de construction	Apto con Poca Lubricación Suitable with Minimal Cooling Apte avec lubrification minimale	DOBLE WELDON
--------	--	--	--	-----------------

Aceros <850 N/mm ² Steel / Aciers	Aceros <1000 N/mm ² Steel / Aciers	Fundición Cast Iron Fonte	Aluminio Aluminium
--	---	---------------------------------	-----------------------



D mm	d mm	L mm	I mm	Nº Art.	€	D mm	d mm	L mm	I mm	Nº Art.	€	D mm	d mm	L mm	I mm	Nº Art.	€
20	19	143	110	56694	96,17	31	19	143	110	56706	136,40	42	19	143	110	56718	201,69
21	19	143	110	56695	97,99	32	19	143	110	56707	138,81	43	19	143	110	56719	205,09
22	19	143	110	56696	99,84	33	19	143	110	56708	148,63	44	19	143	110	56721	208,57
23	19	143	110	56697	101,82	34	19	143	110	56709	151,32	45	19	143	110	56722	251,41
24	19	143	110	56698	107,88	35	19	143	110	56710	154,09	46	19	143	110	56724	254,82
25	19	143	110	56699	109,86	36	19	143	110	56711	156,94	47	19	143	110	56725	258,40
26	19	143	110	56700	121,30	37	19	143	110	56712	160,20	48	19	143	110	56727	261,86
27	19	143	110	56701	123,50	38	19	143	110	56714	163,21	49	19	143	110	56728	265,42
28	19	143	110	56702	125,93	39	19	143	110	56715	166,29	50	19	143	110	56730	269,04
29	19	143	110	56703	128,29	40	19	143	110	56716	169,46						
30	19	143	110	56704	130,74	41	19	143	110	56717	198,37						

Línea 33 cm - Ref. 4072



∅	20	22	26	32	40
Pcs	1	1	1	1	1

Ref. 4995 - Nº Art. 72090: 625,58 €

Ref. **4075**

EXPULSORES

Pilot Pins

Ejecteurs



HSS

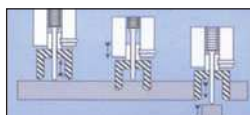

D mm	L mm	Para/For/Pour Ref.	Nº Art.	€
7,98	154	4072 (110 mm)	61504	22,95
* 7,98	180	4072 (110 mm)	71885	34,73

* Para uso con adaptador
When using with adapter
Pour usage avec adaptateur





Ref. **4079**

BROCA MÁQUINAS ELECTROMAGNÉTICAS HSS

HSS Solid Drill

Foret pour unité de perçage électromagnétique HSS

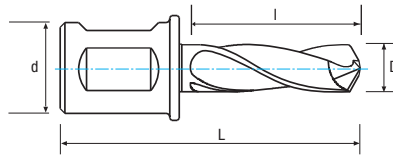

HSS-XT	Serie Corta Jobber Series Série courte	Aceros Construcción Structural Steels Aciers de construction	Apto con Poca Lubricación Suitable with Minimal Cooling Apte avec lubrification minimale	DOBLE WELDON
---------------	---	---	---	---------------------

Aceros <850 N/mm² Steel / Aciers	Aceros <1000 N/mm² Steel / Aciers	Fundición Cast Iron Fonte
--	---	--

D mm	d mm	L mm	l mm	Nº Art.	€
6	19	63	25	69758	24,89
8	19	63	25	69761	24,89
10	19	63	25	69763	25,86
12	19	63	25	69768	28,74
14	19	63	25	69769	29,79



Línea 33 cm - Ref. 4079



∅	6	8	10	12	14
Pcs	1	1	1	1	1

Ref. 4995 - Nº Art. 70982: 134,17 €



Ref. **4076**

AVELLANADOR MÁQUINA ELECTROMAGNÉTICA

Annular Cutter Core Drill Countersink

Fraise à noyer pour unité de perçage électromagnétique



HSS-XT



3 Z

DOBLE
WELDON

Aceros
<850 N/mm²
Steel / Aciers

INOX
Stainless Steel
Acier INOX

Fundición
Cast Iron
Fonte

Cobre
Copper
Cuivre

Latón
Brass
Laiton

Madera
Wood
Bois

D+ mm	D- mm	d mm	L mm	Nº Art.	€
25	3	19	45	61505	119,89
30	3	19	47	61506	120,52
40	3	19	52	61507	139,70
50	3	19	57	61508	159,03
55	3	19	60	61509	177,87



Línea 33 cm - Ref. 4076



∅	25	30	40	50	55
Pcs	1	1	1	1	1

Ref. 4995 - Nº Art. 72093: **717,01 €**





Ref. **4074**

ADAPTADOR FRESA HUECA MÁQUINA ELECTROMAGNÉTICA

Annular Cutter Core Drill Adaptor

Adaptateur pour fraise à carotter pour unité de perçage électromagnétique



Fresa Cutter Fraise	Máquina Machine	Expulsor mm Pilot Pin Ejecteur	L mm	I mm	Nº Art.	€
Doble Weldon	Fein Quick In	6,35	51,20	28,60	61510	29,35
Doble Weldon	Fein Quick In	7,98	51,20	28,60	61511	29,35



Fresa Cutter Fraise	Máquina Machine	Expulsor mm Pilot Pin Ejecteur	L mm	I mm	Nº Art.	€
Doble Weldon	Universal	6,35	51,20	28,60	61512	28,78
Doble Weldon	Universal	7,98	51,20	28,60	61513	28,78



Entrada In Entrée	Salida Out Sortie	L mm	Nº Art.	€
Doble Weldon	1/2×20h	43	83450	29,93



Entrada In Entrée	Salida Out Sortie	L mm	Nº Art.	€
Doble Weldon	B16	57	83449	29,93

Ref. **4073**

CONO PORTA FRESAS HUECAS

Holder for annular cutters

Cône pour porte-fraise à carotter pour unité de perçage électromagnétique

New!

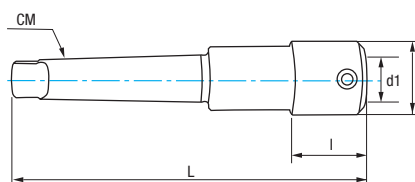

CM	D mm	L mm	I mm	d1 mm	Nº Art.	€
2	37	165	37	19	84115	69,24
3	37	175	37	19	84116	74,32

Llave Allen incluida

Allen key included







Clé Allen incluse



ELECCIÓN ADAPTADORES FRESAS HUECAS DOBLE WELDON

Double Weldon Annular Cutter Core Drill Adaptor Choice

Choix d'adaptateurs pour fraises à carotter Double Weldon

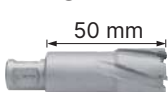
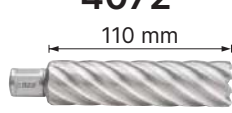
Ref. 4075		Ref. 4074		Ref. 4075	
Fresa Cutter Fraise	Expulsor sin Adaptador Pilot Pin without adapter Ejecteur sans adaptateur	Adaptador Máquina Adaptor Machine Adaptateur machine	FEIN QUICK IN	* Expulsor para uso con adaptador * Pilot Pin when using with Adapter * Ejecteur pour usage avec adaptateur	
4078 	(12-17 mm) 6,34 × 90 mm. Art. 65905	 Art. 61510		(12-17 mm) * 6,34 × 116 mm. Art. 71750	
4077 	(12-17 mm) 6,34 × 106 mm. Art. 61501			(12-17 mm) * 6,34 × 127 mm. Art. 71878	
4070 	6,34 × 77 mm. Art. 61502			* 6,34 × 102 mm. Art. 61500	
4071 	6,34 × 102 mm. Art. 61500			* 6,34 × 127 mm. Art. 71878	
4078 	(18-60 mm) 7,98 × 90 mm. Art. 65907			 Art. 61511	
4077 	(18-60 mm) 7,98 × 105 mm. Art. 61503	(18-60 mm) * 7,98 × 130 mm. Art. 71883			
4072 	7,98 × 154 mm. Art. 61504	* 7,98 × 180 mm. Art. 71885			









ELECCIÓN ADAPTADORES FRESAS HUECAS DOBLE WELDON

Double Weldon Annular Cutter Core Drill Adaptor Choice

Choix d'adaptateurs pour fraises à carotter Double Weldon

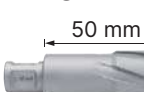
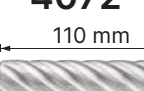

Ref. 4075		Ref. 4074		Ref. 4075	
Fresa Cutter Fraise	Expulsor sin Adaptador Pilot Pin without adapter Ejecteur sans adaptateur	Adaptador Máquina Adaptor Machine Adaptateur machine	UNIVERSAL Nitto + Weldon	* Expulsor para uso con adaptador * Pilot Pin when using with Adapter * Ejecteur pour usage avec adaptateur	
4078 	(12-17 mm) 6,34 × 90 mm. Art. 65905	 Art. 61512		(12-17 mm) * 6,34 × 116 mm. Art. 71750	
4077 	(12-17 mm) 6,34 × 106 mm. Art. 61501			(12-17 mm) * 6,34 × 127 mm. Art. 71878	
4070 	6,34 × 77 mm. Art. 61502			* 6,34 × 102 mm. Art. 61500	
4071 	6,34 × 102 mm. Art. 61500			* 6,34 × 127 mm. Art. 71878	
4078 	(18-60 mm) 7,98 × 90 mm. Art. 65907			(18-60 mm) * 7,98 × 118 mm. Art. 71880	
4077 	(18-60 mm) 7,98 × 105 mm. Art. 61503			(18-60 mm) * 7,98 × 130 mm. Art. 71883	
4072 	7,98 × 154 mm. Art. 61504			* 7,98 × 180 mm. Art. 71885	



Ref. **4067**

FRESA HUECA MÁQUINAS ELECTROMAGNÉTICAS TCT LARGA

Long TCT Annular Cutter Core Drill

Fraise à carotter pour unité de perçage électromagnétique TCT longue

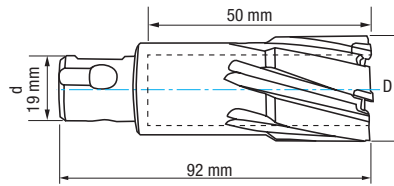

MD/HM
TCT

Serie Larga
Long Length
Série longue

Apto con Poca Lubricación
Suitable with Minimal Cooling
Apte avec lubrification minimale

UNIVERSAL:
NITTO +
WELDON

Aceros
<850 N/mm²
Steel / Aciers

INOX
Stainless Steel
Acier INOX

Fundición
Cast Iron
Fonte

Cobre
Copper
Cuivre

Latón
Brass
Laiton

Madera
Wood
Bois



D mm	d mm	L mm	l mm	Nº Art.	€	D mm	d mm	L mm	l mm	Nº Art.	€	D mm	d mm	L mm	l mm	Nº Art.	€
14	19	92	50	61248	60,24	30	19	92	50	61264	75,89	46	19	92	50	61280	147,03
15	19	92	50	61249	60,24	31	19	92	50	61265	91,37	47	19	92	50	61281	147,12
16	19	92	50	61250	60,24	32	19	92	50	61266	91,37	48	19	92	50	61282	147,12
17	19	92	50	61251	60,24	33	19	92	50	61267	91,37	49	19	92	50	61283	147,12
18	19	92	50	61252	60,24	34	19	92	50	61268	91,37	50	19	92	50	61199	147,12
19	19	92	50	61253	60,24	35	19	92	50	61269	91,37	51	19	92	50	61284	166,26
20	19	92	50	61254	60,24	36	19	92	50	61270	104,31	52	19	92	50	61285	166,89
21	19	92	50	61255	63,19	37	19	92	50	61271	104,70	53	19	92	50	61286	166,89
22	19	92	50	61256	63,19	38	19	92	50	61272	104,70	54	19	92	50	61287	166,89
23	19	92	50	61257	63,19	39	19	92	50	61273	104,70	55	19	92	50	61288	166,89
24	19	92	50	61258	63,27	40	19	92	50	61274	104,70	56	19	92	50	61289	183,06
25	19	92	50	61259	63,27	41	19	92	50	61275	126,30	57	19	92	50	61290	183,06
26	19	92	50	61260	75,76	42	19	92	50	61276	126,30	58	19	92	50	61291	183,06
27	19	92	50	61261	75,76	43	19	92	50	61277	126,30	59	19	92	50	61292	194,04
28	19	92	50	61262	75,89	44	19	92	50	61278	126,30	60	19	92	50	61293	199,56
29	19	92	50	61263	75,89	45	19	92	50	61279	126,30						

Línea 33 cm - Ref. 4067



∅	14	16	18	20	22
Pcs	2	2	2	2	2

Ref. 4995 - Nº Art. 72096: 608,30 €

Ref. **4075**

EXPULSORES

Pilot Pins

Ejecteurs



HSS

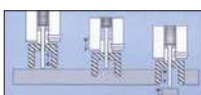

D mm	L mm	Cap. mm	Para/For/Pour Ref.	Nº Art.	€
6,34	106	12-17	4067 (50 mm)	61501	22,05
7,98	105	18-60	4067 (50 mm)	61503	26,46



Ref. **4060**

FRESA HUECA MÁQUINAS ELECTROMAGNÉTICAS HSS CORTA

Short HSS Annular Cutter Core Drill

Fraise à carotter pour unité de perçage électromagnétique HSS courte

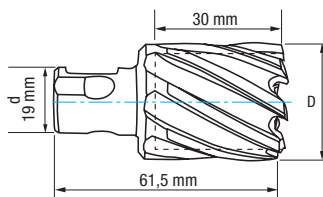

HSS-XT	Serie Corta Jobber Series Série courte	Aceros Construcción Structural Steels Aciers de construction	Apto con Poca Lubricación Suitable with Minimal Cooling Apte avec lubrification minimale	UNIVERSAL: NITTO + WELDON
--------	---	---	---	---------------------------------

Aceros <850 N/mm ² Steel / Aciers	Aceros <1000 N/mm ² Steel / Aciers	Fundición Cast Iron Fonte	Aluminio Aluminium
---	--	--	------------------------------



D mm	d mm	L mm	l mm	Nº Art.	€	D mm	d mm	L mm	l mm	Nº Art.	€
12	19	61,5	30	61120	25,86	37	19	61,5	30	61145	76,86
13	19	61,5	30	61121	25,86	38	19	61,5	30	61146	77,62
14	19	61,5	30	61122	26,81	39	19	61,5	30	61147	78,34
15	19	61,5	30	61123	27,93	40	19	61,5	30	61148	78,64
16	19	61,5	30	61124	29,05	41	19	61,5	30	61149	80,50
17	19	61,5	30	61125	29,98	42	19	61,5	30	61150	85,83
18	19	61,5	30	61126	31,10	43	19	61,5	30	61151	89,74
19	19	61,5	30	61127	31,86	44	19	61,5	30	61152	92,60
20	19	61,5	30	61128	33,35	45	19	61,5	30	61153	93,67
21	19	61,5	30	61129	35,61	46	19	61,5	30	61154	95,77
22	19	61,5	30	61130	36,92	47	19	61,5	30	61155	97,56
23	19	61,5	30	61131	38,43	48	19	61,5	30	61156	101,50
24	19	61,5	30	61132	39,93	49	19	61,5	30	61157	102,21
25	19	61,5	30	61133	41,23	50	19	61,5	30	61158	108,25
26	19	61,5	30	61134	42,73	51	19	61,5	30	61159	110,39
27	19	61,5	30	61135	43,10	52	19	61,5	30	61160	113,95
28	19	61,5	30	61136	45,74	53	19	61,5	30	61161	116,57
29	19	61,5	30	61137	47,24	54	19	61,5	30	61162	122,43
30	19	61,5	30	61138	48,54	55	19	61,5	30	61163	124,16
31	19	61,5	30	61139	52,85	56	19	61,5	30	61164	128,28
32	19	61,5	30	61140	56,60	57	19	61,5	30	61165	132,43
33	19	61,5	30	61141	59,60	58	19	61,5	30	61166	134,50
34	19	61,5	30	61142	68,00	59	19	61,5	30	61167	142,08
35	19	61,5	30	61143	75,26	60	19	61,5	30	61168	150,41
36	19	61,5	30	61144	75,50						



Set 6 Pcs

Cont. Ø	Nº Art.	€
12-14-16-18-20-22	66860	183,09



Set 5 Pcs

Cont. Ø	Nº Art.	€
24-26-28-30-32	66861	233,54

Línea 33 cm - Ref. 4060



Ø	14	16	18	20	22
Pcs	2	2	2	2	2

Ref. 4995 - Nº Art. 72099: **314,46 €**

Ref. **4075**

EXPULSORES

Pilot Pins
Ejecteurs

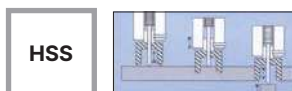

D mm	L mm	Para/For/Pour Ref.	Nº Art.	€
6,34	77	4060 (30 mm)	61502	9,39



Ref. **4061**

FRESA HUECA MÁQUINAS ELECTROMAGNÉTICAS HSS LARGA

Long HSS Annular Cutter Core Drill

Fraise à carotter pour unité de perçage électromagnétique HSS longue

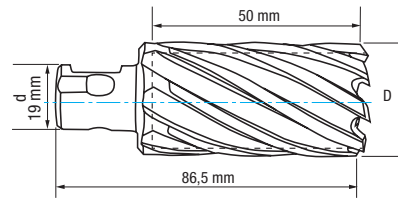

HSS-XT	Serie Larga Long Length Série longue	Aceros Construcción Structural Steels Aciers de construction	Apto con Poca Lubricación Suitable with Minimal Cooling Apte avec lubrification minimale	Rectificado Ground Taillé meulé	UNIVERSAL: NITTO + WELDON
--------	---	---	---	--	--

Aceros <850 N/mm ² Steel / Aciers	Aceros <1000 N/mm ² Steel / Aciers	Fundición Cast Iron Fonte	Aluminio Aluminium
---	--	--	------------------------------



D mm	d mm	L mm	I mm	Nº Art.	€	D mm	d mm	L mm	I mm	Nº Art.	€	D mm	d mm	L mm	I mm	Nº Art.	€
12	19	86,5	50	73340	35,82	28	19	86,5	50	61183	68,22	45	19	86,5	50	61201	117,13
13	19	86,5	50	73342	35,82	29	19	86,5	50	61184	70,83	46	19	86,5	50	61202	118,53
14	19	86,5	50	61169	37,13	30	19	86,5	50	61185	71,65	47	19	86,5	50	61203	125,15
15	19	86,5	50	61170	38,62	31	19	86,5	50	61186	75,26	48	19	86,5	50	61204	128,28
16	19	86,5	50	61171	41,23	32	19	86,5	50	61187	78,55	49	19	86,5	50	61205	128,98
17	19	86,5	50	61172	42,73	33	19	86,5	50	61188	82,19	50	19	86,5	50	61206	131,77
18	19	86,5	50	61173	45,93	34	19	86,5	50	61189	85,82	51	19	86,5	50	61207	139,44
19	19	86,5	50	61174	46,85	35	19	86,5	50	61190	89,45	52	19	86,5	50	61208	145,02
20	19	86,5	50	61175	48,18	36	19	86,5	50	61191	92,00	53	19	86,5	50	61209	162,43
21	19	86,5	50	61176	53,60	37	19	86,5	50	61192	95,45	54	19	86,5	50	61210	164,84
22	19	86,5	50	61177	55,11	38	19	86,5	50	61193	98,18	55	19	86,5	50	61211	166,42
23	19	86,5	50	61178	56,98	39	19	86,5	50	61194	101,09	56	19	86,5	50	61212	171,40
24	19	86,5	50	61179	58,67	40	19	86,5	50	61195	106,33	57	19	86,5	50	61213	182,11
25	19	86,5	50	61180	60,35	41	19	86,5	50	61196	108,07	58	19	86,5	50	61214	182,15
26	19	86,5	50	61181	62,23	42	19	86,5	50	61197	109,47	59	19	86,5	50	61215	192,50
27	19	86,5	50	61182	65,22	43	19	86,5	50	61198	112,26	60	19	86,5	50	61216	199,53
						44	19	86,5	50	61200	113,65						

Línea 33 cm - Ref. 4061

∅	14	16	18	20	22
Pcs	2	2	2	2	2

Ref. 4995 - Nº Art. 72105: 455,16 €

Ref. **4075**

EXPULSORES

Pilot Pins
Ejecteurs



HSS

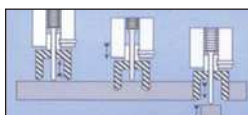

D mm	L mm	Para/For/Pour Ref.	Nº Art.	€
6,34	102	4061 (50 mm)	61500	12,96



Ref. **4062**

FRESA HUECA MÁQUINAS ELECTROMAGNÉTICAS HSS EXTRA LARGA

Extra Long HSS Annular Cutter Core Drill

Fraise à carotter pour unité de perçage électromagnétique HSS extra-longue

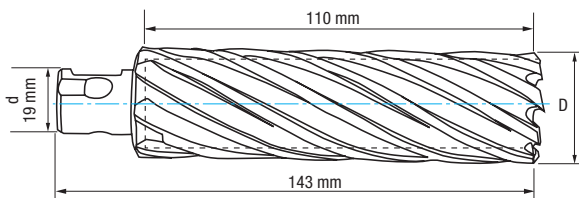

HSS-XT	Serie Extra-Larga Extra-Long Series Série extra-longue	Aceros Construcción Structural Steels Aciers de construction	Apto con Poca Lubricación Suitable with Minimal Cooling Apte avec lubrification minimale	UNIVERSAL: NITTO + WELDON
---------------	---	---	---	--

Aceros <850 N/mm ² Steel / Aciers	Aceros <1000 N/mm ² Steel / Aciers	Fundición Cast Iron Fonte	Aluminio Aluminium
---	--	--	------------------------------



D mm	d mm	L mm	I mm	Nº Art.	€	D mm	d mm	L mm	I mm	Nº Art.	€	D mm	d mm	L mm	I mm	Nº Art.	€
20	19	143	110	61217	96,17	31	19	143	110	61228	136,40	42	19	143	110	61239	201,69
21	19	143	110	61218	97,99	32	19	143	110	61229	138,81	43	19	143	110	61240	205,09
22	19	143	110	61219	99,84	33	19	143	110	61230	148,63	44	19	143	110	61241	208,57
23	19	143	110	61220	101,82	34	19	143	110	61231	151,32	45	19	143	110	61242	251,41
24	19	143	110	61221	107,88	35	19	143	110	61232	154,09	46	19	143	110	61243	254,82
25	19	143	110	61222	109,86	36	19	143	110	61233	156,94	47	19	143	110	61244	258,40
26	19	143	110	61223	121,30	37	19	143	110	61234	160,20	48	19	143	110	61245	261,86
27	19	143	110	61224	123,50	38	19	143	110	61235	163,21	49	19	143	110	61246	265,42
28	19	143	110	61225	125,93	39	19	143	110	61236	166,29	50	19	143	110	61247	269,04
29	19	143	110	61226	128,29	40	19	143	110	61237	169,46						
30	19	143	110	61227	130,74	41	19	143	110	61238	198,37						

Línea 33 cm - Ref. 4062



25 cm

∅	20	22	26	32	40
Pcs	1	1	1	1	1

Ref. 4995 - Nº Art. 72108: 625,58 €

Ref. **4075**

EXPULSORES

Pilot Pins

Ejecteurs

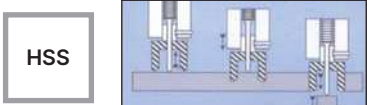

HSS	D mm	L mm	Para/For/Pour Ref.	Nº Art.	€
	7,98	154	4062 (110 mm)	61504	22,95



CORONAS

Hole Saws

Trépan

Ref. **1667**

CORONA REAFILABLE HSS

HSS Resharpenable Hole Saw

Fraise réaffûtable HSS

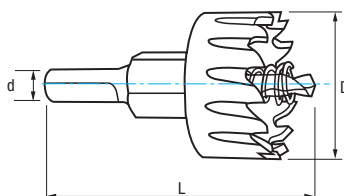

HSS



Aceros
<850 N/mm²
Steel / Aciers

Fundición
Cast Iron
Fonte

Cobre
Copper
Cuivre

Latón
Brass
Laiton

Aluminio
Aluminium

Madera
Wood
Bois



D mm	d mm	L mm	D mm Broca Drill Bit Foret	Nº Art.	€	D mm	d mm	L mm	D mm Broca Drill Bit Foret	Nº Art.	€	D mm	d mm	L mm	D mm Broca Drill Bit Foret	Nº Art.	€
12	10	75,50	6	56569	17,84	33	10	75,50	6	56590	36,54	76	10	75,50	6	68608	132,21
13	10	75,50	6	56570	17,84	35	10	75,50	6	56160	37,74	80	10	75,50	6	56603	132,21
14	10	75,50	6	56572	17,84	36	10	75,50	6	56591	40,11	85	10	75,50	6	56605	139,33
15	10	75,50	6	56573	17,84	38	10	75,50	6	56593	41,98	90	10	75,50	6	56606	154,07
16	10	75,50	6	56152	17,84	39	10	75,50	6	56594	43,18	100	10	75,50	6	56608	168,80
17	10	75,50	6	56576	19,14	40	10	75,50	6	56161	44,37						
18	10	75,50	6	56578	20,53	42	10	75,50	6	56596	46,68						
19	10	75,50	6	56579	21,71	45	10	75,50	6	56597	50,28						
20	10	75,50	6	56154	22,91	48	10	75,50	6	56163	52,81						
21	10	75,50	6	56582	22,91	49	10	75,50	6	68602	54,80						
22	10	75,50	6	56155	24,09	50	10	75,50	6	56164	55,20						
23	10	75,50	6	56583	25,28	51	10	75,50	6	68604	67,25						
24	10	75,50	6	56584	26,62	53	10	75,50	6	56599	67,25						
25	10	75,50	6	56156	27,81	55	10	75,50	6	56600	68,59						
26	10	75,50	6	56585	28,99	60	10	75,50	6	56165	75,29						
27	10	75,50	6	56157	30,19	63	10	75,50	6	68605	91,37						
28	10	75,50	6	56587	31,79	65	10	75,50	6	56602	91,37						
29	10	75,50	6	56588	32,97	68	10	75,50	6	68607	105,46						
30	10	75,50	6	56158	32,97	70	10	75,50	6	56166	105,46						
32	10	75,50	6	56159	35,36	75	10	75,50	6	56167	113,51						

* Broca y muelle incluidos
Drill Bit & Spring included
Foret et ressort inclus



Set 6 Pcs

Cont. Ø	Nº Art.	€
12-14-16-18-20-22	77448	121,05

TIN

Bajo demanda / upon request / sur demande

Ref. **1664**



Broca / Drill Bit / Foret

D mm	L mm	Cap.	Nº Art.	€ 1 ud.
5	48	12-15	83478	3,72
6	48	16-100	60704	3,92



Muelle / Spring / Ressort

D mm	L mm	Box	Nº Art.	€ pack
8,5	20	10	60637	0,90
8,5	35	10	60638	0,92



Expo - Ref. 1667

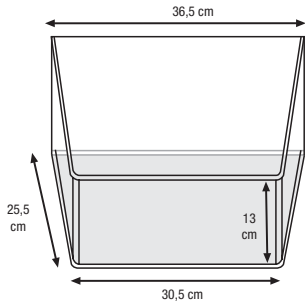

31 Pcs

N° Art.	€
66804	1.032,73

Diam.	N° Art.	Uds.	Diam.	N° Art.	Uds.
12	56569	1	28	56587	1
13	56570	1	29	56588	1
14	56572	1	30	56158	1
15	56573	1	32	56159	1
16	56152	1	33	56590	1
17	56576	1	35	56160	1
18	56578	1	36	56591	1
19	56579	1	38	56593	1
20	56154	1	39	56594	1
21	56582	1	40	56161	1
22	56155	1	42	56596	1
23	56583	1	45	56597	1
24	56584	1	48	56163	1
25	56156	1	50	56164	1
26	56585	1	65	56602	1
27	56157	1			

Línea 1 m - Ref. 1667



∅	16	19	20	22	24	25	27	29	30	32	35	51	63	65
Pcs	1	1	1	1	1	1	1	1	1	1	1	1	1	1

Ref. 4995 - N° Art. 72109: 560,20 €

Display 65 - Ref. 1667



∅	16	18	20	22	24	25	27	32
Pcs	1	1	1	1	1	1	1	1

Ref. 4995 - N° Art. 70083: 205,35 €

Ref. **1663**

CORONA INOX ALTO RENDIMIENTO

TCT High Performance STAINLESS Hole Saw
Trépan INOX haut rendement

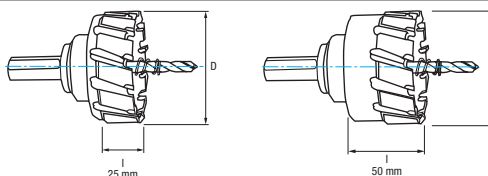

Husillo incluido
Included Spindle
Arbre compris

Broca incluida
Included Center Drill
Foret compris

Cono Morse opcional
Optional Morse Taper
Cône Morse optionel

Diente MD
Carbide Tipped
Dent carbure

PVC

Fibra Vidrio
Fiberglass
Fibre de verre

Aceros
<850 N/mm²
Steel / Aciers

Plásticos
Plastics
Plastiques

INOX
Stainless Steel
Acier INOX

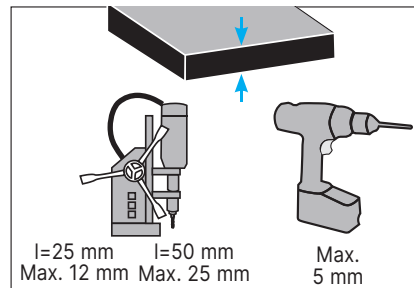
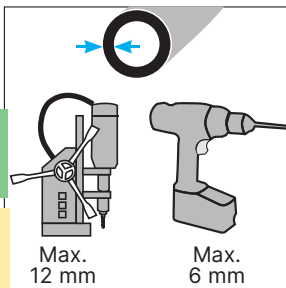

D mm	I mm	d mm	Nº Art.	€
14	25	13	71756	78,71
15	25	13	71758	78,71
16	25	13	71760	78,71
17	25	13	71761	78,71
18	25	13	71762	79,00
19	25	13	71763	78,71
20	25	13	71764	80,20
21	25	13	71765	82,79
22	25	13	71768	82,79
23	25	13	71769	83,98
24	25	13	71770	83,98
25	25	13	71771	83,98
26	25	13	71772	85,35
27	25	13	71773	86,74
28	25	13	71774	86,74
29	25	13	71775	86,74
30	25	13	71776	86,74
31	25	13	71777	97,95
32	25	13	71780	101,47
33	25	13	71781	101,47
34	25	13	71782	102,58
35	25	13	71783	102,58
36	25	13	71784	114,93
37	25	13	71785	114,93

D mm	I mm	d mm	Nº Art.	€
38	25	13	71787	117,80
39	25	13	71788	117,80
40	25	13	71789	119,03
41	25	13	71790	129,46
42	25	13	71791	141,00
43	25	13	71792	141,00
44	25	13	71793	141,00
45	25	13	71794	145,00
46	25	13	71795	147,67
47	25	13	71796	147,67
48	25	13	71797	147,67
49	25	13	71798	147,67
50	25	13	71799	150,00
51	25	13	71800	174,72
52	25	13	71801	174,72
53	25	13	71802	175,96
54	25	13	71803	175,96
55	25	13	71804	175,96
56	25	13	71805	195,43
57	25	13	71806	195,43
58	25	13	71807	195,43
59	25	13	71808	195,43
60	25	13	71809	195,43

D mm	I mm	d mm	Nº Art.	€
18	50	13	71952	90,84
20	50	13	71953	92,24
22	50	13	71955	95,21
25	50	13	71956	96,58
30	50	13	71957	99,76
35	50	13	71958	112,85
40	50	13	71959	130,92
45	50	13	71960	159,51
50	50	13	71961	165,01
55	50	13	71962	193,55
60	50	13	71963	214,98
65	50	13	71810	230,51
68	50	13	71964	248,77
70	50	13	71811	248,77
75	50	13	71812	252,07
80	50	13	71814	260,93
85	50	13	71815	270,33
90	50	13	71817	276,86
95	50	13	71818	277,36
100	50	13	71819	281,10
105	50	13	71965	296,59
110	50	13	71966	329,41
115	50	13	71967	365,12
120	50	13	71968	404,07
125	50	13	71970	432,27

Ref. **1659**

ACCESORIOS / Accessories / Accessoires



Broca Centrar *
Center Drill / Foret à centrer



Para Corona	Cap.	D	L	I	Nº	€
For Hole Saw	mm	mm	mm	mm	Art.	
Pour Trépan						
I mm						
25	14-60	6	80	30	71982	13,58
25	61-125	8	80	30	71983	14,88
50	14-60	6	110	55	71985	19,63
50	61-125	8	110	55	71986	23,99

Husillo 3 Planos *
3-Flat Spindle / Arbre 3 plans



Cap.	L	Nº	€
mm	mm	Art.	
14-60	53	71977	21,34
61-100	53	71979	21,34
101-125	57	71980	34,27

Cono Morse **
Morse Taper / Cône Morse



CM	Cap.	L	Nº	€
	mm	mm	Art.	
2	16-100	108,5	71988	64,71
3	101-125	133	71989	85,98

* Repuesto incluido / Included Spare / Rechange compris

** Accesorio opcional / Optional Accessory / Accessoire optionel



Ref. **1665**

CORONA INOX
TCT **STAINLESS** Hole Saw
Trépan **INOX**

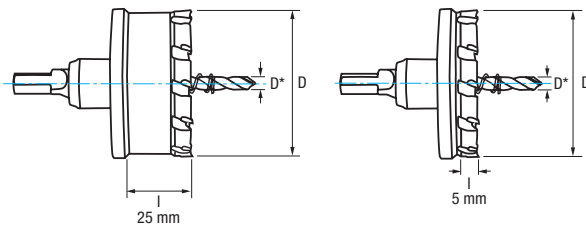

Diente MD
Carbide Tipped
Dent carbure

PVC

Fibra Vidrio
Fiberglass
Fibre de verre

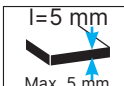

Aceros
<850 N/mm²
Steel / Aciers

INOX
Stainless Steel
Acier INOX

Plásticos
Plastics
Plastiques

D mm	I mm	Pulgadas Inches Pouces	D* mm Broca Drill Bit Foret	Nº Art.	€
16	25	5/8	6	60642	62,37
17	25	11/16	6	60643	62,37
18	25	23/32	6	13796	62,59
19	25	3/4	6	60645	62,37
20	25	25/32	6	13798	63,55
21	25	13/16	6	13799	65,61
22	25	7/8	6	13800	65,61
23	25	14/16	6	13801	66,54
24	25	15/16	6	13802	66,54
25	25	1	6	13803	66,54
26	25	1 1/32	6	13804	70,32
27	25	1 1/16	6	13805	71,47
28	25	1 3/32	6	13806	71,47
29	25	1 1/8	6	13807	71,47
30	25	1 3/16	6	13808	71,47
31	25	1 7/32	6	13809	84,09
32	25	1 1/4	6	13810	87,10
33	25	1 5/16	6	13811	87,10
34	25	1 11/32	6	13812	88,04
35	25	1 3/8	6	13813	88,04
36	25	1 13/32	6	60646	98,65
37	25	1 7/16	6	60647	98,65
38	25	1 1/2	6	13816	101,12
39	25	1 17/32	6	60648	101,12
40	25	1 9/16	6	13818	102,16
41	25	1 5/8	6	60649	111,13
42	25	1 21/32	6	13820	121,03
43	25	1 11/16	6	60652	121,03
44	25	1 3/4	6	60650	121,03
45	25	1 25/32	6	13823	124,47
50	25		6	13828	128,76
52	25	2 1/16	6	13830	149,97
53	25	2 3/32	6	13831	151,03
55	25		6	13833	151,03
60	25	2 3/8	6	13838	167,75
63	25		6	13841	211,39
65	25	2 9/16	6	60651	211,39
70	25	2 3/4	6	60653	211,64
75	25		6	60654	220,39
80	25		6	60655	231,54
85	25		6	60656	253,26
90	25		6	60657	272,05
95	25	3 3/4	6	60658	293,45
100	25	3 15/16	6	60659	312,42

D mm	I mm	Pulgadas Inches Pouces	D* mm Broca Drill Bit Foret	Nº Art.	€
14	5	9/16	6	60660	41,88
16	5	5/8	6	60661	41,88
18	5	23/32	6	60662	41,88
20	5	25/32	6	60663	41,88
22	5	7/8	6	60664	47,05
25	5	1	6	60666	47,05
30	5	1 3/16	6	60667	50,04
32	5	1 1/4	6	60668	56,16
35	5	1 3/8	6	60669	56,16
40	5	1 9/16	6	60670	62,28
45	5	1 25/32	6	60671	68,57
50	5		6	60672	74,25
60	5	2 3/8	6	60673	89,54

* **Broca y muelle incluidos**
Drill Bit & Spring included
Foret et ressort inclus

Display
66

CORONAS INOX
TCT STAINLESS Hole Saws
Trépan INOX



19 cm

∅	16	18	20	22	24	25	27	32
Pcs	1	1	1	1	1	1	1	1

Ref. 4995 - Nº Art. 71094: **545,77 €**

* **Broca y muelle incluidos**
Drill Bit & Spring included
Foret et ressort inclus



Ref. 1664



Broca / Drill Bit / Foret

D mm	L mm	Cap.	N° Art.	€ 1 ud.
5	48	12-15	83478	3,72
6	48	16-100	60704	3,92



Muelle / Spring / Ressort

D mm	L mm		N° Art.	€ pack
8,5	20	10	60637	0,90
8,5	35	10	60638	0,92

Ref. 1636

PERFORADOR DE CHAPA

Screw Hole Punch
Perforateur de tôle



HSS

 Chapa
Sheets
Tôle

Aceros
<850 N/mm²
Steel / Aciers

INOX
Stainless Steel
Acier INOX

D mm	D mm Broca Drill Bit - Foret	N° Art.	€
32,50	12,00	13671	50,25
35,00	12,00	13676	50,25

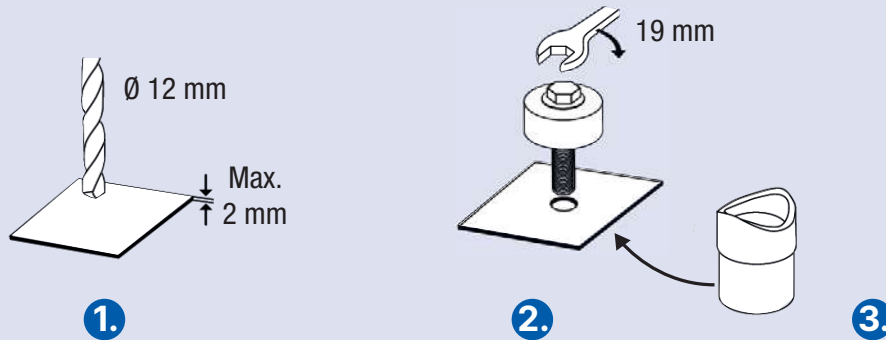

INSTRUCCIONES USO:

1. Taladrar un agujero previo con la broca
2. Introducir el tornillo por el agujero y por el lado contrario enroscar la cuchilla
3. Aplicar un par de apriete hasta seccionar la chapa

DIRECTIONS FOR USE:

1. Drill a pilot hole with the drill bit
2. Insert the screw through the hole and, on the opposite side, screw the blade
3. Apply a tightening torque until the sheet is divided

INSTRUCTIONS D'EMPLOI:

1. Percez un trou de guidage avec le foret
2. Insérez la vis dans le trou et, du côté opposé, vissez la lame
3. Appliquez un couple de serrage jusqu'à ce que la tôle soit divisée



ESCARIADORES

Reamers

Alésoirs

Ref. **2010**

ESCARIADOR MANO

Hand Reamer
Alésoir à main

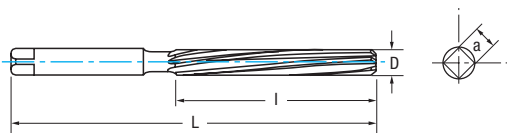

HSS

DIN 206 B

ISO 236

Tol. H7

Aceros
<850 N/mm²
Steel / Aciers

Aluminio
Aluminium



	D mm	L mm	I mm	a mm	Nº Art.	€
New!	1,00	37	12		30685	46,51
New!	1,50	41	20	1,12	30689	37,34
	1,60	44	21	1,25	74178	25,22
	1,70	44	21	1,25	74181	25,22
	1,80	47	23	1,40	74184	25,22
	1,90	50	25	1,60	74187	25,22
	2,00	50	25	1,60	40379	18,90
	2,10	50	25	1,60	74190	25,22
	2,20	54	27	1,80	74193	25,22
	2,40	58	29	2,10	74199	25,22
	2,50	58	29	2,10	40382	18,90
	2,60	58	29	2,10	75397	25,22
	2,70	62	31	2,10	74202	25,22
New!	2,90	62	31	2,10	74208	25,22
	2,80	62	31	2,10	74205	25,22
	3,00	62	31	2,10	40385	18,90
	3,10	66	33	2,40	74211	25,22
	3,20	66	33	2,40	74214	25,22
	3,30	66	33	2,40	74217	25,22
	3,40	71	35	2,70	74220	25,22
	3,50	71	35	2,70	40388	19,82
	3,60	71	35	2,70	74223	25,22
	3,70	71	35	2,70	74226	25,22
	3,80	76	38	3,00	75398	25,22
	3,90	76	38	3,00	74229	25,22
	4,00	76	38	3,00	40391	18,90
	4,10	76	38	3,00	74232	26,35
	4,20	76	38	3,00	74235	26,35
	4,30	81	41	3,40	74238	26,35
	4,40	81	41	3,40	74241	26,35
	4,50	81	41	3,40	40394	19,73
	4,70	81	41	3,40	74247	26,35
	4,80	87	44	3,80	74250	26,35
	4,90	87	44	3,80	74253	26,35
	5,00	87	44	3,80	40397	19,73
	5,10	87	44	3,80	74256	26,35
	5,20	87	44	3,80	74259	26,35
	5,30	87	44	3,80	74262	26,35
	5,40	93	47	4,30	74265	26,35
	5,50	93	47	4,30	40400	19,73
	5,60	93	47	4,30	74268	26,35
	5,70	93	47	4,30	74271	26,35

	D mm	L mm	I mm	a mm	Nº Art.	€
	5,80	93	47	4,30	74274	26,35
	5,90	93	47	4,30	74277	26,35
	6,00	93	47	4,30	40403	19,73
	6,10	100	50	4,90	74280	26,35
	6,20	100	50	4,90	75172	26,35
	6,30	100	50	4,90	74283	26,35
	6,40	100	50	4,90	74286	26,35
	6,50	100	50	4,90	40406	19,73
	6,60	100	50	4,90	75233	26,35
	6,70	100	50	4,90	74289	26,35
	6,80	107	54	5,50	74292	26,35
	6,90	107	54	5,50	74295	26,35
	7,00	107	54	5,50	40409	19,73
	7,10	107	54	5,50	74298	27,82
	7,20	107	54	5,50	74301	27,82
	7,30	107	54	5,50	74947	27,82
New!	7,40	107	54	5,50	74304	27,82
	7,50	107	54	5,50	40412	20,86
	7,60	115	58	6,20	74307	27,82
	7,80	115	58	6,20	74313	27,82
	7,90	115	58	6,20	74316	27,82
	8,00	115	58	6,20	40415	20,86
	8,10	115	58	6,20	74319	29,21
	8,20	115	58	6,20	74322	29,21
	8,30	115	58	6,20	74325	29,21
	8,50	115	58	6,20	40418	21,87
	8,60	124	62	7,00	74331	29,21
	8,80	124	62	7,00	74337	29,21
	8,90	124	62	7,00	74340	29,21
	9,00	124	62	7,00	40421	24,04
	9,10	124	62	7,00	74343	30,49
	9,20	124	62	7,00	74346	30,49
	9,30	124	62	7,00	74349	30,49
	9,40	124	62	7,00	74352	30,49
	9,50	124	62	7,00	40424	25,09
	9,60	133	66	8,00	74355	30,49
	9,70	133	66	8,00	74358	30,49
	9,80	133	66	8,00	74361	30,49
	9,90	133	66	8,00	74364	30,49
	10,00	133	66	8,00	40427	25,09
	10,10	133	66	8,00	74367	38,53

	D mm	L mm	I mm	a mm	Nº Art.	€
	10,20	133	66	8,00	74370	38,53
	10,30	133	66	8,00	74373	38,53
	10,50	133	66	8,00	40430	28,05
	10,60	142	71	8,00	74379	38,53
	10,70	142	71	9,00	74382	38,53
	10,80	142	71	9,00	74385	38,53
	11,00	142	71	9,00	40433	28,05
	11,10	142	71	9,00	74391	41,48
	11,20	142	71	9,00	74394	41,48
	11,30	142	71	9,00	74397	41,48
	11,40	142	71	9,00	74400	41,48
	11,50	142	71	9,00	40436	41,48
	11,60	142	71	9,00	74403	41,48
	11,70	142	71	9,00	74406	41,48
	11,80	152	76	9,00	74409	41,48
	11,90	152	76	10,00	74412	41,48
	12,00	152	76	10,00	40439	40,70
	12,50	152	76	10,00	40442	51,96
	13,00	152	76	10,00	40445	51,96
	13,50	163	81	11,00	40448	68,38
	14,00	163	81	11,00	40451	55,51
	14,50	163	81	11,00	40454	60,63
	15,00	163	81	11,00	40457	60,63
	15,50	175	87	12,00	40460	65,94
	16,00	175	87	12,00	40463	65,94
	16,50	175	87	12,00	40466	83,55
	17,00	175	87	12,00	40469	79,41
	17,50	188	93	14,50	40472	88,67
	18,00	188	93	14,50	40475	95,22
	18,50	188	93	14,50	40478	95,22
	19,00	188	93	14,50	40481	95,22
	20,00	201	100	16,00	40487	97,49
	21,00	201	100	16,00	40493	97,49
	22,00	215	107	18,00	40499	101,01
	23,00	215	107	18,00	40505	105,51
	24,00	231	115	20,00	40511	116,50
	25,00	231	115	20,00	40517	123,66
	26,00	231	115	20,00	40523	135,14
	27,00	247	124	22,40	40529	147,34
	28,00	247	124	22,40	40535	152,50
	30,00	247	124	22,40	40547	201,84



AVELLANADORES

Countersinks / Counterbores

Outils

Ref. **2575**

AVELLANADOR MANGO CILÍNDRICO 90°

90° Straight Shank Countersink

Fraise à noyer 90°

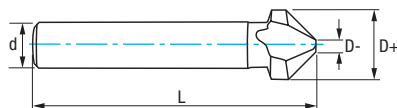

HSSE 5% Co	DIN 335 C	α 90°	3 Z	Tol. D ($\pm 0,05$)	Tol. d (h9)	Tol. L (± 1)	Tol. α -1
----------------------	--------------	--------------	-----	--------------------------	----------------	-----------------------	---------------------

Aceros <850 N/mm ² Steel / Aciers	INOX Stainless Steel Acier INOX	Cobre Copper Cuivre	Aluminio Aluminium	Termoplásticos Thermoplastics Thermoplastiques
---	--	----------------------------------	------------------------------	---

D+ mm	D- mm	d mm	L mm	Nº Art.	€
4,30	1,30	4,00	40	74653	13,89
5,00	1,50	4,00	40	74654	13,47
5,30	1,50	4,00	40	74655	13,78
5,80	1,50	5,00	45	74656	14,09
6,00	1,50	5,00	45	74657	14,09
6,30	1,50	5,00	45	74658	13,61
7,00	1,80	6,00	50	74659	13,76
7,30	1,80	6,00	50	74660	13,95
8,00	2,00	6,00	50	74661	14,72
8,30	2,00	6,00	50	74662	14,87
9,40	2,20	6,00	50	74663	15,51
10,00	2,50	6,00	50	74664	16,27
10,40	2,50	6,00	50	74665	19,39
11,50	2,80	8,00	56	74666	18,01
12,40	2,80	8,00	56	74667	18,62
13,40	2,90	8,00	56	74668	20,35
15,00	3,20	10,00	60	74669	23,00
16,50	3,20	10,00	60	74670	26,40
19,00	3,50	10,00	63	74671	34,42
20,50	3,50	10,00	63	74672	35,23
23,00	3,80	10,00	67	74673	43,05
25,00	3,80	10,00	67	74674	46,20
28,00	4,00	12,00	71	42714	64,70
30,00	4,20	12,00	71	12588	69,22
31,00	4,20	12,00	71	42715	69,22
40,00	5,00	15,00	80	11061	125,88



Set 6 Pcs

Cont. Ø	Nº Art.	€
6,3-8,3-10,4-12,4-16,5-20,5	40515	128,12

Recubrimiento bajo demanda / Coating upon request / Revêtement sur demande

Línea 33 cm - Ref. 2575



Ø	5	6	7	10	12,4	15
Pcs	2	2	2	2	2	2

Ref. 4995 - Nº Art. 70987: **198,42 €**



Ref. **2530**

AVELLANADOR MANGO CILÍNDRICO ALLEN

Allen Straight Shank Counterbore
Fraise à lamer et chambrer

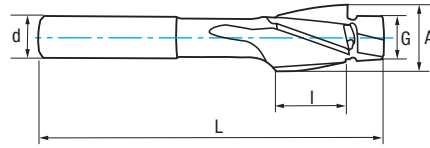

HSS	DIN 373	ISO 4206	Allen		Tol. A z9	Tol. G e8	Tol. d h9	Aluminio Aluminium >10% Si
------------	---------	----------	-------	--	-----------	-----------	-----------	--

Aceros <850 N/mm² Steel / Aciers	Aceros <1000 N/mm² Steel / Aciers	INOX Ferríticos-Martensíticos Ferritic-Martensitic Stainless INOX Ferritiques-Martensitiques	Fundición Cast Iron Fonte	Titanio Titanium Titane	Cobre Copper Cuivre
---	--	---	--	--	------------------------------------

M	A mm	G mm	d mm	L mm	I mm	Z	Nº Art.	€
M3	6,50	3,40	5,00	71	14	3	42029	20,76
M4	8,00	4,50	5,00	71	14	3	42032	20,76
M5	10,00	5,50	8,00	80	18	3	42035	20,76
M6	11,00	6,60	8,00	80	18	3	42038	23,40
M8	15,00	9,00	12,50	100	22	3	42041	28,96
M10	18,00	11,00	12,50	100	22	3	42044	34,47
M12	20,00	13,50	12,50	100	22	3	42047	40,81
M14	24,00	15,50	16,00	100	22	4	42050	61,00
M16	26,00	17,50	16,00	100	22	4	42053	67,44



Set 6 Pcs

Cont.	Nº Art.	€
M3-M4-M5- M6-M8-M10	40512	149,11

Línea 33 cm - Ref. 2530



∅	M5	M6	M8	M10	M12
Pcs	1	1	1	1	1

Ref. 4995 - Nº Art. 72112: 148,4 €



Ref. **2572**

AVELLANADOR MANGO CILÍNDRICO 90°

90° Straight Shank Countersink
Fraise à ebavurer 90°

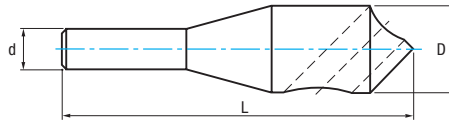

HSSE 5% Co	IZAR Std.	α 90°	Tol. D +0 +0,3	Tol. d (h9)	Tol. L (\pm 1)	Tol. α 0 -1
----------------------	--------------	--------------	-------------------------	----------------	----------------------	--------------------------

Aceros
<850 N/mm²
Steel / Aciers

INOX Ferríticos-Martensíticos
Ferritic-Martensitic Stainless
INOX Ferritiques-Martensitiques

Aluminio
Aluminium

Aplic. mm	D mm	d mm	L mm	N° Art.	€
2-5	10,00	6,00	46	69183	24,19
5-10	14,00	8,00	55	69181	32,65
10-15	20,00	10,00	65	69184	60,41
15-20	28,00	12,00	85	69187	114,88
20-25	30,00	15,00	95	69186	163,26



Set 4 Pcs

Aplic. mm	N° Art.	€
2-5, 5-10, 10-15, 15-20	40513	232,13

Línea 33 cm - Ref. 2572



∅	2-5	5-10	10-15	15-20	20-25
Pcs	1	1	1	1	1

Ref. 4995 - N° Art. 72115: 395,39 €



MACHOS Y COJINETES

Taps & Dies

Tarauts et Filières

Ref. **3030**

JUEGO MACHOS MANO MÉTRICA

Metric Hand Tap Set

Jeu de tarauds à main métrique

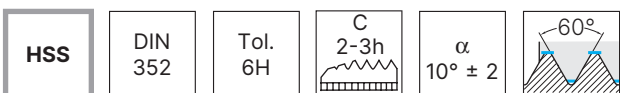
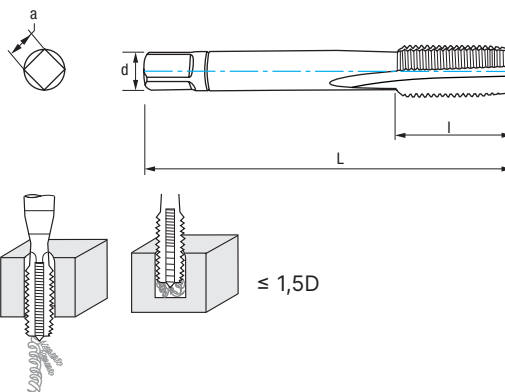

M	P	L mm	l mm	d mm	a mm	Z	Nº Art.	€
M2	0,40	36	8	2,80	2,10	3	62531	29,17
M2,5	0,45	40	9	2,80	2,10	3	62534	29,17
M3	0,50	40	11	3,50	2,70	3	62537	16,51
M3,5	0,60	45	13	4,00	3,00	3	62540	19,45
M4	0,70	45	13	4,50	3,40	3	62543	16,51
M4	0,75	45	14	4,50	3,40	3	76377	28,58
M4,5	0,75	50	16	6,00	4,90	3	62546	29,17
M5	0,80	50	16	6,00	4,90	3	62549	17,50
M6	1,00	56	19	6,00	4,90	3	62552	17,50
M7	1,00	56	19	6,00	4,90	3	62555	21,39
M8	1,25	56	22	6,00	4,90	4	62561	21,39
M9	1,25	63	22	7,00	5,50	4	62567	34,99
M10	1,50	70	24	7,00	5,50	4	62573	26,27
M11	1,50	70	24	8,00	6,20	4	62576	43,73
M12	1,75	75	28	9,00	7,00	4	62579	36,93
M13	1,75	75	28	9,00	7,00	4	62582	67,06
M14	2,00	80	30	11,00	9,00	4	62585	40,84

M	P	L mm	l mm	d mm	a mm	Z	Nº Art.	€
M15	2,00	80	32	12,00	9,00	4	62588	81,65
M16	2,00	80	32	12,00	9,00	4	62591	57,95
M18	2,50	95	34	14,00	11,00	4	62594	76,80
M20	2,50	95	34	16,00	12,00	4	62597	86,53
M22	2,50	100	34	18,00	14,50	4	62603	115,70
M24	3,00	110	50	18,00	14,50	4	62606	135,59
M27	3,00	110	50	20,00	16,00	4	62609	174,49
M30	3,50	125	50	22,00	18,00	4	62612	223,56
M33	3,50	125	50	25,00	20,00	4	62615	281,90
M36	4,00	150	56	28,00	22,00	4	62618	359,63
M39	4,00	150	60	32,00	24,00	4	62621	402,46
M42	4,50	150	60	32,00	24,00	4	62624	503,54
M45	4,50	160	65	36,00	29,00	6	73760	581,31
M48	5,00	180	70	36,00	29,00	6	62627	699,89
M52	5,00	180	70	40,00	32,00	6	76382	849,61
M56	5,50	180	70	40,00	32,00	6	76383	1.310,20
M60	5,50	200	85	45,00	35,00	6	76384	1.639,82

Macho único Ref. 3010 disponible en [pag. 140](#)

Single Tap Ref. 3010 available in [page 140](#)

Taraut unique Ref. 3010 disponible [pag. 140](#)



Ref. **3003**

JUEGO MACHOS MANO MÉTRICA

Metric Hand Tap Set

Jeu de tarauds à main métrique

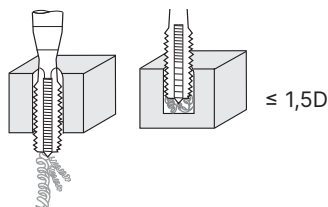
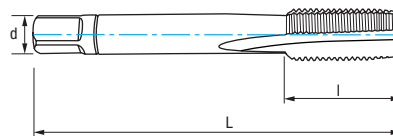

HSS

DIN 352

Tol. 6H

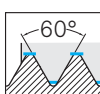

Aceros
 <math><850 \text{ N/mm}^2</math>
 Steel / Aciers

Fundición
 Cast Iron
 Fonte

Cobre
 Copper
 Cuivre

Aluminio
 Aluminium

M	P	L mm	l mm	d mm	a mm	Z	Nº Art.	€
M3	0,50	40	11	3,50	2,70	3	42876	16,84
M4	0,70	45	13	4,50	3,40	3	42879	16,84
M5	0,80	50	16	6,00	4,90	3	42882	17,84
M6	1,00	56	19	6,00	4,90	3	42884	17,84
M7	1,00	56	19	6,00	4,90	3	42885	21,81
M8	1,25	63	22	6,00	4,90	4	42886	21,81
M10	1,50	70	24	7,00	5,50	4	42887	26,78
M12	1,75	75	28	9,00	7,00	3	42888	37,65
M14	2,00	80	30	11,00	9,00	4	42889	41,63
M16	2,00	80	32	12,00	9,00	4	42890	59,08
M18	2,50	95	34	14,00	11,00	4	42891	78,29
M20	2,50	95	34	16,00	12,00	4	42892	88,20



Macho único Ref. 3001 disponible en [pag. 143](#)

Single Tap Ref. 3001 available in [page 143](#)

Taraud unique Ref. 3001 disponible [pag. 143](#)

Línea 33 cm - Ref. 3003



∅	M3	M5	M6	M10	M12
Pcs	3	3	3	3	3

Ref. 4995 - Nº Art. 70990: 350,85 €



Display 22 - Ref. 3003



∅	M20	Mod. 01	Mod. 02	Mod. 10	Mod. 20		
Pcs	1	1	1	1	1		
∅	M12	M14	M16	M18			
Pcs	2	1	1	1			
∅	M-3	M-4	M-5	M-6	M-7	M-8	M10
Pcs	2	2	2	2	2	2	2

Ref. 4995 - N° Art. 22298: 756,08 €

Display 44 - Ref. 3003



∅	M-4	M-5	M-6	M-8	M-10	01
Pcs	2	2	2	2	2	2

Ref. 4995 - N° Art. 42490: 248,32 €

Ref. **3036**

JUEGO MACHOS MANO MÉTRICA/ MÉTRICA FINA COBALTO INOX

STAINLESS Cobalt Metric / Metric Fine Hand Tap Set

Jeu de tarauds à main métrique / métrique pas fin Cobalt INOX

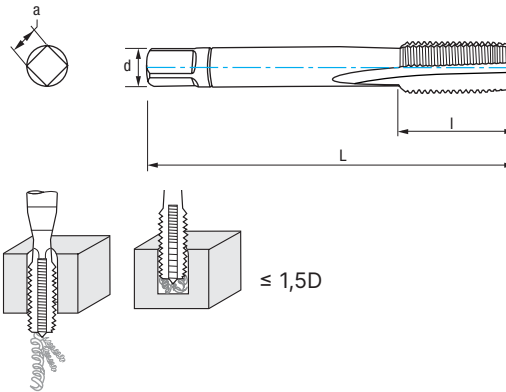

HSSE 5% Co	M DIN 352	MF DIN 2181	Tol. 6H	Vaporiz.	C 2-3h	α 6-8°	60°	Vaporizado Vaporized Vaporisée
----------------------	-----------------	-------------------	------------	----------	-----------	------------------	-----	---

Grupo Group-Gruppe P	Subgrup. P.5	INOX Stainless Steel Acier INOX	Fundición Cast Iron Fonte	Nº1 Desbaste Roughing Ébauche	Nº2 Semidesbaste Semiroughing Semi-ébauche	Nº3 Acabado Finishing Finition	Nº1-Nº2 Con guía Guided Avec guide
-----------------------------------	------------------------	--	--	--	---	---	---

M	P	L mm	l mm	d mm	a mm	Z	Nº Art.	€
M2	0,40	36	8	2,80	2,10	3	69229	38,15
M3	0,50	40	11	3,50	2,70	3	16404	30,52
M4	0,70	45	13	4,50	3,40	3	16405	30,52
M5	0,80	50	16	6,00	4,90	3	16406	31,78
MF6	0,75	56	14	6,00	4,90	3	82254	59,06
MF6	1,00	56	19	6,00	4,90	3	16407	31,78
MF8	1,00	63	18	6,00	4,90	3	82255	59,06
MF8	1,25	63	22	6,00	4,90	3	16408	36,90
MF10	1,00	63	18	7,00	5,50	3	82256	65,57
MF10	1,50	70	24	7,00	5,50	3	16409	47,46
MF12	1,00	70	18	9,00	7,00	3	82257	74,89
MF12	1,50	70	22	9,00	7,00	3	82258	73,16
MF12	1,75	75	29	9,00	7,00	3	16410	67,92
MF14	1,50	70	22	11,00	9,00	4	82259	91,18
MF14	2,00	80	30	11,00	9,00	4	16411	75,22
MF16	1,50	70	22	12,00	9,00	4	82290	94,45
MF16	2,00	80	32	12,00	9,00	4	16412	103,09
MF18	1,50	80	22	14,00	11,00	4	82260	137,88
MF18	2,50	95	40	14,00	11,00	4	16413	140,81
MF20	1,50	80	22	16,00	12,00	4	82261	134,18
MF20	2,50	95	40	16,00	12,00	4	16414	156,34



Ref. **3037**

MACHO ÚNICO MÉTRICA/ MÉTRICA FINA COBALTO INOX

STAINLESS Cobalt Metric / Metric Fine Hand **Single Tap**

Taroud à main **unique** métrique / métrique pas fin Cobalt INOX

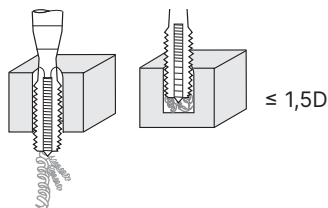
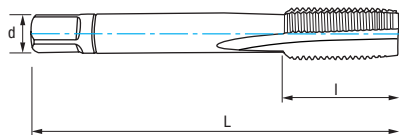

HSSE
5% Co

M
DIN
352

MF
DIN
2181

Tol.
6H

Vaporiz.

C
2-3h

α
6-8°

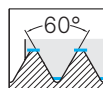

Grupo
Group-Grp
P

Subgrup.
P.5

INOX
Stainless Steel
Acier INOX

Fundición
Cast Iron
Fonte

N°1 Desbaste
Roughing
Ébauche

N°2 Semidesbaste
Semiroughing
Semi-ébauche

N°3 Acabado
Finishing
Finition

N°1-N°2 Con guía
Guided
Avec guide

M	P	L mm	I mm	d mm	a mm	Z	N° 3	N° 1	N° 2	€
							Acabado Finishing Finition	Desbaste Roughing Ébauche	Semidesbaste Semiroughing Semi-Ébauche	
M2	0,40	36	8	2,80	2,10	3	83127	83125	83126	12,96
M3	0,50	40	11	3,50	2,70	3	74981	74979	74980	10,37
M4	0,70	45	13	4,50	3,40	3	75010	74982	74983	10,37
M5	0,80	50	16	6,00	4,90	3	74986	74984	74985	10,79
MF6	0,75	56	14	6,00	4,90	3	82264	82262		29,51
M6	1,00	56	19	6,00	4,90	3	74990	74988	74989	10,79
MF8	1,00	63	18	6,00	4,90	3	82267	82265		29,51
M8	1,25	63	22	6,00	4,90	3	74993	74991	74992	12,55
MF10	1,00	63	18	7,00	5,50	3	82270	82268		32,81
M10	1,50	70	24	7,00	5,50	3	74998	74994	74997	16,14
MF12	1,00	70	18	9,00	7,00	3	82273	82271		37,47
MF12	1,50	70	22	9,00	7,00	3	82276	82274		36,59
M12	1,75	75	29	9,00	7,00	3	75003	74999	75000	23,09
MF14	1,50	70	22	11,00	9,00	4	82279	82277		45,60
M14	2,00	80	30	11,00	9,00	4	75006	75004	75005	25,59
MF16	1,50	70	22	12,00	9,00	4	82283	82280		47,22
M16	2,00	80	32	12,00	9,00	4	74974	72865	72864	35,06
MF18	1,50	80	22	14,00	11,00	4	82286	82284		68,90
M18	2,50	95	40	14,00	11,00	4	75009	75007	75008	47,88
MF20	1,50	80	22	16,00	12,00	4	82289	82287		67,10
M20	2,50	95	40	16,00	12,00	4	59960	74131	74977	53,16



Ref. **3020**

JUEGO MACHOS MANO MÉTRICA FINA

Metric Fine Hand Tap Set

Jeu de tarauds à main métrique pas fin

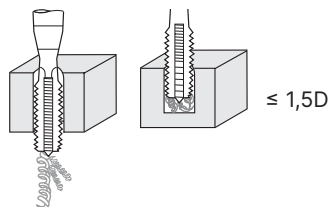
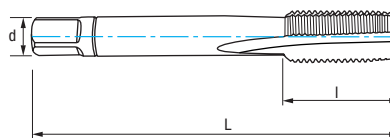

HSS

DIN 2181

Tol. 6H

C 2-3h

α $10^\circ \pm 2$

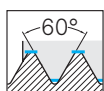

Nº1 Desbaste
Roughing
Ébauche

Nº3 Acabado
Finishing
Finition

Aceros
<math><850 \text{ N/mm}^2</math>
Steel / Aciers

Fundición
Cast Iron
Fonte

Cobre
Copper
Cuivre

Aluminio
Aluminium



MF	P	L mm	l mm	d mm	a mm	Z	Nº Art.	€
MF4	0,50	45	10	4,50	3,40	3	62336	32,87
MF5	0,50	50	12	6,00	4,90	3	62342	32,70
MF5	0,75	50	12	6,00	4,90	3	62345	33,07
MF6	0,50	50	14	6,00	4,90	3	62351	23,36
MF6	0,75	50	14	6,00	4,90	3	62354	19,79
MF7	0,75	50	14	6,00	4,90	3	62360	30,11
MF8	0,50	50	19	6,00	4,90	4	62366	44,79
MF8	0,75	50	19	6,00	4,90	4	62369	27,19
MF8	1,00	56	20	6,00	4,90	4	62372	19,70
MF9	1,00	63	20	7,00	5,50	4	75090	33,43
MF10	0,50	63	20	7,00	5,50	4	21727	42,72
MF10	0,75	63	20	7,00	5,50	4	76309	50,56
MF10	1,00	63	20	7,00	5,50	4	62378	21,23
MF10	1,25	70	24	7,00	5,50	4	62381	21,50
MF11	0,75	63	20	8,00	6,20	4	16118	104,76
MF11	1,00	63	20	8,00	6,20	4	76311	46,62
MF11	1,25	63	20	8,00	6,20	4	75298	46,62
MF12	0,75	70	22	9,00	7,00	4	76312	57,90
MF12	1,00	70	20	9,00	7,00	4	62387	37,12
MF12	1,25	70	22	9,00	7,00	4	62390	37,19
MF12	1,50	70	22	9,00	7,00	4	62393	31,70
MF13	0,75	70	22	11,00	9,00	4	56832	104,76
MF13	1,00	70	20	11,00	9,00	4	76314	66,31
MF13	1,25	70	22	11,00	9,00	4	76315	58,59
MF13	1,50	70	22	11,00	9,00	4	62399	58,59
MF14	0,75	70	22	11,00	9,00	4	56833	103,13
MF14	1,00	70	20	11,00	9,00	4	62402	66,31
MF14	1,25	70	20	11,00	9,00	4	62405	45,43
MF14	1,50	70	20	11,00	9,00	4	62408	35,30
MF14	1,75	70	30	11,00	9,00	4	10875	135,39
MF15	1,00	70	20	12,00	9,00	4	76318	92,79
MF15	1,25	70	22	12,00	9,00	4	76319	84,56
MF15	1,50	70	20	12,00	9,00	4	75299	85,95
MF16	1,00	70	20	12,00	9,00	4	62414	92,84
MF16	1,25	70	20	12,00	9,00	4	76320	97,74
MF16	1,50	70	20	12,00	9,00	4	62417	44,19

MF	P	L mm	l mm	d mm	a mm	Z	Nº Art.	€
MF17	1,00	70	22	12,00	9,00	4	76321	124,64
MF17	1,25	70	22	12,00	9,00	4	56834	124,64
MF17	1,50	70	22	12,00	9,00	4	62420	124,64
MF18	1,00	80	22	14,00	11,00	4	62423	103,25
MF18	1,25	80	22	14,00	11,00	4	76323	122,85
MF18	1,50	80	22	14,00	11,00	4	62426	58,36
MF18	2,00	80	22	14,00	11,00	4	62429	110,15
MF19	1,00	80	22	14,00	11,00	4	10831	180,90
MF19	1,25	80	22	14,00	11,00	4	56835	180,75
MF19	1,50	80	22	14,00	11,00	4	76326	180,90
MF19	2,00	80	22	14,00	11,00	4	56837	215,49
MF20	1,00	80	22	16,00	12,00	4	76327	136,77
MF20	1,25	80	22	16,00	12,00	4	74816	180,90
MF20	1,50	80	22	16,00	12,00	4	62435	73,16
MF20	2,00	80	22	16,00	12,00	4	62438	114,69
MF21	1,00	80	22	16,00	12,00	4	56838	233,78
MF21	1,25	80	22	16,00	12,00	4	56840	233,78
MF21	1,50	80	22	16,00	12,00	4	75300	184,86
MF22	1,00	80	22	18,00	14,50	4	76330	153,29
MF22	1,25	80	22	18,00	14,50	4	74601	180,90
MF22	1,50	80	22	18,00	14,50	4	62441	79,77
MF22	2,00	80	22	18,00	14,50	4	62444	127,73
MF23	1,00	80	22	18,00	14,50	4	56841	233,54
MF23	1,50	80	22	18,00	14,50	4	56842	233,54
MF24	1,00	90	22	18,00	14,50	4	76333	143,55
MF24	1,25	90	22	18,00	14,50	4	62447	233,78
MF24	1,50	90	22	18,00	14,50	4	62450	101,82
MF24	2,00	90	22	18,00	14,50	4	62453	171,38
MF25	1,00	90	22	18,00	14,50	4	76334	204,55
MF25	1,25	90	22	18,00	14,50	4	56843	333,06
MF25	1,50	90	22	18,00	14,50	4	75301	200,97
MF25	2,00	90	22	18,00	14,50	4	56844	342,58
MF26	1,00	90	22	18,00	14,50	4	56846	178,75
MF26	1,50	90	22	18,00	14,50	4	75302	193,99
MF26	2,00	90	22	18,00	14,50	4	56847	196,77
MF27	1,00	90	22	20,00	16,00	4	76338	196,81

Cont.



Cont.

MF	P	L mm	l mm	d mm	a mm	Z	Nº Art.	€
MF27	1,50	90	22	20,00	16,00	4	76339	213,88
MF27	2,00	90	22	20,00	16,00	4	75303	237,59
MF28	1,00	90	22	20,00	16,00	4	76340	333,37
MF28	1,50	90	22	20,00	16,00	4	76341	215,48
MF30	1,00	90	22	22,00	18,00	4	76342	206,85
MF30	1,50	90	22	22,00	18,00	4	76343	223,50
MF30	2,00	90	22	22,00	18,00	4	75304	257,62
(New!) MF30	3,00	90	22	22,00	18,00	4	14421	257,62
MF32	1,50	90	22	22,00	18,00	4	76345	258,03
MF33	1,50	100	25	25,00	20,00	4	76348	303,28
MF33	2,00	100	25	25,00	20,00	4	75305	383,02
MF34	1,50	100	25	28,00	22,00	4	76349	316,10
MF35	1,50	100	25	28,00	22,00	4	76350	316,10
MF36	1,50	100	25	28,00	22,00	4	76351	348,15
MF36	2,00	125	33	28,00	22,00	4	76140	445,51
MF36	3,00	125	33	28,00	22,00	4	76352	511,12
MF38	1,50	100	25	28,00	22,00	4	76353	391,55
MF38	2,00	125	40	28,00	22,00	4	75306	465,45
MF39	1,50	110	25	32,00	24,00	4	76354	511,12
MF39	2,00	125	33	32,00	24,00	4	76355	610,45
MF39	3,00	125	33	32,00	24,00	4	76356	511,12
MF40	1,50	110	25	32,00	24,00	6	76357	459,96
MF40	2,00	110	25	32,00	24,00	6	76358	449,23
MF40	3,00	125	40	32,00	24,00	6	76359	445,06
MF42	2,00	125	33	32,00	24,00	6	76361	611,27
MF42	3,00	125	33	32,00	24,00	6	76362	611,27
MF45	1,50	110	25	36,00	29,00	6	76363	481,62
MF45	2,00	125	33	36,00	29,00	6	76364	733,86
MF45	3,00	125	33	36,00	29,00	6	76365	786,79
MF48	1,50	140	33	36,00	29,00	6	76366	542,71
MF48	2,00	140	33	36,00	29,00	6	76367	889,26
MF48	3,00	140	33	36,00	29,00	6	76368	889,32
MF50	1,50	140	40	36,00	29,00	6	76369	593,52
MF52	1,50	140	40	40,00	32,00	6	76370	629,62
MF52	2,00	140	40	40,00	32,00	6	77643	905,81
MF52	3,00	140	40	40,00	32,00	6	76372	840,98



Ref. **3010**

MACHO ÚNICO MANO MÉTRICA/ MÉTRICA FINA

Metric / Metric Fine Hand **Single Tap**

Taroud à main **unique** métrique / métrique pas fin

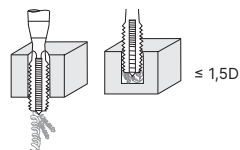
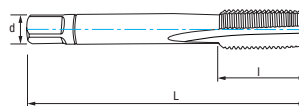

HSS	M DIN 352	MF DIN 2181	Tol. 6H	C 2-3h	α $10^\circ \pm 2$	60°
------------	-----------------	-------------------	------------	-----------	------------------------------	-----

Aceros <850 N/mm ² Steel / Aciers	Fundición Cast Iron Fonte	Cobre Copper Cuivre	Aluminio Aluminium
---	--	----------------------------------	------------------------------



M/MF	P	L mm	l mm	d mm	a mm	Z	N°3 Acabado Finishing Finition (M Ref. 3030 / MF Ref. 3020)		N° 1 Desbaste M Roughing Ébauche (Ref. 3030)		N° 2 Semidesbaste M Semiroughing Semi-ébauche (Ref. 3030)	
							N° Art.	€	N° Art.	€	N° Art.	€
M2	0,40	36	8	2,80	2,10	3	76385	9,97	22710	9,97	33368	9,97
M2	0,45	41	8	2,50	2,00	3	16451	9,97				
M2,5	0,45	40	9	2,80	2,10	3	76387	9,97				
M3	0,50	40	11	3,50	2,70	3	76389	5,67	11158	5,67	12723	5,67
M3,5	0,60	45	13	4,00	3,00	3	76391	6,70	66186	6,70	20538	6,70
MF4	0,50	45	10	4,50	3,40	3	76393	16,43				
M4	0,70	45	13	4,50	3,40	3	76394	5,67	18943	5,67	11263	5,67
M4,5	0,75	50	16	6,00	4,90	3	76397	9,99	66187	9,99	66192	9,99
MF5	0,50	50	12	6,00	4,90	3	59484	17,37				
MF5	0,75	50	12	6,00	4,90	3	59485	16,45				
M5	0,80	50	16	6,00	4,90	3	76400	6,02	11262	6,02	26620	6,02
MF6	0,50	50	14	6,00	4,90	3	59486	11,95				
MF6	0,75	50	14	6,00	4,90	3	76405	9,89				
M6	1,00	50	19	6,00	4,90	3	75383	6,02	10630	6,02	10833	6,02
MF7	0,75	50	14	6,00	4,90	3	46217	15,06				
M7	1,00	50	19	6,00	4,90	3	76408	7,34	66201	7,34	32812	7,34
MF8	0,50	50	19	6,00	4,90	4	59487	18,52				
MF8	0,75	50	19	6,00	4,90	4	59488	14,67				
MF8	1,00	56	20	6,00	4,90	4	76411	9,86				
M8	1,25	56	22	6,00	4,90	4	75449	7,34	10938	7,34	26629	7,34
MF9	1,00	63	20	7,00	5,50	4	34577	16,72				
M9	1,25	63	22	7,00	5,50	4	76414	11,99	66208	11,99	20543	11,99
MF10	0,50	63	20	7,00	5,50	4	59489	21,36				
MF10	0,75	63	20	7,00	5,50	4	59490	25,29				
MF10	1,00	63	20	7,00	5,50	4	76417	10,60				
MF10	1,25	70	24	7,00	5,50	4	76418	10,75				
M10	1,50	70	24	7,00	5,50	4	74995	8,99	11148	8,99	15086	8,99
MF11	0,75	63	20	8,00	6,20	4	59491	51,52				
MF11	1,00	63	20	8,00	6,20	4	59492	18,54				
MF11	1,25	63	22	8,00	6,20	4	59493	18,69				
M11	1,50	70	24	8,00	6,20	4	76422	15,03	25211	15,03	21282	15,03
MF12	0,75	70	22	9,00	7,00	4	59494	29,67				
MF12	1,00	70	20	9,00	7,00	4	22221	18,58				
MF12	1,25	70	22	9,00	7,00	4	76425	18,61				
MF12	1,50	70	22	9,00	7,00	4	76426	15,86				
M12	1,75	75	29	9,00	7,00	4	74996	12,68	10834	12,68	28407	12,68

MF N°1 bajo demanda upon request sur demande

Cont.



Ref. **3010**

MACHO ÚNICO MANO MÉTRICA/ MÉTRICA FINA

Metric / Metric Fine Hand **Single** Tap

Taraud à main **unique** métrique / métrique pas fin

Cont.

M/MF	P	L mm	I mm	d mm	a mm	Z	Nº3 Acabado Finishing Finition (M Ref. 3030 / MF Ref. 3020)		Nº 1 Desbaste M Roughing Ébauche (Ref. 3030)		Nº 2 Semidesbaste M Semiroughing Semi-ébauche (Ref. 3030)	
							Nº Art.	€	Nº Art.	€	Nº Art.	€
MF13	0,75	70	22	11,00	9,00	4	59495	52,60				
MF13	1,00	70	20	11,00	9,00	4	59496	29,78				
MF13	1,25	70	22	11,00	9,00	4	59497	30,01				
MF13	1,50	70	22	11,00	9,00	4	59498	30,08				
MF14	0,75	70	22	11,00	9,00	4	59499	51,99				
MF14	1,00	70	20	11,00	9,00	4	76433	33,15				
MF14	1,25	70	20	11,00	9,00	4	45040	22,71				
MF14	1,50	70	20	11,00	9,00	4	76435	17,65				
MF14	1,75	70	30	11,00	9,00	4	59500	67,70				
M14	2,00	80	30	11,00	9,00	4	76436	14,01	11772	14,01	20529	14,01
MF15	1,00	70	20	12,00	9,00	4	59501	40,18				
MF15	1,25	70	22	12,00	9,00	4	59503	42,99				
MF15	1,50	70	20	12,00	9,00	4	76439	42,98				
MF16	1,00	70	22	12,00	9,00	4	59504	38,37				
MF16	1,25	70	22	12,00	9,00	4	59505	40,38				
MF16	1,50	70	20	12,00	9,00	4	76443	22,08				
M16	2,00	80	32	12,00	9,00	4	76444	19,87	17461	19,87	16312	19,87
MF17	1,00	70	22	12,00	9,00	4	59506	61,80				
MF17	1,25	70	22	12,00	9,00	4	59507	62,05				
MF17	1,50	70	22	12,00	9,00	4	59562	29,11				
MF18	1,00	80	22	14,00	11,00	4	59508	42,63				
MF18	1,25	80	22	14,00	11,00	4	59509	60,42				
MF18	1,50	80	22	14,00	11,00	4	45039	29,18				
MF18	2,00	80	22	14,00	11,00	4	59510	46,32				
M18	2,50	95	40	14,00	11,00	4	76452	26,35	11916	26,35	66249	26,35
MF19	1,25	80	22	14,00	11,00	4	59511	88,90				
MF19	1,50	80	22	14,00	11,00	4	59512	90,45				
MF19	2,00	80	22	14,00	11,00	4	59513	107,74				
MF20	1,00	80	22	16,00	12,00	4	59514	56,78				
MF20	1,25	80	22	16,00	12,00	4	59515	88,98				
MF20	1,50	80	22	16,00	12,00	4	76476	36,57				
MF20	2,00	80	22	16,00	12,00	4	59516	48,01				
M20	2,50	95	40	16,00	12,00	4	76478	29,66	11917	29,66	17261	29,66
MF21	1,00	80	22	16,00	12,00	4	59517	115,93				
MF21	1,25	80	22	16,00	12,00	4	59518	114,97				
MF21	1,50	80	22	16,00	12,00	4	59519	92,43				
MF22	1,00	80	22	18,00	14,50	4	59521	62,80				
MF22	1,25	80	22	18,00	14,50	4	59522	90,45				
MF22	1,50	80	22	18,00	14,50	4	76484	39,88				
MF22	2,00	80	22	18,00	14,50	4	76485	63,87				
M22	2,50	100	40	18,00	14,50	4	76486	39,69	65789	39,69	15241	39,69
MF23	1,00	80	22	18,00	14,50	4	59523	115,83				
MF23	1,50	80	22	18,00	14,50	4	59524	114,87				
MF24	1,25	90	22	18,00	14,50	4	59525	116,89				
MF24	2,00	90	22	18,00	14,50	4	59526	70,81				
M24	3,00	110	50	18,00	14,50	4	76493	46,51	58475	46,51	12505	46,51
MF25	1,00	90	22	18,00	14,50	4	59527	101,46				
MF25	1,25	90	22	18,00	14,50	4	59528	163,80				
MF25	2,00	90	22	18,00	14,50	4	59561	171,28				
MF26	1,00	90	22	18,00	14,50	4	59529	89,36				
MF26	1,50	90	22	18,00	14,50	4	59530	80,11				
MF26	2,00	90	22	18,00	14,50	4	59531	98,39				
MF27	1,00	90	22	20,00	16,00	4	59532	99,55				
MF27	1,50	90	22	20,00	16,00	4	59533	88,79				
M27	3,00	110	50	20,00	16,00	4	76505	59,88	10836	59,88	66294	59,88
MF28	1,00	90	22	20,00	16,00	4	59534	165,30				

Cont.



Cont.

M/MF	P	L mm	I mm	d mm	a mm	Z	Nº3 Acabado Finishing Finition (M Ref. 3030 / MF Ref. 3020)		Nº 1 Desbaste M Roughing Ébauche (Ref. 3030)		Nº 2 Semidesbaste M Semiroughing Semi-ébauche (Ref. 3030)	
							Nº Art.	€	Nº Art.	€	Nº Art.	€
MF28	1,50	90	22	20,00	16,00	4	59535	89,00				
MF30	1,00	90	22	22,00	18,00	4	16388	124,16				
MF30	1,50	90	22	22,00	18,00	4	59536	92,32				
M30	3,50	125	50	22,00	18,00	4	76512	76,67	26582	76,67	13046	76,67
New! M32	1,50	90	22	22,00	18,00	4	25967	128,81				
MF33	1,50	100	25	25,00	20,00	4	59537	125,24				
MF33	2,00	100	25	25,00	20,00	4	59538	148,91				
M33	3,50	125	56	25,00	20,00	4	76519	96,71	66307	96,71	66308	96,71
MF34	1,50	100	25	28,00	22,00	4	59539	135,53				
MF35	1,50	100	25	28,00	22,00	4	59540	150,30				
MF36	1,50	100	25	28,00	22,00	4	59541	145,16				
MF36	3,00	125	40	28,00	22,00	4	59542	253,44				
M36	4,00	150	63	28,00	22,00	4	76525	123,39	66317	123,39	38036	123,39
MF38	1,50	100	25	28,00	22,00	4	59543	163,31				
MF38	2,00	125	40	28,00	22,00	4	59544	232,73				
MF39	1,50	110	25	32,00	24,00	4	59545	219,02				
MF39	2,00	125	40	32,00	24,00	4	59546	217,21				
MF39	3,00	125	40	28,00	22,00	4	59547	214,90				
M39	4,00	150	63	32,00	24,00	4	76531	138,06	66328	138,06	66329	138,06
MF40	1,50	110	25	32,00	24,00	4	59548	193,38				
MF40	2,00	125	40	32,00	24,00	4	59549	220,92				
MF40	3,00	125	40	32,00	24,00	4	59550	222,54				
MF42	1,50	110	25	32,00	24,00	4	14781	255,85				
MF42	2,00	125	40	32,00	24,00	4	59551	256,97				
MF42	3,00	125	40	32,00	24,00	4	59552	252,77				
M42	4,50	150	63	32,00	24,00	4	76538	172,73	66342	172,73	61071	172,73
MF45	1,50	110	25	36,00	29,00	6	16389	289,06				
MF45	2,00	125	40	36,00	29,00	6	59553	300,92				
MF45	3,00	125	40	36,00	29,00	6	59554	305,93				
M45	4,50	160	70	36,00	29,00	6	76542	199,42	32663	199,42	32664	199,42
MF48	1,50	140	40	36,00	29,00	6	16390	325,78				
MF48	2,00	140	40	36,00	29,00	6	59555	402,52				
MF48	3,00	140	40	36,00	29,00	6	59556	364,32				
M48	5,00	180	75	36,00	29,00	6	76546	240,09	66355	240,09	66356	240,09
MF50	1,50	140	40	36,00	29,00	6	59557	291,89				
MF52	1,50	140	40	40,00	32,00	6	59558	312,23				
MF52	2,00	140	40	40,00	32,00	6	59559	452,91				
MF52	3,00	140	40	40,00	32,00	6	59560	413,61				
M52	5,00	180	75	40,00	32,00	6	76551	291,45	66367	291,45	66368	291,45



Ref. **3001**

MACHO ÚNICO MANO MÉTRICA

Metric Hand **Single** Tap
Taraud à main **unique** métrique

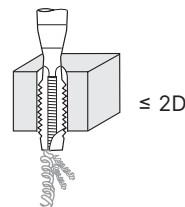
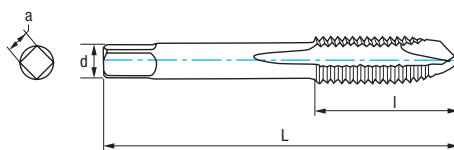

HSS	DIN 352	Tol. 6H	GUN	60°	N°3 Acabado Finishing Finition
------------	---------	---------	-----	-----	---

Aceros <850 N/mm ² Steel / Aciers	Fundición Cast Iron Fonte	Cobre Copper Cuivre	Aluminio Aluminium
---	--	----------------------------------	------------------------------

M	P	L mm	l mm	d mm	a mm	Z	Nº Art.	€
M3	0,50	40	11	3,50	2,70	3	25217	5,60
M4	0,70	45	13	4,00	3,00	3	25218	5,60
M5	0,80	50	16	6,00	4,90	3	25219	5,95
M6	1,00	56	19	6,00	4,90	3	25220	5,95
M8	1,25	56	22	6,00	4,90	4	25222	7,27
M10	1,50	70	24	7,00	5,50	4	25224	8,93
M12	1,75	75	29	9,00	7,00	3	25374	12,57



Línea 33 cm - Ref. 3001



∅	M3	M5	M6	M8	M10
Pcs	3	3	3	3	3

Ref. 4995 - Nº Art. 72118: **101,10 €**



Ref. **3023**

MACHO MANO PERFIL ROSCA COMPLETA

Whole Thread Profile Hand Tap
Taraud à main profil filetage complet

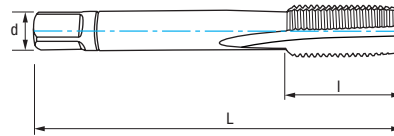

HSS	DIN 352	Tol. 6H	α $10^\circ \pm 2$	4-6h	60°
Aceros <850 N/mm ² Steel / Aciers	Fundición Cast Iron Fonte	Cobre Copper Cuivre	Aluminio Aluminium		

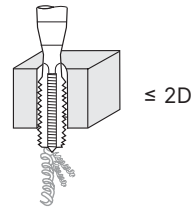

Macho único que **finaliza la rosca completa** en agujeros pasantes. Espesor material <math><1,5\text{ mm}</math>. Viruta media/larga.

Single tap for **whole thread finishing** in through holes. Material thickness <math><1,5\text{ mm}</math>. Medium/long chip removal.

Guidage et filetage complet sur trous débouchants. Épaisseur matériel <math><1,5\text{ mm}</math>. Copeaux moyens/longs.

M	P	L mm	l mm	d mm	a mm	Z	Nº Art.	€
M3	0,50	40	11	3,50	2,70	3	46263	8,50
M4	0,70	45	13	4,50	3,40	3	46264	8,50
M5	0,80	50	16	6,00	4,90	3	46265	9,01
M6	1,00	50	19	6,00	4,90	3	46266	9,01
M8	1,25	56	22	6,00	4,90	4	46267	11,00
M10	1,50	70	24	7,00	5,50	4	46268	13,51
M12	1,75	75	29	9,00	7,00	4	46269	19,03
M16	2,00	80	32	12,00	9,00	4	46270	29,81
M20	2,50	95	40	16,00	12,00	4	46271	44,50



Línea 33 cm - Ref. 3023



∅	M3	M4	M5	M6	M8	M10
Pcs	5	5	5	5	5	5

Ref. 4995 - Nº Art. 72121: 297,65 €



Ref. **3040**

JUEGO MACHOS ÚNICOS MANO MÉTRICA NORMA ISO

ISO Standard Metric Hand Single Tap Set

Jeu de tarauds **uniques** à main métrique **norme ISO**



C 2-3h



B 3,5-5h



A 8h

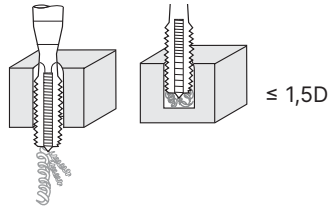
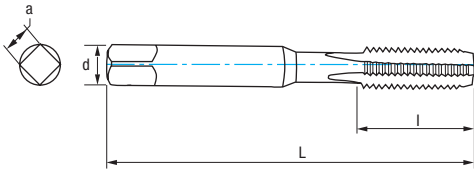

HSS	ISO 529	Tol. 6H	A 8h	B 3,5-5h	C 2-3h		α $10^\circ \pm 2$		Nº3 Acabado Finishing Finition
------------	----------------	---------	------	----------	--------	--	---------------------------	--	---------------------------------------

Aceros <850 N/mm² Steel / Acciai	Fundición Cast Iron Ghisa	Cobre Copper Rame	Aluminio Aluminium Alluminio
--	----------------------------------	--------------------------	-------------------------------------

M	P	L mm	l mm	d mm	a mm	Z	Nº Art.	€
M2	0,40	41	8	2,50	2,00	3	83527	29,17
M3	0,50	48	11	3,15	2,50	3	68870	16,51
M4	0,70	53	13	4,00	3,15	3	68871	16,51
M5	0,80	58	16	5,00	4,00	3	68872	17,50
M6	1,00	66	19	6,30	5,00	3	68873	17,50
M8	1,25	72	22	8,00	6,30	4	68874	21,39
M10	1,50	80	24	10,00	8,00	4	68875	26,27
M12	1,75	89	29	9,00	7,10	4	68876	36,93
M14	2,00	95	30	11,20	9,00	4	68877	40,84
M16	2,00	102	32	12,50	10,00	4	68878	57,95



Ref. **3039**

MACHO ÚNICO MANO MÉTRICA / MÉTRICA FINA NORMA ISO

ISO Standard Metric / Metric Fine Hand Single Tap

Taraud à main unique métrique / métrique pas fin norme ISO

New!

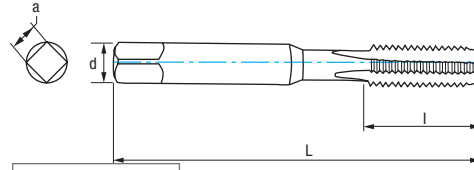

HSS
ISO 529
Tol. 6H

 α 10° ± 2

Nº3 Acabado Finishing Finition

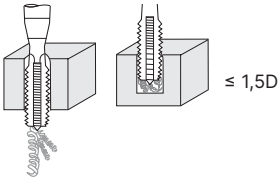

Grupo Group-Groupe **P**
Subgrup. P.1
Grupo Group-Groupe **K**
Grupo Group-Groupe **N**
Subgrup. N.1 - N.3 N.4 - N.5



M	P	L mm	l mm	d mm	a mm	Z	Nº Art.	€	Nº Art.	€	Nº Art.	€
M1	0,25	38,50	5,50	2,50	2,00	3	29121	21,31	29122	21,31	29123	21,31
M1,2	0,25	38,50	5,50	2,50	2,00	3	29124	21,31	29125	21,31	29126	21,31
M1,4	0,30	40,00	7,00	2,50	2,00	3	29127	21,31	29128	21,31	29129	21,31
M1,6	0,35	41,00	8,00	2,50	2,00	3	29130	19,45	29131	19,45	29132	19,45
M1,7	0,35	41,00	8,00	2,50	2,00	3	29133	12,28	29134	12,28	29159	12,28
M1,8	0,35	41,00	8,00	2,50	2,00	3	29160	18,25	29162	18,25	29164	18,25
M2	0,40	41,00	8,00	2,50	2,00	3	29171	9,68	29172	9,68	29175	9,68
M2	0,45	41,00	8,00	2,50	2,00	3	29176	9,68	29177	9,68	29193	9,68
M2,2	0,45	44,50	9,50	2,80	2,24	3	29195	10,09	29196	10,09	29197	10,09
M2,3	0,45	44,50	9,50	2,80	2,24	3	29199	10,09	29211	10,09	29212	10,09
M2,5	0,45	44,50	9,50	2,80	2,24	3	29214	9,68	29216	9,68	29217	9,68
M2,6	0,45	44,50	9,50	2,80	2,24	3	29218	8,91	29234	8,91	29277	8,91
MF3	0,35	48,00	11,00	3,15	2,50	3	45629	15,95	45644	15,95	45647	15,95
M3	0,60	48,00	11,00	3,15	2,50	3	29475	5,50	29477	5,50	29484	5,50
MF3,5	0,35	48,00	11,00	3,15	2,50	3	29494	10,55	29633	10,55	29846	10,55
M3,5	0,60	50,00	13,00	3,55	2,80	3	29861	6,50	29862	6,50	29865	6,50
MF4	0,50	53,00	13,00	4,00	3,15	3	45659	15,95	45662	15,95	45665	15,95
M4	0,70	53,00	13,00	4,00	3,15	3	29866	5,50	29867	5,50	29872	5,50
M4	0,75	53,00	13,00	4,00	3,15	3	29879	9,89	29886	9,89	29887	9,89
M4,5	0,75	53,00	13,00	4,00	3,15	3	29889	9,70	29890	9,70	29892	9,70
MF5	0,50	58,00	16,00	5,00	4,00	3	45668	16,86	45671	16,86	45698	16,86
MF5	0,75	58,00	16,00	5,00	4,00	3	45701	15,97	45705	15,97	45744	15,97
M5	0,80	58,00	16,00	5,00	4,00	3	29943	5,84	29948	5,84	29956	5,84
M5	0,90	58,00	16,00	5,00	4,00	3	29957	11,45	29966	11,45	29973	11,45
M5,5	0,90	62,00	12,00	5,60	4,50	3	29982	39,47	29983	39,47	29984	39,47
MF6	0,50	66,00	19,00	6,30	5,00	3	45819	11,60	45822	11,60	45845	11,60
MF6	0,75	66,00	19,00	6,30	5,00	3	45854	9,60	45856	9,60	45859	9,60
M6	1,00	66,00	19,00	6,30	5,00	3	29986	5,84	29987	5,84	30006	5,84
MF7	0,75	66,00	19,00	7,10	5,60	3	45869	14,62	45875	14,62	45878	14,62
M7	1,00	66,00	19,00	7,10	5,60	3	30007	7,13	30009	7,13	30010	7,13
MF8	0,50	66,00	19,00	8,00	6,30	3	45884	17,98	45890	17,98	45893	17,98
MF8	0,75	66,00	19,00	8,00	6,30	3	45902	14,24	45904	14,24	45917	14,24
MF8	1,00	66,00	19,00	8,00	6,30	3	45931	9,57	45934	9,57	45935	9,57
M8	1,25	66,00	19,00	8,00	6,30	3	30011	7,13	30013	7,13	30016	7,13
MF9	0,75	66,00	19,00	9,00	7,10	3					45936	16,23
MF9	1,00	72,00	22,00	9,00	7,10	3	45938	16,23	45939	16,23	45940	16,23
M9	1,25	72,00	22,00	9,00	7,10	3	30017	11,64	30018	11,64	30020	11,64
MF10	0,50	73,00	20,00	10,00	8,00	3					45942	20,74
MF10	0,75	73,00	20,00	10,00	8,00	3	46031	20,25	46034	20,25	46037	20,25
MF10	1,00	80,00	24,00	10,00	8,00	3	46040	10,29	46043	10,29	46046	10,29
MF10	1,25	80,00	24,00	10,00	8,00	3	46049	10,14	46052	10,14	46055	10,14
M10	1,50	80,00	24,00	10,00	8,00	3	30021	8,73	30063	8,73	30064	8,73
MF11	0,75	80,00	22,00	8,00	6,30	4	46058	50,02	46061	50,02	46067	50,02
MF11	1,00	80,00	22,00	8,00	6,30	4	46070	18,00	46075	18,00	46078	18,00
MF11	1,25	80,00	22,00	8,00	6,30	4					46089	18,15





M	P	L mm	I mm	d mm	a mm	Z	N° Art.	€	N° Art.	€	N° Art.	€
M11	1,50	80,00	22,00	8,00	6,30	4	30065	14,59	30066	14,59	30067	14,59
MF12	0,75	80,00	22,00	9,00	7,10	4					46091	28,81
MF12	1,00	80,00	22,00	9,00	7,10	4	46093	18,04	46095	18,04	46098	18,04
MF12	1,25	89,00	29,00	9,00	7,10	4	46101	18,07	46103	18,07	46104	18,07
MF12	1,50	89,00	29,00	9,00	7,10	4	46105	15,40	46155	15,40	46156	15,40
M12	1,75	89,00	29,00	9,00	7,10	4	30068	12,31	30069	12,31	30070	12,31
MF13	1,50	89,00	29,00	9,00	7,10	4					46158	29,20
MF14	1,00	87,00	22,00	11,20	9,00	4	46159	32,18	46161	32,18	46162	32,18
MF14	1,25	95,00	30,00	11,20	9,00	4	46164	22,05	46165	22,05	46167	22,05
MF14	1,50	95,00	30,00	11,20	9,00	4	46168	17,14	46169	17,14	46170	17,14
M14	2,00	95,00	30,00	11,20	9,00	4	30071	13,60	30072	13,60	30073	13,60
MF15	1,50	95,00	30,00	11,20	9,00	4			46171	41,73	46173	41,73
MF16	1,00	92,00	22,00	12,50	10,00	4	46176	37,25	46177	37,25	46178	37,25
MF16	1,25	102,00	32,00	12,50	10,00	4					46179	39,20
MF16	1,50	102,00	32,00	12,50	10,00	4	46180	21,44	46181	21,44	46182	21,44
M16	2,00	102,00	32,00	12,50	10,00	4	30074	19,29	30075	19,29	30076	19,29
MF18	1,00	97,00	22,00	14,00	11,20	4	46183	41,39	46184	41,39	46315	41,39
MF18	1,50	112,00	37,00	14,00	11,20	4	46327	28,33	46348	28,33	46525	28,33
MF18	2,00	112,00	37,00	14,00	11,20	4	46531	44,97	46540	44,97	46631	44,97
M18	2,50	112,00	37,00	14,00	11,20	4	30077	25,58	30078	25,58	30080	25,58
MF20	1,00	102,00	22,00	14,00	11,20	4	46901	55,13	46823	55,13	46898	55,13
MF20	1,50	112,00	37,00	14,00	11,20	4	46919	35,50	46925	35,50	46931	35,50
MF20	2,00	112,00	37,00	14,00	11,20	4	46940	46,61	46967	46,61	46976	46,61
M20	2,50	112,00	37,00	14,00	11,20	4	30082	28,80	30083	28,80	30085	28,80
MF22	1,00	118,00	38,00	16,00	12,50	4			46979	60,97	46982	60,97
MF22	1,50	118,00	38,00	16,00	12,50	4	46985	38,72	46988	38,72	46994	38,72
MF22	2,00	118,00	38,00	16,00	12,50	4	46997	62,01	47000	62,01	47006	62,01
M22	2,50	118,00	38,00	16,00	12,50	4	30086	38,53	30087	38,53	30088	38,53
MF24	1,00	130,00	45,00	18,00	14,00	4			47012	71,78	47015	71,78
MF24	1,50	130,00	45,00	18,00	14,00	4	47018	50,91	47021	50,91	47024	50,91
MF24	2,00	130,00	45,00	18,00	14,00	4	47027	68,75	47033	68,75	47036	68,75
M24	3,00	130,00	45,00	18,00	14,00	4	30089	45,16	30090	45,16	30091	45,16
MF25	1,50	130,00	45,00	18,00	14,00	4	47198	100,49	47273	100,49	47276	100,49
MF26	1,50	120,00	35,00	18,00	14,00	4			47279	77,78	47282	77,78
MF27	1,50	127,00	37,00	20,00	16,00	4			47288	86,20	47300	86,20
MF27	2,00	127,00	37,00	20,00	16,00	4					47435	118,80
M27	3,00	127,00	37,00	20,00	16,00	4	30092	58,14	30093	58,14	30111	58,14
MF28	1,50	127,00	37,00	20,00	16,00	4			47444	86,41	47453	86,41
MF30	1,50	127,00	37,00	20,00	16,00	4			47960	89,63	47963	89,63
MF30	2,00	127,00	37,00	20,00	16,00	4			47966	128,81	47969	128,81
M30	3,50	127,00	37,00	20,00	16,00	4	30112	74,44	30113	74,44	30115	74,44
MF32	1,50	137,00	37,00	22,40	18,00	4	48092	129,01	48095	129,01	48098	129,01
MF33	2,00	137,00	37,00	22,40	18,00	4			48104	144,57	48107	144,57
M33	3,50	137,00	37,00	22,40	18,00	4	30118	93,89	30120	93,89	30125	93,89
MF35	1,50	144,00	39,00	25,00	20,00	4			48110	145,92	48113	145,92
MF36	1,50	144,00	39,00	25,00	20,00	4					48140	140,93
MF36	2,00	144,00	39,00	25,00	20,00	4			48149	222,75	48152	222,75
MF36	3,00	144,00	39,00	25,00	20,00	4			48161	246,06	48164	246,06
M36	4,00	144,00	39,00	25,00	20,00	4	30126	119,80	30138	119,80	30145	119,80
MF39	3,00	170,00	60,00	28,00	22,40	4			48176	208,64	48188	208,64
M39	4,00	170,00	60,00	28,00	22,40	4	30146	134,04	30147	134,04	30148	134,04
MF40	1,50	149,00	39,00	28,00	22,40	4			48191	187,75	48194	187,75
MF42	1,50	149,00	39,00	28,00	22,40	4			48197	248,40	48200	248,40
MF42	3,00	149,00	39,00	28,00	22,40	4					48203	245,41
M42	4,50	149,00	39,00	28,00	22,40	4	30149	167,70	30150	167,70	30151	167,70
MF45	1,50	165,00	45,00	31,50	25,00	4			48206	280,64	48209	280,64
M45	4,50	165,00	45,00	31,50	25,00	4	30152	193,61	30430	193,61	30459	193,61
MF48	1,50	165,00	45,00	31,50	25,00	4					48212	316,29
MF48	2,00	165,00	45,00	31,50	25,00	4					48218	390,80
MF48	3,00	165,00	45,00	31,50	25,00	4					48224	353,71
M48	5,00	187,00	67,00	31,50	25,00	4	30487	233,10	30493	233,10	30494	233,10
MF50	1,50	165,00	45,00	31,50	25,00	4			48284	283,39	48287	283,39
M52	5,00	200,00	70,00	35,50	28,00	4					30495	282,96
M56	5,50	200,00	70,00	35,50	28,00	4					30500	436,73



Ref. **3039**

MACHO ÚNICO MANO MÉTRICA / MÉTRICA FINA NORMA ISO
 ISO Standard Metric / Metric Fine Hand Single Tap
 Taraud à main unique métrique / métrique pas fin norme ISO

New!

Ref. 3039 + 1015 Zirkonio



14 Pcs

Cont.	Nº Art. Zirkonio	€
Machos / Taps / Tarauds ISO 529: M3-M4-M5-M6-M8-M10-M12 	26020	76,02
Brocas / Drill Bits / Forets HSS: 2,5-3,3-4,2-5,0-6,8-8,5-10,2		



Ref. **3032**

JUEGO MACHOS MANO BSW (WHITWORTH)

BSW (Whitworth) Hand Tap Set

Jeu de tarauds à main BSW (Whitworth)

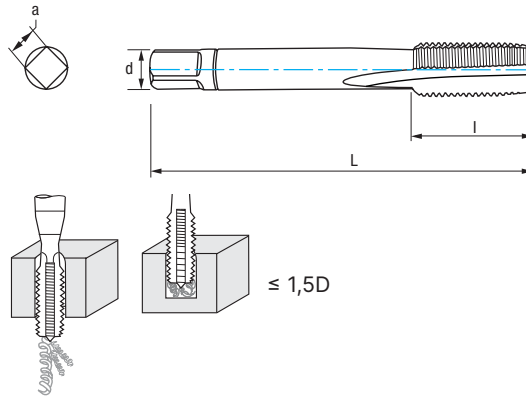

HSS	DIN 352	C 2-3h	α $10^\circ \pm 2$		Rosca Whitworth cilíndrica Straight Whitworth Thread Filetage Whitworth cylindrique
------------	---------	-----------	------------------------------	--	--

Aceros <math><850 \text{ N/mm}^2</math> Steel / Aciers	Fundición Cast Iron Fonte	Cobre Copper Cuivre	Aluminio Aluminium
---	--	----------------------------------	------------------------------

W	Hilos Threads Filets	L mm	l mm	d mm	a mm	Z	Nº Art.	€
W3/32	48,00	36	10	2,80	2,10	3	62663	28,15
W1/8	40,00	40	12	3,50	2,70	3	62642	22,91
W5/32	32,00	45	14	4,50	3,40	3	62675	22,91
W3/16	24,00	50	18	6,00	4,90	3	62660	22,91
W7/32	24,00	50	18	6,00	4,90	3	62684	34,63
W1/4	20,00	50	19	6,00	4,90	3	62633	26,06
W5/16	18,00	56	22	6,00	4,90	4	62669	31,02
W3/8	16,00	70	24	7,00	5,50	4	62654	34,33
W7/16	14,00	70	24	8,00	6,20	4	62681	44,96
W1/2	12,00	75	29	9,00	7,00	4	62630	49,67
W9/16	12,00	80	30	11,00	9,00	4	62687	67,11
W5/8	11,00	80	32	12,00	9,00	4	62666	77,63
W3/4	10,00	95	40	14,00	11,00	4	62645	110,49
W7/8	9,00	100	40	18,00	14,50	4	62678	137,22
W1"	8,00	110	50	18,00	14,50	4	62693	169,43
W1"1/8	7,00	132	56	22,00	18,00	4	62702	251,18
W1"1/4	7,00	132	56	22,00	18,00	4	62699	297,08
W1"3/8	6,00	150	63	28,00	22,00	4	42713	369,49
W1"1/2	6,00	150	63	32,00	24,00	4	62696	444,83
W1"5/8	5,00	160	70	32,00	24,00	4	59880	572,89
W1"3/4	5,00	160	70	36,00	29,00	6	59881	705,11
W1"7/8	4,50	190	80	36,00	29,00	6	59882	910,69
W2"	4,50	190	80	40,00	32,00	6	59883	956,04



Ref. **3012**

MACHO ÚNICO MANO BSW (WHITWORTH)

BSW (Whitworth) Hand Tap

Taraud à main BSW (Whitworth)

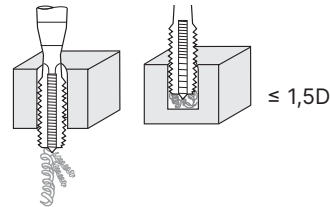
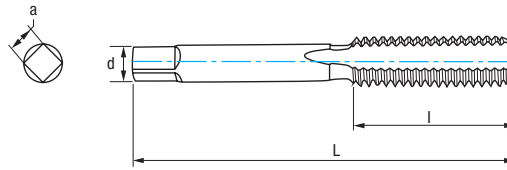

HSS

DIN 352

C
2-3h

α
 $10^\circ \pm 2$

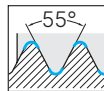

Rosca Whitworth cilíndrica
Straight Whitworth Thread
Filetage Whitworth cylindrique

Nº3 Acabado
Finishing
Finition

Aceros
<850 N/mm²
Steel / Aciers

Fundición
Cast Iron
Fonte

Cobre
Copper
Cuivre

Aluminio
Aluminium

W	Hilos Threads	Filets Filets	L mm	l mm	d mm	a mm	Z	Nº Art.	€
W3/32	48,00		40	9	2,80	2,10	3	75404	9,39
W1/8	40,00		40	14	3,50	2,70	3	75401	7,65
W5/32	32,00		45	17	4,50	3,40	3	75069	7,65
W3/16	24,00		50	19	6,00	4,90	3	74825	7,65
W7/32	24,00		50	19	6,00	4,90	3	75409	11,56
W1/4	20,00		50	20	6,00	4,90	3	75400	8,68
W5/16	18,00		56	20	6,00	4,90	4	75406	10,36
W3/8	16,00		63	22	7,00	5,50	4	75403	11,44
W7/16	14,00		70	22	8,00	6,20	4	75408	14,99
W1/2	12,00		75	25	9,00	7,00	4	75399	16,55
W9/16	12,00		80	26	11,00	9,00	4	75448	22,35
W5/8	11,00		80	27	12,00	9,00	4	75405	25,88
W3/4	10,00		95	32	14,00	11,00	4	75402	36,84
W7/8	9,00		100	32	18,00	14,50	4	75407	45,75
W1"	8,00		110	36	18,00	14,50	4	75410	56,48
W1" 1/8	7,00		125	40	22,00	18,00	4	76255	83,73
W1" 1/4	7,00		125	40	22,00	18,00	4	76259	100,83
W1" 3/8	6,00		150	50	28,00	22,00	4	76264	125,97
W1" 1/2	6,00		150	50	32,00	24,00	4	76269	151,69
W1" 5/8	5,00		150	56	32,00	24,00	4	76274	197,92
W1" 3/4	5,00		160	58	36,00	29,00	4	76280	243,49
W1" 7/8	4,50		180	65	36,00	29,00	4	76286	314,50
W2"	4,50		180	65	40,00	32,00	4	76291	330,17



Ref. **3026**

JUEGO MACHOS MANO BSP (GAS)

BSP (Gas) Hand Tap Set
Jeu tarauds à main BSP (Gaz)

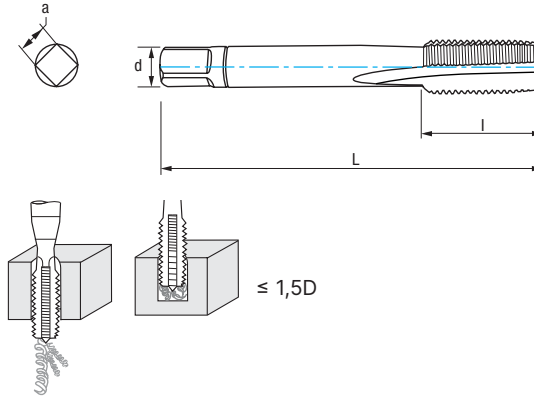

HSS	DIN 5157	ISO 2284	B 3,5-5h	C 2-3h		α $10^\circ \pm 2$		Rosca Whitworth Paralela (BSPP) Whitworth Parallel Thread (BSPP) Filetage Whitworth Parallèle (BSPP)
------------	----------	----------	-------------	-----------	--	------------------------------	--	---

Aceros <850 N/mm ² Steel / Aciers	Fundición Cast Iron Fonte	Cobre Copper Cuivre	Aluminio Aluminium
---	--	----------------------------------	------------------------------



DIN 5157	Nº1 Desbaste Roughing Ébauche	Nº3 Acabado Finishing Finition
----------	--	---

Nº1 **B**
3,5-5h

Nº3 **C**
2-3h

G	Hilos Threads Filets	L mm	I mm	d mm	a mm	Z	Nº Art.	€
G1/8	28	63	20	7,00	5,50	3	62510	23,49
G1/4	19	70	22	11,00	9,00	4	62504	33,05
G3/8	19	70	22	12,00	9,00	4	62516	40,61
G1/2	14	80	22	16,00	12,00	4	62498	58,27
G5/8	14	80	22	18,00	14,50	4	62522	74,52
G3/4	14	90	22	20,00	16,00	4	62513	90,97
G7/8	14	90	22	22,00	18,00	4	62525	121,34
G1"	11	100	25	25,00	20,00	4	62528	144,15
G1" 1/8	11	125	40	28,00	22,00	4	76195	225,77
G1" 1/4	11	125	40	32,00	24,00	4	76203	246,04
G1" 3/8	11	125	40	36,00	29,00	4	76211	334,18
G1" 1/2	11	140	40	36,00	29,00	6	74823	371,84
G1" 3/4	11	140	40	40,00	32,00	6	76225	618,17
G2"	11	160	40	45,00	35,00	8	76231	687,36

New!

ISO 2284	Nº3 Acabado Finishing Finition
----------	---

Nº3 **B**
3,5-5h

Nº3 **C**
2-3h

G	Hilos Threads Filets	L mm	I mm	d mm	a mm	Z	Nº Art.	€
G1/8	28	59	15	8,00	6,30	4	26780	20,67
G1/4	19	67	19	10,00	8,00	4	26789	29,08
G3/8	19	75	21	12,50	10,00	4	26814	36,53
G1/2	14	87	26	16,00	12,50	4	26830	51,27
G5/8	14	91	26	18,00	14,00	4	26845	65,57
G3/4	14	96	28	20,00	16,00	4	26852	80,06
G7/8	14	102	29	22,40	18,00	6	26857	106,78
G1"	11	109	33	25,00	20,00	6	26860	126,86
G1" 1/8	11	116	34	28,00	22,40	6	26891	198,68
G1" 1/4	11	119	36	31,50	25,00	6	26950	216,51
G1" 3/8	11	120	36	31,50	25,00	6	26954	294,08
G1" 1/2	11	125	37	35,50	28,00	6	26973	327,21
G1" 3/4	11	132	39	35,50	28,00	6	26988	544,00
G2"	11	140	41	40,00	31,50	6	27002	604,87



Ref. **3016**

MACHO ÚNICO MANO BSP (GAS)

BSP (Gas) Hand Tap
Taraud à main BSP (Gaz)

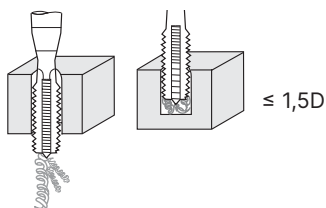
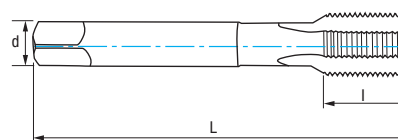

HSS

DIN 5157

ISO 2284



α
 $10^\circ \pm 2$

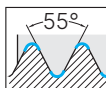

Rosca Whitworth Paralela (BSPP)
Whitworth Parallel Thread (BSPP)
Filetage Whitworth Parallèle (BSPP)

N°3 Acabado
Finishing
Finition

Aceros
<math><850 \text{ N/mm}^2</math>
Steel / Aciers

Fundición
Cast Iron
Fonte

Cobre
Copper
Cuivre

Aluminio
Aluminium



N°3



DIN 5157



G	Entrada Chamfer Entrée	Hilos Threads Filets	L mm	I mm	d mm	a mm	Z	N° Art.	€
G1/8		28	63	20	7,00	5,50	3	75461	11,77
G1/4		19	70	22	11,00	9,00	4	75460	16,53
G3/8		19	70	22	12,00	9,00	4	75462	20,77
G1/2		14	80	22	16,00	12,00	4	75459	29,12
G5/8		14	80	22	18,00	14,50	4	75463	37,26
G3/4		14	90	22	20,00	16,00	4	75106	45,47
G7/8		14	90	22	22,00	18,00	4	76246	60,67
G1"	C	11	100	25	25,00	20,00	4	75464	72,07
G1" 1/8		11	125	40	28,00	22,00	4	76196	112,89
G1" 1/4		11	125	40	32,00	24,00	4	76204	123,02
G1" 3/8		11	140	40	36,00	29,00	4	76212	167,09
G1" 1/2		11	140	40	36,00	29,00	6	76218	185,92
G1" 3/4		11	140	40	40,00	32,00	6	76226	309,09
G2"		11	160	40	45,00	35,00	8	76232	343,68

New!

ISO 2284



G	Entrada Chamfer Entrée	Hilos Threads Filets	L mm	I mm	d mm	a mm	Z	N° Art.	€
G1/8	B	28	59	15	8,00	6,30	4	26759	10,33
G1/8	C	28	59	15	8,00	6,30	4	26779	10,33
G1/4	B	19	67	19	10,00	8,00	4	26781	14,54
G1/4	C	19	67	19	10,00	8,00	4	26783	14,54
G3/8	B	19	75	21	12,50	10,00	4	26790	18,26
G3/8	C	19	75	21	12,50	10,00	4	26791	18,26
G1/2	B	14	87	26	16,00	12,50	4	26823	25,64
G1/2	C	14	87	26	16,00	12,50	4	26827	25,64
G5/8	B	14	91	26	18,00	14,00	4	26832	32,79
G5/8	C	14	91	26	18,00	14,00	4	26843	32,79
G3/4	B	14	96	28	20,00	16,00	4	26849	40,03
G3/4	C	14	96	28	20,00	16,00	4	26850	40,03
G7/8	B	11	102	29	22,40	18,00	6	26853	53,39
G7/8	C	11	102	29	22,40	18,00	6	26855	53,39
G1"	B	11	109	33	25,00	20,00	6	26858	63,42
G1"	C	11	109	33	25,00	20,00	6	26859	63,42
G1" 1/8	B	11	116	34	28,00	22,40	6	26862	99,34
G1" 1/8	C	11	116	34	28,00	22,40	6	26873	99,34
G1" 1/4	B	11	119	36	31,50	25,00	6	26941	108,26
G1" 1/4	C	11	119	36	31,50	25,00	6	26948	108,26
G1" 3/8	B	11	120	36	31,50	25,00	6	26951	147,04
G1" 3/8	C	11	120	36	31,50	25,00	6	26953	147,04
G1" 1/2	B	11	125	37	35,50	28,00	6	26956	163,61
G1" 1/2	C	11	125	37	35,50	28,00	6	26971	163,61
G1" 3/4	B	11	132	39	35,50	28,00	6	26974	272,00
G1" 3/4	C	11	132	39	35,50	28,00	6	26976	272,00
G2"	B	11	140	41	40,00	31,50	8	26991	302,44
G2"	C	11	140	41	40,00	31,50	8	26997	302,44

N°3



Ref. **3100**

MACHO RECTO MÁQUINA MÉTRICA MANGO REFORZADO

Reinforced Shank Metric Machine Straight Tap
Taraud droit machine métrique queue renforcée

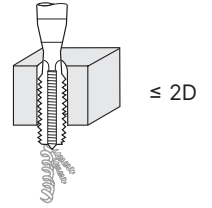
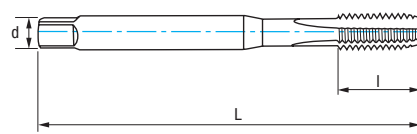

HSSE
5% Co

DIN
371

Reforzado
Reinforced
Renforcée



Tol.
6H

α
 $10^\circ \pm 2$

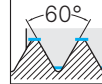

Aceros
<math><850 \text{ N/mm}^2</math>
Steel / Aciers

Cobre
Copper
Cuivre

Aluminio
Aluminium



M	P	L mm	l mm	d mm	a mm	Z	Nº Art.	€
M2	0,40	45	9	2,80	2,10	3	62771	16,80
M2,5	0,45	50	9	2,80	2,10	3	76724	16,80
M2,6	0,45	50	9	2,80	2,10	3	76725	16,80
M3	0,50	56	11	3,50	2,70	3	62774	9,53
M3,5	0,60	56	13	4,00	3,00	3	62777	15,10
M4	0,70	63	13	4,50	3,40	3	62780	10,07
M4,5	0,75	70	16	6,00	4,90	3	76728	22,87
M5	0,80	70	16	6,00	4,90	3	62783	10,07
M6	1,00	80	19	6,00	4,90	3	62789	11,07
M7	1,00	80	19	7,00	5,50	3	76733	17,51
M8	1,25	90	22	8,00	6,20	3	62795	12,38
M9	1,25	90	18	9,00	7,00	3	62798	20,68
M10	1,50	100	24	10,00	8,00	3	62807	15,24



Expo 25 Pcs

Cont. Ø	Nº Art.	€
Machos / Taps / Tarauds DIN 371: M4-M5-M6-M8- M10 (5 pcs x M)	38998	294,15

Set Ref. 3100

7 Pcs



Cont. Ø	Nº Art.	€
Machos / Taps / Tarauds DIN 371: M3-M4-M5- M6-M8-M10 + DIN 376: M12	43348	87,65

Set Ref. 3100 + 1010 HSS

14 Pcs



Cont. Ø	Nº Art.	€
Machos / Taps / Tarauds DIN 371: M3-M4-M5- M6-M8-M10 + DIN 376: M12 Brocas / Drill Bits / Forets HSS: 2,5-3,3-4,2-5,0- 6,8-8,5-10,2	43354	100,93

Set Ref. 3100 + 1016 HSSE

14 Pcs



Cont. Ø	Nº Art.	€
Machos / Taps / Tarauds DIN 371: M3-M4-M5- M6-M8-M10 + DIN 376: M12 Brocas / Drill Bits / Forets HSSE: 2,5-3,3-4,2-5,0- 6,8-8,5-10,2	21801	112,18

Set Ref. 3100 + 1015 Zirkonio

14 Pcs



New!

Cont. Ø	Nº Art.	€
Machos / Taps / Tarauds DIN 371: M3-M4-M5- M6-M8-M10 + DIN 376: M12 Brocas / Drill Bits / Forets HSS: 2,5-3,3-4,2-5,0- 6,8-8,5-10,2	56424	112,82



Ref. **3200**

MACHO RECTO MÁQUINA MÉTRICA/ MÉTRICA FINA

Metric / Metric Fine Machine Straight Tap

Taraud droit machine métrique / métrique pas fin

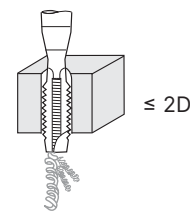
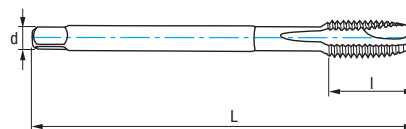

HSSE
5% Co

M
DIN
376

MF
DIN
374

B
3,5-5h

GUN

Tol.
6H

α
 $10^\circ \pm 2$

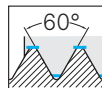

Aceros
<math><850 \text{ N/mm}^2</math>
Steel / Aciers

Cobre
Copper
Cuivre

Aluminio
Aluminium



M/MF	P	L mm	l mm	d mm	a mm	Z	Nº Art.	€
M3	0,50	56	11	2,20			70090	10,18
M4	0,70	63	13	2,80	2,10	3	70092	10,31
M5	0,80	70	16	3,50	2,70	3	70093	10,31
M6	1,00	80	19	4,50	3,40	3	70095	11,32
M7	1,00	80	19	5,50	4,30	3	70224	17,98
MF8	0,75	80	19	6,00	4,90	3	70267	26,22
MF8	1,00	90	22	6,00	4,90	3	70248	21,26
M8	1,25	90	22	6,00	4,90	3	70096	12,71
MF10	1,00	90	20	7,00	5,50	3	70249	23,69
MF10	1,25	100	24	7,00	5,50	3	70251	28,24
M10	1,50	100	24	7,00	5,40	3	70098	15,66
M11	1,50	100	24	8,00	6,20	3	70225	30,21
MF12	1,00	100	22	9,00	7,00	3	70252	31,20
MF12	1,25	100	22	9,00	7,00	3	70254	31,51
MF12	1,50	100	22	9,00	7,00	3	70255	28,15
M12	1,75	110	29	9,00	7,00	3	70183	19,29
MF14	1,00	100	22	11,00	9,00	3	70281	47,83
MF14	1,25	100	22	11,00	9,00	3	70257	41,92
MF14	1,50	100	22	11,00	9,00	3	70258	33,32
M14	2,00	110	30	11,00	9,00	3	70185	30,94
MF15	1,50	100	22	12,00	9,00	3	70282	53,11
MF16	1,50	100	22	12,00	9,00	3	70260	41,65
M16	2,00	110	32	12,00	9,00	3	70186	36,42
MF18	1,00	110	25	14,00	11,00	3	70284	66,64
MF18	1,50	110	25	14,00	11,00	3	70261	52,11
MF18	2,00	125	34	14,00	11,00	3	70285	67,25
M18	2,50	125	34	14,00	11,00	3	75215	51,57
MF20	1,00	125	25	16,00	12,00	3	70287	87,95
MF20	1,50	125	25	16,00	12,00	3	70263	58,92
MF20	2,00	140	34	16,00	12,00	3	70288	77,27
M20	2,50	140	34	16,00	12,00	3	70189	55,76
MF22	1,50	125	25	18,00	14,50	3	75216	70,99
MF22	2,00	140	34	18,00	14,50	3	70290	112,50

M/MF	P	L mm	l mm	d mm	a mm	Z	Nº Art.	€
M22	2,50	140	34	18,00	14,50	3	70212	67,45
MF24	1,50	140	28	18,00	14,50	4	70264	87,27
MF24	2,00	140	28	18,00	14,50	4	70291	110,31
M24	3,00	160	38	18,00	14,50	4	70213	80,20
MF26	1,50	140	28	18,00	14,50	4	70293	112,15
MF27	2,00	140	28	20,00	16,00	4	70294	152,97
M27	3,00	160	38	20,00	16,00	4	70215	100,50
MF28	1,50	140	28	20,00	16,00	4	70296	128,27
MF30	1,50	150	28	22,00	18,00	4	70266	133,96
M30	3,50	180	45	22,00	18,00	4	70216	129,14
MF32	1,50	150	28	22,00	18,00	4	70297	160,33
MF33	1,50	160	30	25,00	20,00	4	70299	183,30
MF33	2,00	160	30	25,00	20,00	4	70300	264,84
M33	3,50	180	50	25,00	20,00	4	70218	162,43
MF35	1,50	170	30	28,00	22,00	4	70302	212,34
MF36	1,50	170	30	28,00	22,00	4	81355	235,39
MF36	2,00	170	30	28,00	22,00	4	81356	235,59
MF36	3,00	200	42	28,00	22,00	4	81357	270,27
M36	4,00	200	56	28,00	22,00	4	70219	198,44
MF39	1,50	170	30	32,00	24,00	4	81358	266,03
MF39	2,00	170	30	32,00	24,00	4	81359	236,05
MF39	3,00	200	42	32,00	24,00	4	81360	227,43
M39	4,00	200	50	32,00	24,00	4	81361	222,36
MF42	1,50	170	30	32,00	24,00	4	81362	249,45
MF42	2,00	170	30	32,00	24,00	4	81363	244,53
MF42	3,00	200	50	32,00	24,00	4	81364	378,90
M42	4,50	200	56	32,00	24,00	4	14886	285,86
MF45	1,50	180	32	36,00	29,00	6	70303	372,05
M45	4,50	220	56	36,00	29,00	6	81365	361,06
M48	5,00	250	63	36,00	29,00	6	81366	518,44
M52	5,00	250	63	40,00	32,00	6	81367	583,24
M56	5,50	250	65	40,00	32,00	6	81368	638,78
M60	5,50	280	75	45,00	35,00	6	81369	678,89



Expo 25 Pcs

Cont.	Nº Art.	€
Machos / Taps / Tarauds DIN 376: M4-M5-M6-M8- M10 (5 pcs x M)	39000	301,55



Ref. **3150**

MACHO HELICOIDAL MÁQUINA MÉTRICA MANGO REFORZADO

Reinforced Shank Metric Machine Spiral Tap

Taroud hélicoïdal machine métrique queue renforcée

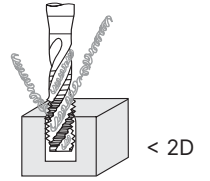
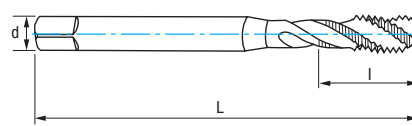

HSSE 5% Co	DIN 371	Reforzado Reinforced Renforcée	C 2-3h	35°	α 10° ± 2	60°
----------------------	------------	---	-----------	-----	--------------	-----

Aceros <850 N/mm ² Steel / Aciers	Cobre Copper Cuivre	Aluminio Aluminium
---	----------------------------------	------------------------------



M	P	L mm	l mm	d mm	a mm	Z	Nº Art.	€
M3	0,50	56	5	3,50	2,70	3	63050	12,57
M3,5	0,60	56	6	4,00	3,00	3	63053	18,48
M4	0,70	63	7	4,50	3,40	3	63056	12,57
M5	0,80	70	8	6,00	4,90	3	63059	11,99
M6	1,00	80	10	6,00	4,90	3	63062	13,16
M7	1,00	80	10	7,00	5,50	3	63065	20,52
M8	1,25	90	13	8,00	6,20	3	63071	15,05
M9	1,25	90	13	9,00	7,00	3	67882	25,65
M10	1,50	100	15	10,00	8,00	3	63083	17,84



Expo 25 Pcs

Cont. Ø	Nº Art.	€
Machos / Taps / Tarauds DIN 371: M4-M5-M6-M8- M10 (5 pcs x M)	38999	353,05

Set Ref. 3150

7 Pcs



Cont. Ø	Nº Art.	€
Machos / Taps / Tarauds DIN 371: M3-M4-M5- M6-M8-M10 + DIN 376: M12	43353	106,05



Set Ref. 3150 + 1010 HSS

14 Pcs

Cont. Ø	Nº Art.	€
Machos / Taps / Tarauds DIN 371: M3-M4-M5- M6-M8-M10 + DIN 376: M12	43359	119,33
Brocas / Drill Bits / Forets HSS: 2,5-3,3-4,2-5,0- 6,8-8,5-10,2		

Set Ref. 3150 + 1016 HSSE

14 Pcs



Cont. Ø	Nº Art.	€
Machos / Taps / Tarauds DIN 371: M3-M4-M5- M6-M8-M10 + DIN 376: M12	21802	130,58
Brocas / Drill Bits / Forets HSSE: 2,5-3,3-4,2-5,0- 6,8-8,5-10,2		

Set Ref. 3150 + 1015 Zirkonio

14 Pcs



Cont. Ø	Nº Art.	€
Machos / Taps / Tarauds DIN 371: M3-M4-M5- M6-M8-M10 + DIN 376: M12	56428	131,22
Brocas / Drill Bits / Forets HSSE: 2,5-3,3-4,2-5,0- 6,8-8,5-10,2		



Ref. **3250**

MACHO HELICOIDAL MÁQUINA MÉTRICA / MÉTRICA FINA

Metric / Metric Fine Machine Spiral Tap

Taraud hélicoïdal machine métrique / métrique pas fin

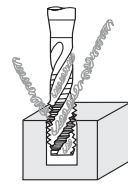
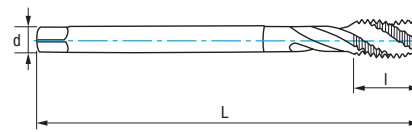

< 2D

HSSE 5% Co	M DIN 376	MF DIN 374	C 2-3h	Tol. 6H		$10^\circ \pm 2$	
----------------------	-----------------	---------------	-----------	------------	--	------------------	--

Aceros <850 N/mm ² Steel / Aciers	Cobre Copper Cuivre	Aluminio Aluminium
---	----------------------------------	------------------------------



M/MF	P	L mm	l mm	d mm	a mm	Z	Nº Art.	€
M3	0,50	56	5	2,20		3	70063	12,25
M4	0,70	63	7	2,80	2,10	3	70065	12,15
M5	0,80	70	8	3,50	2,70	3	70066	11,64
M6	1,00	80	10	4,50	3,40	3	70068	12,75
MF8	1,00	90	13	6,00	4,90	3	70228	25,21
M8	1,25	90	13	6,00	4,90	3	70069	14,96
MF10	1,00	90	12	7,00	5,50	3	70230	29,72
MF10	1,25	100	15	7,00	5,50	3	70231	32,35
M10	1,50	100	15	7,00	5,50	3	70071	17,78
MF12	1,00	100	14	9,00	7,00	3	70233	36,92
MF12	1,25	100	14	9,00	7,00	3	70234	35,33
MF12	1,50	100	14	9,00	7,00	3	70236	33,99
M12	1,75	110	18	9,00	7,00	3	70161	22,87
MF14	1,25	100	16	11,00	9,00	3	70237	52,19
MF14	1,50	100	16	11,00	9,00	3	70239	41,79
M14	2,00	110	20	11,00	9,00	3	70162	35,89
MF16	1,50	100	16	12,00	9,00	3	70240	51,37
M16	2,00	110	20	12,00	9,00	4	70164	43,35
MF18	1,50	110	20	14,00	11,00	4	70242	62,05
M18	2,50	125	25	14,00	11,00	4	75057	58,38
MF20	1,50	125	20	16,00	12,00	4	70243	70,86
M20	2,50	140	25	16,00	12,00	4	70167	62,15
MF22	1,50	125	20	18,00	14,50	4	75192	92,75
M22	2,50	140	25	18,00	14,50	4	70206	76,67
MF24	1,50	140	22	18,00	14,50	4	70245	103,89
MF24	2,00	140	28	18,00	14,50	4	24326	109,05
M24	3,00	160	30	18,00	14,50	4	70207	91,77
New! MF27	2,00	140	28	20,00	16,00	4	71566	171,98
M27	3,00	160	30	20,00	16,00	4	70209	114,65
MF30	1,50	150	28	22,00	18,00	4	70246	159,74
M30	3,50	180	35	22,00	18,00	4	70210	146,85



Expo 25 Pcs

Cont. Ø	Nº Art.	€
Machos / Taps / Tarauds DIN 376: M4-M5-M6-M8- M10 (5 pcs x M)	39001	346,40



Ref. **3119**

MACHO RECTO MÁQUINA MÉTRICA NORMA ISO 529

ISO 529 Norm Standard Metric Machine Straight Tap

Taraud droit machine métrique norme ISO 529

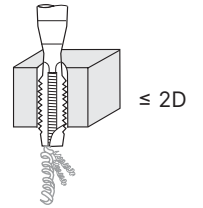
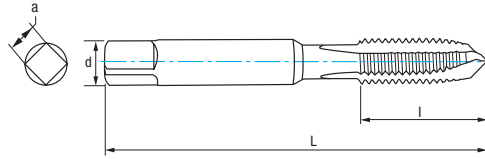

HSSE 5% Co	ISO 529	B 3,5-5h	Tol. 6H	GUN	α $10^\circ \pm 2$	60°	Vaporizado Vaporized Vaporisée
----------------------	-------------------	--------------------	------------	------------	------------------------------	------------	---

Aceros <math><850 \text{ N/mm}^2</math> Steel / Aciers	INOX Stainless Steel Acier INOX	Cobre Copper Cuivre	Aluminio Aluminium
---	--	----------------------------------	------------------------------



	M	P	L mm	l mm	d mm	a mm	Z	Nº Art.	€
New!	M2	0,40	41	8	2,50	2,00	2	77478	15,03
New!	M2,5	0,45	44	9,5	2,80	2,24	2	77479	15,03
	M3	0,50	48	11	3,15	2,50	3	69558	8,51
New!	M3,5	0,60	53	13	4,00	3,15	3	69562	13,48
	M4	0,70	53	13	4,00	3,15	3	69567	8,51
New!	M4,5	0,75	58	16	5,00	4,00	3	69570	13,48
	M5	0,80	58	16	5,00	4,00	3	69575	8,51
	M6	1,00	66	19	6,30	5,00	3	69582	8,51
New!	M7	1,00	66	19	6,30	5,00	3	69583	16,05
	M8	1,25	72	22	8,00	6,30	3	69586	12,50
	M10	1,50	80	24	10,00	8,00	3	69588	15,01
	M12	1,75	89	29	9,00	7,10	3	69607	19,27
	M14	2,00	95	30	11,20	9,00	3	69608	25,02
	M16	2,00	102	32	12,50	10,00	3	69610	34,98
	M18	2,50	112	37	14,00	11,20	3	69611	45,87
	M20	2,50	112	37	14,00	11,20	3	69613	61,75
	M22	2,50	118	38	16,00	12,50	3	69614	74,77
	M24	3,00	130	45	18,00	14,00	3	69616	98,56
	M27	3,00	135	45	20,00	16,00	3	69617	121,40
	M30	3,50	138	48	20,00	16,00	3	69619	156,44

Línea 33 cm - Ref. 3119

26 cm



\varnothing	M3	M5	M6	M8	M10
Pcs	3	3	3	3	3

Ref. 4995 - Nº Art. 70993: 159,12 €



Ref. **3113**

MACHO HELICOIDAL MÁQUINA MÉTRICA NORMA ISO 529

ISO 529 Standard Metric Machine Spiral Tap

Taraud hélicoïdal machine métrique norme ISO 529

New!

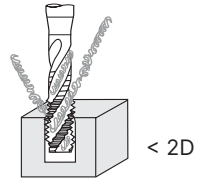
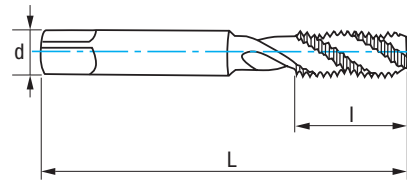

HSSE
5% Co

ISO
529



Tol.
6H



α
12-14°



Vaporizado
Vaporized
Vaporisée

Aceros
<850 N/mm²
Steel / Aciers

Cobre
Copper
Cuivre

Aluminio
Aluminium



M	P	L mm	l mm	d mm	a mm	Z	N° Art.	€
M2	0,40	41	8	2,50	2,00	2	48989	17,64
M2,5	0,45	44	9,5	2,80	2,24	2	48992	17,64
M3	0,50	48	6	3,15	2,50	3	49004	10,01
M3,5	0,60	50	6	3,55	2,80	3	49016	15,86
M4	0,70	53	7	4,00	3,15	3	49019	10,01
M5	0,80	58	8	5,00	4,00	3	49022	10,01
M6	1,00	66	10	6,30	5,00	3	49025	10,01
M7	1,00	66	13	7,10	5,60	3	49028	18,89
M8	1,25	72	12	8,00	6,30	3	49031	13,36
M10	1,50	80	15	10,00	8,00	3	49034	17,00
M12	1,75	89	16	9,00	7,10	3	49187	21,87
M14	2,00	95	18	11,20	9,00	3	49190	27,82
M16	2,00	102	18	12,50	10,00	4	49193	38,86
M18	2,50	112	29	14,00	11,20	4	49196	51,01
M20	2,50	112	29	14,00	11,20	4	49199	68,61
M22	2,50	118	29	16,00	12,50	4	49202	83,09
M24	3,00	130	35	18,00	14,00	4	49205	109,51
M27	3,00	135	35	20,00	16,00	4	77480	137,23
M30	3,50	138	42	20,00	16,00	4	77481	176,17



Ref. **3109**

MACHO RECTO MÁQUINA MÉTRICA NORMA ISO 529

ISO 529 Norm Standard Metric Machine Straight Tap

Taraud droit machine métrique norme ISO 529

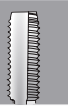
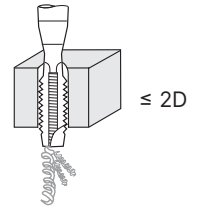
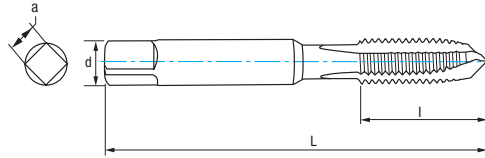

HSS	ISO 529	B 3,5-5h	Tol. 6H	GUN	α $10^\circ \pm 2$	60°
-----	---------	-------------	------------	-----	------------------------------	-----

Aceros
<850 N/mm²
Steel / Aciers

Cobre
Copper
Cuivre

Aluminio
Aluminium



New!

M	P	L mm	l mm	d mm	a mm	Z	Nº Art.	€	Nº Art. TIN	€
M3	0,50	48	11	3,15	2,50	3	38180	7,40	31717	10,23
M3,5	0,60	53	13	4,00	3,15	3	38181	11,71	70208	14,88
M4	0,70	53	13	4,00	3,15	3	38182	7,40	31718	10,46
M4,5	0,75	58	16	5,00	4,00	3	38183	11,71	70229	14,88
M5	0,80	58	16	5,00	4,00	3	38373	7,40	31719	10,46
M6	1,00	66	19	6,30	5,00	3	38185	7,40	31720	10,46
M7	1,00	66	19	6,30	5,00	3	38186	11,98	70235	15,88
M8	1,25	72	22	8,00	6,30	3	38187	9,88	31721	13,78
M10	1,50	80	24	10,00	8,00	3	38188	12,57	31722	18,65
M12	1,75	89	29	9,00	7,10	3	38189	16,14	31729	22,78
M14	2,00	95	30	11,20	9,00	3	38190	19,30	31730	27,23
M16	2,00	102	32	12,50	10,00	3	38191	23,97	31732	33,62
M18	2,50	112	37	14,00	11,20	3	38192	36,08	31734	46,29
M20	2,50	112	37	14,00	11,20	3	38193	40,33	31736	52,63
M22	2,50	118	38	16,00	12,50	3	38194	46,63	31737	60,85
M24	3,00	130	45	18,00	14,00	3	38195	52,68	31746	67,99
M27	3,00	135	45	20,00	16,00	3	38196	64,88	31747	107,32
M30	3,50	138	48	20,00	16,00	3	38197	96,40	31748	138,83
New! M33	3,50	151	51	22,40	18,00	4	31585	120,79	31749	163,22
New! M36	4,00	162	57	25,00	20,00	4	31588	147,57	31751	197,50
New! M39	4,00	170	60	28,00	22,40	4	31605	165,36	31752	215,29
New! M42	4,50	170	60	28,00	22,40	4	31607	212,58	31753	271,99
New! M45	4,50	187	67	31,50	25,00	4	31609	268,51	31754	327,92
New! M48	5,00	187	67	31,50	25,00	4	31616	385,55	31755	448,95



Línea 33 cm - Ref. 3109 -1-



∅	M3	M5	M6	M8	M10
Pcs	3	3	3	3	3

Ref. 4995 - N° Art. 71560: 133,95 €

Línea 33 cm - Ref. 3109 -2-



∅	M12	M14	M16	M18	M20
Pcs	3	3	3	3	3

Ref. 4995 - N° Art. 71563: 407,46 €



Ref. **3157**

MACHO HELICOIDAL MÁQUINA MÉTRICA NORMA ISO 529

ISO 529 Norm Standard Metric Machine Spiral Tap

Taraud hélicoïdal machine métrique norme ISO 529

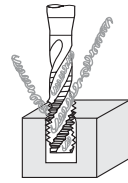
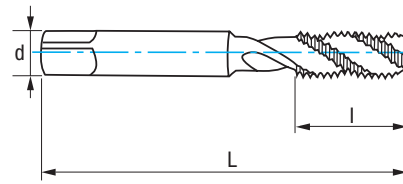

< 2D



HSS

ISO 529



Tol. 6H

α 12-14°



Aceros
 <850 N/mm²
 Steel / Aciers

Cobre
 Copper
 Cuivre

Aluminio
 Aluminium



New!

M	P	L mm	l mm	d mm	mm	Z	Nº Art.	€	Nº Art. TIN	€
M3	0,50	48	11	3,15	2,50	3	38198	8,91	31723	11,74
M3,5	0,60	53	13	4,00	3,15	3	38199	14,11	70194	17,28
M4	0,70	53	13	4,00	3,15	3	38201	8,91	31724	12,08
M5	0,80	58	16	5,00	4,00	3	38206	8,91	31725	12,08
M6	1,00	66	19	6,30	5,00	3	38209	9,11	12168	12,28
M7	1,00	66	19	6,30	5,00	3	38211	14,43	70197	18,33
M8	1,25	72	22	8,00	6,30	3	38214	10,21	31726	14,11
M10	1,50	80	24	10,00	8,00	3	38216	13,15	31728	19,24
M12	1,75	89	29	9,00	7,10	3	38226	17,10	31756	23,74
M14	2,00	95	30	11,20	9,00	3	38228	23,37	31757	31,30
M16	2,00	102	32	12,50	10,00	3	38229	27,11	31758	36,76
New! M18	2,50	112	37	14,00	11,20	4	31627	40,81	31759	51,02
New! M20	2,50	118	38	16,00	12,50	4	31629	45,62	31760	57,92
New! M22	2,50	130	45	18,00	14,00	4	31630	52,74	31761	66,96
New! M24	3,00	135	45	20,00	16,00	4	31634	59,53	31762	86,41
New! M27	3,00	138	48	20,00	16,00	4	31635	73,32	31763	115,75
New! M30	3,50	151	51	22,40	18,00	4	31638	108,93	31764	151,37
New! M33	3,50	162	57	25,00	20,00	4	31586	136,50	31766	178,93
New! M36	4,00	170	60	28,00	22,40	4	31604	167,14	31767	217,07
New! M39	4,00	170	60	28,00	22,40	4	31606	187,28	31768	237,22
New! M42	4,50	187	67	31,50	25,00	4	31608	240,77	31769	300,18
New! M45	4,50	187	67	31,50	25,00	4	31612	304,12	31772	363,53
New! M48	5,00	187	67	31,50	25,00	4	31620	436,68	31775	500,08



Línea 33 cm - Ref. 3157 -1-

26
cm



∅	M3	M5	M6	M8	M10
Pcs	3	3	3	3	3

Ref. 4995 - N° Art. 70997: 150,87 €

Línea 33 cm - Ref. 3157 -2-

26
cm



∅	M12	M14	M16
Pcs	3	3	3

Ref. 4995 - N° Art. 72127: 202,74 €



Ref. **3103**

MACHO RECTO MÁQUINA UNC NORMA ISO 529

ISO 529 Norm Standard UNC Machine Straight Tap

Taraud droit machine UNC norme ISO 529

New!

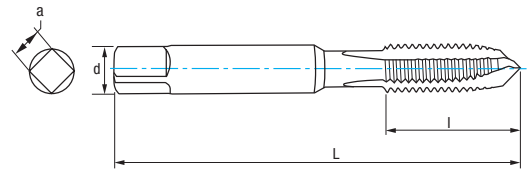

HSS	ISO 529	B 3,5-5h	C 2-3h	Tol. 6H	GUN	α 10-12°	60°
-----	---------	-------------	-----------	------------	-----	--------------------	-----

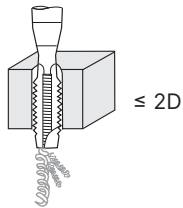

UNC	Hilos Threads	Filets	L mm	l mm	d mm	a mm	Z	N° Art.	€	N° Art.	€
UNC N°1	64		41	8	2,50	2,00	3	62989	20,45	62990	20,45
UNC N°2	56		45	10	2,80	2,24	3	62991	20,45	62992	20,45
UNC N°3	48		45	10	2,80	2,24	3	62994	20,45	62995	20,45
UNC N°4	40		48	11	3,15	2,50	3	62996	20,45	62997	20,45
UNC N°5	40		48	11	3,15	2,50	3	62998	19,56	62999	19,56
UNC N°6	32		50	13	3,55	2,80	3	63000	17,62	63001	17,62
UNC N°8	32		53	13	4,50	3,55	3	63003	17,62	63004	17,62
UNC N°10	24		58	16	5,00	4,00	3	63006	18,50	63007	18,50
UNC N°12	24		62	17	5,60	4,50	3	63009	17,65	63012	17,65
UNC 1/4	20		66	19	6,30	5,00	3	63016	13,93	63018	13,93
UNC 5/16	18		72	22	8,00	6,30	3	63019	18,93	63021	18,93
UNC 3/8	16		80	24	10,00	8,00	3	63022	21,12	63027	21,12
UNC 7/16	14		85	25	8,00	6,30	3	63028	29,96	63030	29,96
UNC 1/2	13		89	29	9,00	7,10	3	63031	33,33	63033	33,33
UNC 9/16	12		95	30	11,20	9,00	3	63034	33,85	63036	33,85
UNC 5/8	11		102	32	12,50	10,00	3	63038	34,77	63039	34,77
UNC 3/4	10		112	37	14,00	11,20	3	63040	48,89	63042	48,89
UNC 7/8	9		118	38	16,00	12,50	3	63043	66,48	63045	66,48
UNC 1"	8		130	45	18,00	14,00	3	63046	79,31	63047	79,31
UNC 1"1/8	7		138	48	20,00	16,00	4	63048	103,67	63049	103,67
UNC 1"1/4	7		151	51	22,40	18,00	4	63051	146,36	63052	146,36
UNC 1"3/8	6		162	57	25,00	20,00	4	63054	195,07	63057	195,07
UNC 1"1/2	6		170	60	28,00	22,40	4	63058	219,43	63060	219,43
UNC 1"3/4	5		187	67	31,50	25,00	4	63061	329,17	63063	329,17
UNC 2"	4		200	70	35,50	28,00	4	63064	414,40	63066	414,40



Ref. **3123**

MACHO RECTO MÁQUINA UNF NORMA ISO 529

ISO 529 Norm Standard UNF Machine Straight Tap

Taraud droit machine UNF norme ISO 529

New!

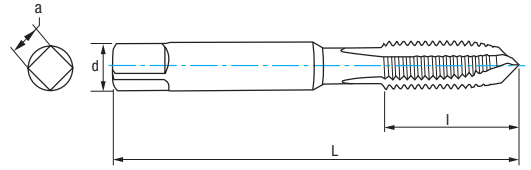

HSS	ISO 529	B 3,5-5h	C 2-3h	Tol. 6H	GUN	α 10-12°	60°
-----	---------	-------------	-----------	------------	-----	--------------------	-----

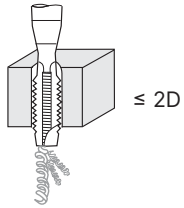

UNF	Hilos Threads	Filets	L mm	l mm	d mm	a mm	Z	N° Art.	€	N° Art.	€
UNF N°0	80		41	8	2,50	2,00	3	63067	16,19	66203	16,19
UNF N°1	72		41	8	2,50	2,00	3	63069	16,19	66205	16,19
UNF N°2	64		45	10	2,80	2,24	3	63070	16,19	66398	16,19
UNF N°3	56		45	10	2,80	2,24	3	84231	16,19	84232	16,19
UNF N°4	48		48	11	3,15	2,50	3	63072	16,19	66410	16,19
UNF N°5	44		48	11	3,15	2,50	3	63075	15,49	66413	15,49
UNF N°6	40		50	13	3,55	2,80	3	63076	13,25	66509	13,25
UNF N°8	36		53	13	4,50	3,55	3	63079	13,25	66512	13,25
UNF N°10	32		58	16	5,00	4,00	3	63112	13,73	66566	13,73
UNF N°12	28		62	17	5,60	4,50	3	63171	14,74	66596	14,74
UNF 1/4	28		66	19	6,30	5,00	3	63172	13,33	66722	13,33
UNF 5/16	24		72	22	8,00	6,30	3	63173	17,90	66728	17,90
UNF 3/8	24		80	24	10,00	8,00	3	63174	18,87	67163	18,87
UNF 7/16	20		85	25	8,00	6,30	3	63175	27,71	67169	27,71
UNF 1/2	20		89	29	9,00	7,10	3	63177	29,53	67349	29,53
UNF 9/16	18		95	30	11,20	9,00	3	63180	27,01	67358	27,01
UNF 5/8	18		102	32	12,50	10,00	3	63181	32,07	67359	32,07
UNF 3/4	16		112	37	14,00	11,20	3	63184	43,67	67361	43,67
UNF 7/8	14		118	38	16,00	12,50	3	63213	50,32	67364	50,32
UNF 1"	12		130	45	18,00	14,00	3	63326	59,88	67370	59,88
UNF 1"1/8	12		127	37	20,00	16,00	4	63389	80,26	67373	80,26
UNF 1"1/4	12		137	37	22,40	18,00	4	63392	113,31	67376	113,31
UNF 1"3/8	12		144	39	25,00	20,00	4	63446	151,03	67394	151,03
UNF 1"1/2	12		149	39	28,00	22,40	4	64121	169,89	67403	169,89



Ref. **3500**

COJINETE MANO MÉTRICA / MÉTRICA FINA

Metric / Metric Fine Hand Die

Filière à main métrique / métrique pas fin



HSS

DIN 223

Tol. 6g

α 10-17°

Chafilán Entrada 1,75h
Chamfer 1,75 Threads
Chanfrein 1,75 filets

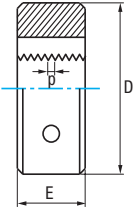
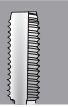

M/MF	P	D mm	E mm	N° Art.	€
M2	0,40	16	5	63191	26,01
M2,5	0,45	16	5	75001	26,01
M3	0,50	20	5	63194	22,02
M3,5	0,60	20	5	63197	26,01
MF4	0,50	20	5	77025	35,78
M4	0,70	20	5	63200	22,02
M4,5	0,75	20	7	77028	24,03
MF5	0,50	20	5	77029	38,42
M5	0,80	20	7	63203	22,02
MF6	0,50	20	5	77034	38,42
MF6	0,75	20	7	77035	34,51
M6	1,00	20	7	63206	22,02
MF7	0,75	25	9	77037	24,32
M7	1,00	25	9	63209	24,03
MF8	0,50	25	9	77038	37,41
MF8	0,75	25	9	77039	37,41
MF8	1,00	25	9	63212	37,41
M8	1,25	25	9	63215	24,03
MF9	1,00	25	9	77041	41,62
M9	1,25	25	9	63218	32,01
MF10	0,75	30	11	77043	58,21
MF10	1,00	30	11	63221	45,75
MF10	1,25	30	11	63224	49,65
M10	1,50	30	11	63227	32,01
MF11	1,00	30	11	77045	56,93
MF11	1,25	30	11	77046	62,08
M11	1,50	30	11	63230	42,02
MF12	1,00	38	10	63233	57,89
MF12	1,25	38	10	63236	57,89
MF12	1,50	38	10	63239	51,75
M12	1,75	38	14	63242	34,01
MF13	1,00	38	10	77049	48,47
MF13	1,50	38	10	77050	50,96
MF14	1,00	38	10	63251	59,39
MF14	1,25	38	10	63254	63,26
MF14	1,50	38	10	63257	54,09
M14	2,00	38	14	63260	34,01
MF15	1,00	38	10	75307	55,13
MF15	1,50	38	10	77053	74,14
MF16	1,00	45	14	63266	80,33
MF16	1,25	45	14	77054	52,00
MF16	1,50	45	14	63269	74,28
M16	2,00	45	18	63272	46,01
MF18	1,00	45	14	77057	84,01
MF18	1,25	45	14	77058	67,99
MF18	1,50	45	14	63278	74,28
MF18	2,00	45	14	63281	84,01
M18	2,50	45	18	63284	46,01
MF20	1,00	45	14	77061	83,64
MF20	1,50	45	14	63287	76,66
MF20	2,00	45	14	63290	84,23

M/MF	P	D mm	E mm	N° Art.	€
M20	2,50	45	18	63293	46,01
MF22	1,00	55	16	77066	114,22
MF22	1,50	55	16	63296	98,28
MF22	2,00	55	16	63299	109,32
M22	2,50	55	22	63302	68,04
MF24	1,00	55	16	77069	109,32
MF24	1,50	55	16	77070	98,28
MF24	2,00	55	16	63308	109,33
M24	3,00	55	22	63311	68,04
MF25	1,00	55	16	77072	147,34
MF25	1,50	55	16	77073	133,57
MF26	1,00	55	16	77075	159,51
MF26	1,50	55	16	77076	135,15
MF27	1,00	65	18	70103	117,21
MF27	1,50	65	18	77656	148,59
MF27	2,00	65	18	77079	161,62
M27	3,00	65	25	63314	102,04
MF28	1,50	65	18	77081	105,80
MF30	1,00	65	18	77082	124,23
MF30	1,50	65	18	77083	148,55
MF30	2,00	65	18	75310	165,91
M30	3,50	65	25	63317	102,04
MF32	1,50	65	18	77085	157,01
MF33	1,50	65	18	77088	148,59
MF33	2,00	65	18	77089	115,21
M33	3,50	65	25	77090	106,06
MF35	1,50	65	18	77093	160,79
MF36	1,50	65	18	75311	152,19
MF36	2,00	65	18	77095	161,79
MF36	3,00	65	25	77096	123,85
M36	4,00	65	25	77097	106,06
New! MF39	1,50	75	20	84227	172,80
New! MF39	2,00	75	20	84228	182,47
New! MF39	3,00	75	30	84229	207,36
M39	4,00	75	30	77103	162,05
MF40	1,50	75	20	77104	240,13
MF40	2,00	75	20	77105	173,95
MF40	3,00	75	30	70104	189,73
MF42	2,00	75	20	77108	257,68
MF42	3,00	75	30	70106	239,49
M42	4,50	75	30	77110	162,05
MF45	1,50	90	22	77112	315,76
MF45	2,00	90	22	77113	266,48
MF45	3,00	90	36	77114	278,02
M45	4,50	90	36	77115	254,09
MF48	1,50	90	22	70107	239,90
MF48	3,00	90	36	35159	251,32
M48	5,00	90	36	77119	254,09
MF50	1,50	90	22	77120	315,76
MF52	1,50	90	22	77121	315,76
M52	5,00	90	36	77124	254,09



Set - Ref. 3500



7 Pcs

Cont. Ø	Nº Art.	€
Cojinetes / Dies / Filières DIN 223: M3-M4-M5-M6- M8-M10-M12	56518	178,13

Línea 33 cm - Ref. 3500



20
cm

Ø	M4	M5	M6	M8	M10	M12
Pcs	2	2	2	2	2	2

Ref. 4995 - Nº Art. 71001: 312,22 €



Ref. **3005**

TERRAJA MONOBLOCK METAL

METAL Monoblock Die
Filière monoblock MÉTAL

DISEÑO
EXCLUSIVO!
IZAR
CUTTING TOOLS



HSS	DIN 223		Tol. 6g	α 10-17°	Con Guía Guided Avec Guide
------------	---------	--	---------	-----------------	---

M	P	D mm	Nº Art.	€
M3	0,50	20	25226	22,39
M4	0,70	20	25227	22,39
M5	0,80	20	25228	22,39
M6	1,00	20	25229	22,81
M8	1,25	25	25231	24,04
M10	1,50	30	25233	31,71
M12	1,75	38	25581	33,68



Display 43 - Ref. 3005



Ref. 3005	Ø	M-4	M-5	M-6	M-8	M-10	M-12
Pcs		2	2	2	2	2	2

Ref. 4995 - Nº Art. 32964: **314,04 €**

Ref. **3006**

JUEGO TERRAJAS MONOBLOCK Y MACHOS MANO

Monoblock Die & Hand Tap Set
Jeu filières monoblock & tarauds à main

30 Pcs

Cont.	Nº Art.	€	
Juegos Machos Tap Sets / Jeux Tarauds	M3 - M4 - M5- M6 - M8 - M10 - M12	78141	175,51
Terrajas / Dies / Filières Monoblock Ref. 3005	M3 - M4 - M5- M6 - M8 - M10 - M12		
Gira-Machos Tap-Wrench / Porte-Tarauds	M1 - M12		
Galga Gauge / Gabarit	1 pc		



Ref. **3536**

COJINETE MANO MÉTRICA / MÉTRICA FINA INOX

Stainless Metric / Metric Fine Hand Die
Filière à main métrique / métrique pas fin inox



HSSE 5% Co	DIN 22568		Tol. 6g	α 20°	Vaporizado Vaporized Vaporisée
Aceros Steels Aciers	INOX Stainless Steel Acier INOX		Chafilán Entrada 2,25h Chamfer 2,25 Threads Chanfrein 2,25 filets		

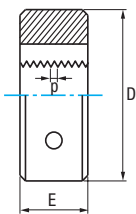

M	P	D mm	E mm	N° Art.	€
M3	0,50	20	5	34255	24,22
M4	0,70	20	5	34256	24,22
M5	0,80	20	7	34257	24,22
M6	1,00	20	7	34258	24,44
M7	1,00	25	9	55515	26,33
M8	1,25	25	9	34259	26,33
MF10	0,75	30	11	81370	63,96
MF10	1,00	30	11	81371	50,27
MF10	1,25	30	11	81372	54,56
M10	1,50	30	11	34260	35,22
MF12	1,00	38	10	81373	63,61
MF12	1,25	38	10	81374	63,61
MF12	1,50	38	10	81375	56,87
M12	1,75	38	14	34261	45,52
MF14	1,00	38	10	81376	65,26
MF14	1,50	38	10	81377	59,43
M14	2,00	38	14	34262	45,52
MF15	1,00	38	10	81378	60,57
MF16	1,00	45	14	81379	95,31

M	P	D mm	E mm	N° Art.	€
MF16	1,50	45	14	81380	86,03
M16	2,00	45	18	34263	63,12
MF17	1,00	45	14	81381	76,23
MF18	1,00	45	14	81382	92,32
MF18	1,50	45	14	81383	81,63
MF18	2,00	45	14	81384	92,32
M18	2,50	45	18	34264	63,12
MF20	1,00	45	14	81385	91,91
MF20	1,50	45	14	81386	84,24
MF20	2,00	45	14	81387	92,57
M20	2,50	45	18	34265	63,12
MF22	1,00	55	16	81388	136,88
MF22	1,50	55	16	81389	125,00
MF22	2,00	55	16	81390	136,88
M22	2,50	55	22	81391	119,15
MF24	1,50	55	16	81392	125,00
M24	3,00	55	22	81393	119,15
M27	3,00	65	25	81394	184,43
M30	3,50	65	25	81395	192,26
M33	3,50	65	25	83117	230,75



Set 7 Pcs

Cont.	N° Art.	€
Cojinetes / Dies / Filières DIN 223: M3-M4-M5-M6-M8-M10-M12	76494	204,17

Línea 33 cm - Ref. 3536



∅	M4	M5	M6	M8	M10	M12
Pcs	2	2	2	2	2	2

Ref. 4995 - N° Art. 71005: 359,90 €



Ref. **3510**

COJINETE MANO MÉTRICA ISO

ISO Metric Hand Die
Filière à main métrique ISO



HSS

ISO
529

Tol.
6g

α
10-17°

Forma
A
Form

Ajustable
BS 1127 A
Adjustable

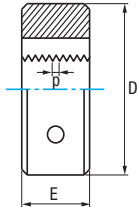

M	P	D mm	E mm	N° Art.	€
M3	0,50	25,4	9,5	38230	8,50
M4	0,70	25,4	9,5	38231	8,50
M5	0,80	25,4	9,5	38232	8,50
M6	1,00	25,4	9,5	38233	8,50
M7	1,00	25,4	9,5	38234	9,96
M8	1,25	25,4	9,5	38235	8,97
M10	1,50	25,4	9,5	38237	11,43
M12	1,75	25,4	9,5	38238	11,43

M	P	D mm	E mm	N° Art.	€
M8	1,25	38,1	12,7	38239	26,58
M10	1,50	38,1	12,7	38240	27,70
M12	1,75	38,1	12,7	38242	27,70
M14	2,00	38,1	12,7	38243	27,70
M16	2,00	38,1	12,7	38244	27,70
M18	2,50	38,1	12,7	38245	40,97
M20	2,50	38,1	12,7	38246	40,97



M	P	D mm	E mm	N° Art.	€
M18	2,50	50,8	15,9	38250	49,83
M20	2,50	50,8	15,9	38251	49,83
M22	2,50	50,8	15,9	38252	49,83
M24	3,00	50,8	15,9	38253	52,05

Línea 33 cm - Ref. 3510

16
cm



ø	M4×25,4	M5×25,4	M6×25,4	M8×25,4	M10×25,4	M12×25,4
Pcs	2	2	2	2	2	2

Ref. 4995 - N° Art. 72129: 114,66 €



COJINETES HEXAGONALES

Hexagon Die Nuts
Filières hexagonales

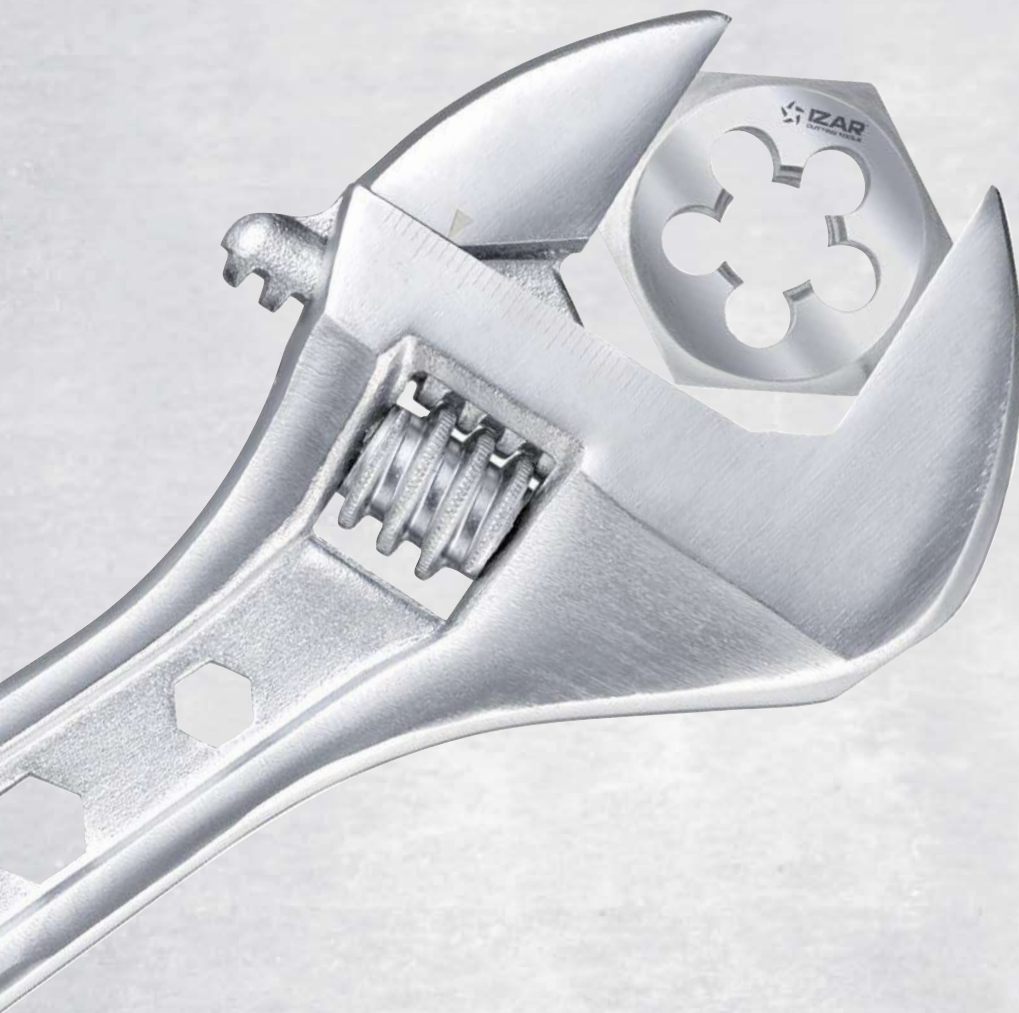

Los cojinetes hexagonales se utilizan para trabajos de montaje y repasado de roscas con resistencia a la tracción baja y media. Las medidas clave estandarizadas del hexágono permiten el uso de llaves ajustables y llaves fijas como herramientas de trabajo.

Hexagon Die Nuts are used for assembly works and re-cutting of threads with low and medium tensile strength. The standardized key metrics of the hexagon enable the usage of ring wrenches and open-end wrenches as operating tools.

Les filières hexagonales sont utilisées pour les travaux hors atelier et pour retoucher des filetages avec une résistance à la traction faible/moyenne. Les mesures entre les faces de l'hexagone permettent l'utilisation de clés réglables et de clés fixes standard comme outils de serrage.

Ref. **3560**

COJINETE MANO HEXAGONAL MÉTRICA / MÉTRICA FINA

Metric / Metric Fine HEX Hand Die

Filière à main hexagonale métrique / métrique pas fin

New!

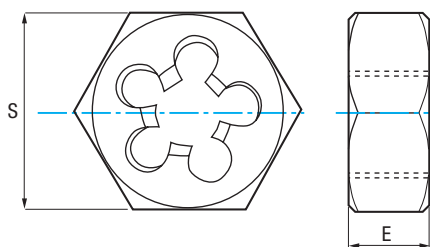

HSS	DIN 382		Tol. 6g
-----	---------	--	---------

M/MF	P	S mm	E mm	N° Art.	€
MF3	0,35	19	5	84244	36,48
M3	0,50	19	5	84245	22,45
M3,5	0,60	19	5	84246	26,51
MF4	0,50	19	5	84247	36,48
M4	0,70	19	5	84248	22,45
M4,5	0,75	19	7	84249	24,50
MF5	0,50	19	7	84250	39,17
M5	0,80	19	7	84251	22,45
MF6	0,75	19	7	84252	39,17
M6	1,00	19	7	84253	22,45
MF7	0,75	22	9	84254	24,79
M7	1,00	22	9	84255	24,50
MF8	0,75	22	9	84256	38,03
MF8	1,00	22	9	84259	38,03
M8	1,25	22	9	84260	24,50
MF9	1,00	22	9	84261	42,43
M9	1,25	22	9	84262	32,63
MF10	1,00	27	11	84263	46,64
M10	1,50	27	11	84264	32,63
MF11	1,00	27	11	84266	58,03
M11	1,50	27	11	84267	42,84
MF12	1,00	36	10	84268	52,75
MF12	1,25	36	10	84269	59,01
MF12	1,50	36	10	84270	59,01
M12	1,75	36	14	84271	34,67
MF14	1,00	36	10	84272	55,14
MF14	1,25	36	10	84273	64,49
MF14	1,50	36	10	84274	60,54
M14	2,00	36	14	84275	34,67
MF16	1,50	41	14	84276	75,73

M/MF	P	S mm	E mm	N° Art.	€
M16	2,00	41	18	84277	46,90
MF18	1,50	41	14	84278	75,73
MF18	2,00	41	14	84279	85,64
M18	2,50	41	18	84281	46,90
MF20	1,50	41	14	84283	78,15
MF20	2,00	41	14	84282	85,26
M20	2,50	41	18	84284	46,90
MF22	1,50	50	16	84285	100,19
MF22	2,00	50	16	84286	111,45
M22	2,50	50	16	84287	69,36
MF24	1,50	50	16	84288	100,19
MF24	2,00	50	16	84289	111,46
M24	3,00	50	22	84290	69,36
MF26	1,50	60	18	84291	137,77
MF27	1,50	60	18	84292	151,47
MF27	2,00	60	18	84293	164,76
M27	3,00	60	25	84294	104,02
MF28	1,50	60	18	84295	107,86
MF30	1,50	60	18	84296	151,43
MF30	2,00	60	18	84297	169,13
M30	3,50	60	25	84298	104,02
MF32	1,50	60	18	84299	160,06
MF33	1,50	60	18	84300	151,47
MF33	2,00	60	18	84301	117,44
M33	3,50	60	25	84302	108,12
MF35	1,50	60	18	84303	163,92
MF36	1,50	60	18	84304	155,15
MF36	2,00	60	18	84305	164,93
MF36	3,00	60	18	84306	126,25
M36	4,00	60	25	84307	108,12



- | | | |
|--|---|---|
| <ul style="list-style-type: none"> • Para uso con llave fija, ajustable o de vaso • Ideal para espacios limitados • Recomendado para reparar roscas | <ul style="list-style-type: none"> • For use with a fixed, extendable, or socket wrench • Ideal for tight spaces • Recommended for rethreading threads | <ul style="list-style-type: none"> • Pour une utilisation avec une clé fixe, une clé extensible ou à douille • Idéal pour les espaces restreints • Recommandé pour réparer les filetages |
|--|---|---|



Ref. **3502**

COJINETE MANO WHITWORTH

Whitworth Hand Die
Filière à main Whitworth



HSS

DIN
223

α
10-17°

Chaflán Entrada 1,75h
Chamfer 1,75 Threads
Chanfrein 1,75 Filets

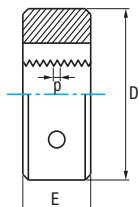

W	Hilos Threads Filets	D mm	E mm	Nº Art.	€	W	Hilos Threads Filets	D mm	E mm	Nº Art.	€
W3/32	48	16	5	63344	35,74	W7/16	14	30	11	63362	43,56
W1/8	40	20	5	63329	28,87	W1/2	12	38	14	63320	43,56
W5/32	32	20	7	63356	30,07	W9/16	12	38	14	63368	52,16
W3/16	24	20	7	63341	30,07	W5/8	11	45	18	63347	63,37
W7/32	24	20	7	63365	39,42	W3/4	10	45	18	63332	63,37
W1/4	20	20	7	63323	28,87	W7/8	9	55	22	63359	93,18
W5/16	18	25	9	63350	30,07	W1"	8	55	22	63374	93,18
W3/8	16	30	11	63335	43,56	W1" 1/8	7	65	25	63383	146,66

Ref. **3546**

COJINETE MANO BSP (GAS) INOX

Stainless BSP (Gas) Hand Die
Filière à main BSP (Gaz) Inox



HSSE
5% Co

DIN
24231



Tol.
A

α
20°

Chaflán Entrada 2,25h
Chamfer 2,25 Threads
Chanfrein 2,25 filets

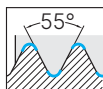

Rosca británica para tubo **paralelo** (BSPP-GAS)
British Standard **Parallel** Pipe (BSPP-GAS)
Filetage britannique pour tuyau **parallèle** (BSPP-GAS)

Vaporizado
Vaporized
Vaporisée

Aceros
Steels
Aciers

INOX
Stainless Steel
Acier INOX

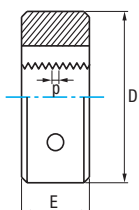

G	Hilos Threads Filets	D mm	E mm	Nº Art.	€
G1/8	28	30	11	81341	41,93
G1/4	19	38	10	81342	41,93
G3/8	19	45	14	81343	56,95
G1/2	14	45	14	81344	56,95
G3/4	14	55	16	81345	111,90
G1"	11	65	18	81346	171,02



Ref. **3506**

COJINETE MANO BSP (GAS)

BSP (Gas) Hand Die
Filière à main BSP (Gaz)



HSS	DIN 24231	α 10-17°	Chaflán Entrada 1,75h Chamfer 1,75 Threads Chanfrein 1,75 filets	Vaporizado Vaporized Vaporisée
------------	-----------	--------------------	---	---

 **Rosca británica para tubo paralelo (BSPP-GAS)**
British Standard **Parallel** Pipe (BSPP-GAS)
Filetage britannique pour tuyau **parallèle** (BSPP-GAS)

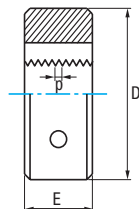

G	Hilos Threads Filets	D mm	E mm	Nº Art.	€
G1/8	28	30	11	63461	38,12
G1/4	19	38	10	63455	38,12
G3/8	19	45	14	63467	49,30
G1/2	14	45	14	63452	49,30
G5/8	14	55	16	75496	75,23
G3/4	14	55	16	63464	102,18
G7/8	14	65	18	76252	106,96
G1"	11	65	18	63470	106,96
G1" 1/8	11	75	20	76202	195,90
G1" 1/4	11	75	20	76210	195,90
G1" 1/2	11	90	22	76224	195,90
New! G1" 3/4	11	105	22	76230	201,59
New! G2"	11	105	22	76236	242,61



Ref. **3191**

GIRA-MACHOS

Tap Wrench
Porte-taroud



DIN
1814



Mod.	Uso Use Usage	L mm	Cuadradillo Square / Carré mm	Nº Art.	€
000	M1-M8	125	2,10-4,90	69826	15,59
010	M1-M10	180	2,10-5,50	69828	16,29
015	M1-M12	200	2,10-7,00	69829	17,78
020	M4-M12	280	3,40-7,00	69831	22,73
030	M5-M20	375	4,90-12,00	69832	31,77

Mod.	Uso Use Usage	L mm	Cuadradillo Square / Carré mm	Nº Art.	€
040	M11-M27	500	6,20-16,00	69834	50,38
050	M13-M32	750	7,00-20,00	69835	104,24
* 060	M18-M42	870	7,00-28,00	83111	119,30
* 070	M25-M52	1250	16,00-32,00	26694	200,48
(New!) * 080	M25-M75	1015	14,50-40,00	24537	213,27

* Acero / Steel / Acier

Línea 33 cm - Ref. 3191



Mod.	000	010	015	020	030
Pcs	2	2	2	2	2

Ref. 4995 - Nº Art. 80556: 208,32 €

Ref. **3912**

GIRA-MACHOS CRIQUÉ

Tap Wrench
Porte-taroud



"T" +
Criqué



Mod.	M	L mm	Cap. mm	Nº Art.	€
01	M3-M10	85	2,4-5,5	25340	23,05
02	M5-M12	100	4,5-8,0	25341	31,31
10	M3-M10	250	2,4-5,5	25342	36,35
20	M5-M12	300	4,5-8,0	25343	43,35

Línea 33 cm - Ref. 3912



Mod.	01	02	10	20
Pcs	2	2	2	2

Ref. 4995 - Nº Art. 72135: 268,12 €



Ref. **3181**

PORTA-COJINETES

Die Holder
Porte filières



DIN
225



Mod.	D mm	E mm	L mm	M/MF	W	G	N° Art.	€
000	16	5	160	M1-M2,6	W1/16-W3/32		69792	8,72
010	20	5	200	M3-M4	W1/8-W5/32		69790	9,47
020	20	7	200	M4,5-M6	W3/16-W1/4		69798	9,47
030	25	9	224	M7-M9	W5/16	G1/16	69799	10,87
040	30	11	280	M10-M11	W3/8-W7/16	G1/8	69811	13,47
050	38	14	315	M12-M15	W1/2-W9/16		69813	17,10
060	38	10	315	MF12-MF15		G1/4	69814	17,10
070	45	18	450	M16-M20	W5/8-W3/4		69816	21,16
080	45	14	450	MF16-MF20		G3/8-G1/2	69817	21,16
090	55	22	560	M22-M24	W7/8-W1		69819	28,42
100	55	16	560	MF21-MF26		G5/8-G3/4	69795	27,07
110	65	25	630	M27-M36	W1 1/8 - W1 3/8		69796	39,88
120	65	18	630	MF27-MF36		G7/8-G1	30484	39,88
* 130	75	30	920	M39-M42	W1 1/2 - W1 5/8		32600	124,04
* 140	75	20	920	MF38-MF42		G1 1/8 - G1 1/4	43515	124,04
* 150	90	36	950	M45-M52	W1 3/4 - W2		43516	180,77
* 160	90	22	950	MF45-MF52		G1 1/2	43517	180,77

* Acero / Steel / Acier

Ref. **3184**

PORTA-COJINETES ISO 529

ISO 529 Die Holder
Porte filières ISO 529



DIN
225

D mm	E mm	M	W	N° Art.	€
25,40	9,50	M3-M12	W1/8-W1/2	43317	11,32
38,10	12,70	M8-M20	W5/16-W3/4	43318	16,91
50,80	15,90	M18-M24	W11/16-W1	43319	24,44



Ref. **3900**

GALGA

Pitch Gauge
Jauge



Cap. M	Cap. W	N° Art.	€
0,25-6,00	4G-62G	44612	8,13
0,40-6,00		67641	3,14



Ref. **3405**

JUEGO MACHOS MANO MÉTRICA

Metric Hand Tap Set
Jeu de tarauds à main métrique

Set 29 Pcs

Cont.	N° Art.	€
Juegos Machos / Tap Sets / Jeux Tarauds M3-M4-M5-M6-M8-M10-M12		
Brocas / Drill Bits / Forets mm 2,5-3,3-4,2-5,0-6,8-8,5-10,2	69624	105,11
Gira-Machos / Tap-Wrench / Porte-Tarauds M1-M12		



Ref. **3404**

JUEGO MACHOS MANO PERFIL ROSCA COMPLETA

Whole Thread Profile Hand Tap Set
Jeu de tarauds à main profil filetage complet

Set 15 Pcs

Cont.	N° Art.	€
Machos / Taps / Tarauds M3-M4-M5-M6-M8-M10-M12		
Brocas / Drill Bits / Forets mm 2,5-3,3-4,2-5,0-6,8-8,5-10,2	68214	86,46
Gira-Machos / Tap-Wrench / Porte-Tarauds M1-M12		



Ref. **3406**

JUEGO MACHOS Y COJINETES MANO MÉTRICA

Metric Hand Tap & Die Set
Jeu de tarauds et filières à main métrique



New! ISO

33 Pcs

Mod. 0 - Cont.

Juegos Machos Tap Sets / Jeux Tarauds	M3-M4-M5-M6-M8-M10-M12
Gira-Machos Tap-Wrench / Porte-Tarauds	M1-M12
Gira-Machos Tap-Wrench / Porte-Tarauds	Criqué M3-M10 Ratchet
Cojinetes Dies / Filières	M3-M4-M5-M6-M8-M10-M12
Porta-Cojinetes Die Holder / Porte-Filières	25x9
Galga Gauge / Gabarit	1 pc
Destornillador Screwdriver / Tournevis	1 pc



N° Art.	€
70527	133,61



N° Art.	€
18959	182,52

55 Pcs

Mod. 1 - Cont.

	N° Art.	€	
Juegos Machos Tap Sets / Jeux Tarauds	M3-M4-M5-M6-M8-M10-M12-M14-M16-M18-M20	38404	399,59
Gira-Machos Tap-Wrench / Porte-Tarauds	M1-M12, M5-M20		
Gira-Machos Tap-Wrench / Porte-Tarauds	Criqué M3-M10 + M5-M12 Ratchet		
Cojinetes Dies / Filières	M3-M4-M5-M6-M8-M10-M12-M14-M16-M18-M20		
Porta-Cojinetes Die Holder / Porte-Filières	20x5, 20x7, 25x9, 30x11, 38x14, 45x18		
Galga Gauge / Gabarit	1 pc		
Destornillador Screwdriver / Tournevis	1 pc		



45 Pcs

Mod. 2 - Cont.

	N° Art.	€	
Juegos Machos Tap Sets / Jeux Tarauds	M3-M4-M5-M6-M8-M10-M12	38981	195,99
Gira-Machos Tap-Wrench / Porte-Tarauds	M1-M10, M4-M12		
Gira-Machos Tap-Wrench / Porte-Tarauds	Criqué M3-M10 Ratchet		
Cojinetes Dies / Filières	M3-M4-M5-M6-M8-M10-M12		
Porta-Cojinetes Die Holder / Porte-Filières	20x5, 20x7, 25x9, 30x11, 38x14		
Galga Gauge / Gabarit	1 pc		
Destornillador Screwdriver / Tournevis	1 pc		
Brocas Drill Bits / Forets mm	2,5-3,3-4,2-5,0-6,8-8,5-10,2		

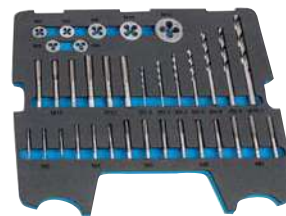

Ref. **9016**

BROCA METAL DURO DESTRUCTORA MACHOS

Tap Destroyer Solid Carbide Drill Bit
Foret carbure destructeur de tarauds

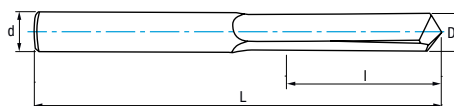

MD / HM
Carbure
Grano UF

IZAR
Std.



HRC
50-65

To.
h6

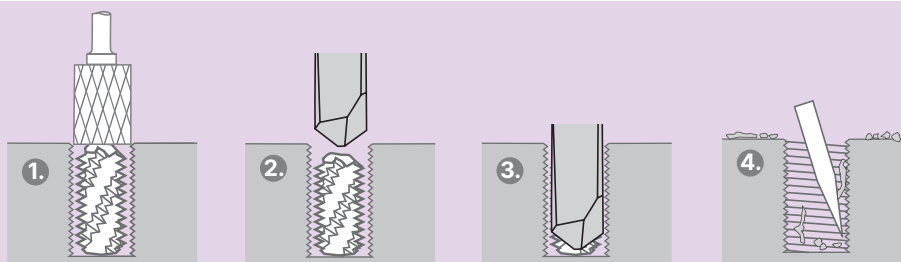

PROCEDIMIENTO PARA QUITAR MACHOS ROTOS:

1. Macho roto

Si sobresale alguna parte del macho roto, alisarla para poder taladrarlo más fácilmente.

2. Centrado de la broca

Colocar la broca sobre el centro del macho, fijando bien tanto la pieza de trabajo como la misma broca.

Sin lubricante, hacer un taladrado inicial de aproximación y retraer la broca rápidamente.

3. Proceso de taladrado

Taladrar a velocidad y avance fijos, y con parones para evacuar la viruta. Utilizar lubricación.

4. Sustraer el macho roto

Sustraer los restos del macho roto con un buril o instrumento similar.

PROCEDURE FOR REMOVING BROKEN TAPS:

1. Broken Tap

If any part of the broken tap is protruding, grind the surface in order to make it flat.

2. Centering of the Drill

Position the drill bit on the center of the broken tap. Please make sure that both the workpiece and the tap are firmly secured. Make an initial drill approach and retract the drill bit quickly. Don't use any lubrication.

3. Drilling

Drill the hole at a fixed speed and feed, stopping the process occasionally to remove the broken chips. Use lubrication in this step.

4. Chip Removal

The parts of the broken tap can be removed using a scribe or a similar tool.

PROCÉDURE POUR ENLEVER LES TARAUDS CASSÉS :

1. Taraud cassé

Si une partie du taraud dépasse, lissez la surface endommagée du taraud au ras de la pièce pour la percer plus facilement.

2. Centrage du foret

Placez le foret au centre du taraud. Assurez-vous que la pièce et le foret sont correctement centrés. Faites un premier perçage d'approximation, puis rétractez rapidement le foret. Pour cette étape, n'utilisez pas de lubrifiant.

3. Processus de perçage

Percez le trou à vitesse et avance fixes, en arrêtant de temps en temps pour évacuer les copeaux. Utilisez du lubrifiant.

4. Retirer les restes

Les restes peuvent être retirés en utilisant un buril ou similaire

- Diseño especial para retirar machos rotos.
- Requiere una buena sujeción de pieza y cabezal rígido.
- No válido para extraer machos de laminación.
- Specifically designed for removing broken taps.
- It is recommended to use a proper fixing with an stable chuck.
- Not suitable for forming taps.
- Conception spéciale pour enlever les tarauds cassés.
- Nécessite un bon serrage de la pièce et une tête rigide.
- Non valide pour retirer les tarauds réfileurs.

D mm	d mm	L mm	l mm	Macho * Tap - Taraud		Nº Art. MD/HM	€
2,00	3,00	38	10	M3	1	58951	36,87
3,00	3,00	38	15	M4 - M5	1	58954	36,87
4,00	4,00	50	20	M6	1	59987	50,71
5,00	5,00	50	25	M8 - M10	1	59989	57,08
6,00	6,00	60	30	M12	1	66145	63,38
7,00	8,00	79	35	M14	1	66399	84,63
8,00	8,00	79	40	M16	1	66407	84,63
9,00	10,00	100	45	M18	1	66408	109,49
10,00	10,00	100	50	M20	1	66409	109,49

* El Ø de la broca deberá ser superior al Ø núcleo del macho.
The Ø of the drill bit must be greater than the Ø of the tap core.
Le Ø du foret doit être supérieur au Ø du noyau du taraud.



Set 5 Pcs

Cont.	Nº Art.	€
2-3-4-5-6 mm	83426	232,67



Ref. **3409**

EXTRACTOR TORNILLOS

Screw Extractor
Extracteur vis



Mod.	P/ Tornillo F/ Screw P/ Vis	P/ Tornillo F/ Screw P/Vis	D mm	a mm	Nº Art.	€
010	M3-M6	1/8-1/4	2,50	2,70	40639	3,08
020	M6-M8	1/4-5/16	3,00	3,80	40641	3,08
030	M8-M11	5/16-7/16	4,50	4,90	40642	3,21
040	M11-M14	7/16-9/16	6,00	7,00	40644	4,54
050	M15-M18	9/16-3/4	8,00	9,00	40645	7,12
060	M18-M24	3/4-1	11,00	12,00	40647	11,30



Set 5 Pcs

Set P/ Tornillo F/ Screw P/ Vis	P/ Tornillo F/ Screw P/ Vis	Nº Art.	€
M3-M18	1/8-3/4	75905	21,03

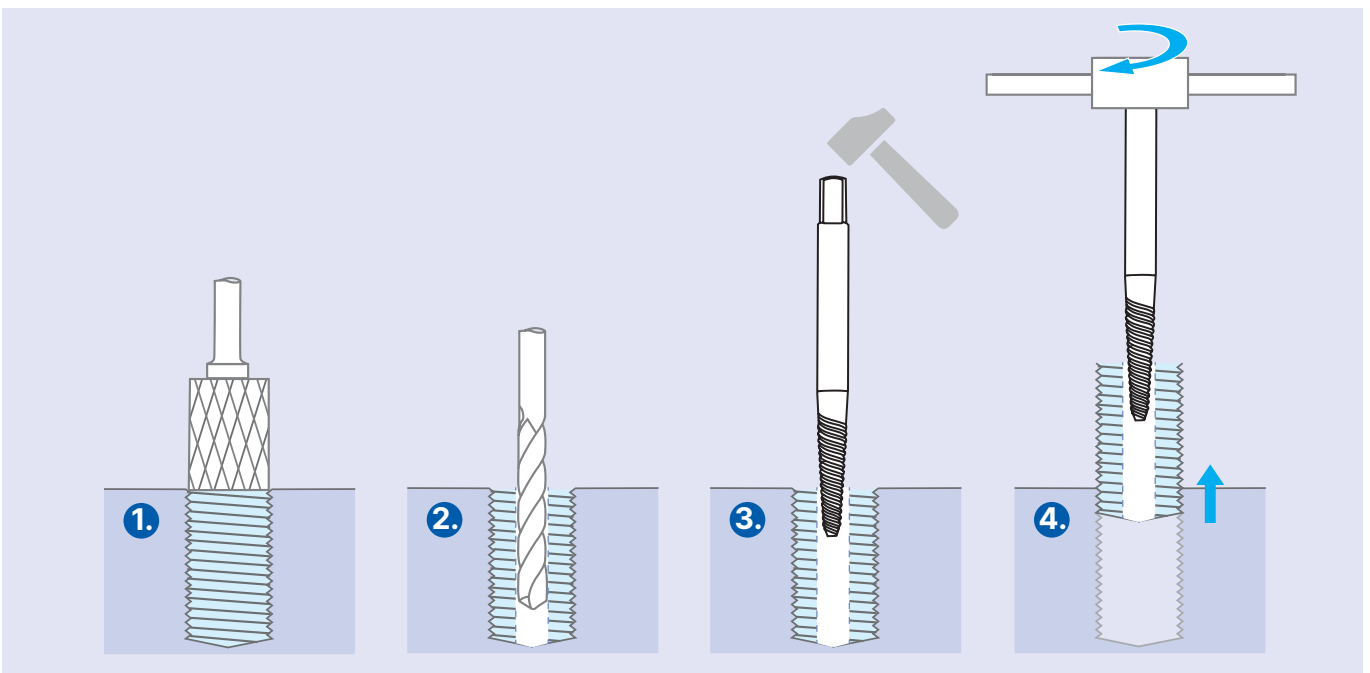

INSTRUCCIONES USO:

1. Alisar la superficie del tornillo con rotativa Ref. 9260.
2. Taladrar un agujero centrado con broca apropiada. Recomendamos Ref. 1016.
3. Introducir el extractor asegurándose de que quede fijo.
4. Girar el extractor hacia la izquierda hasta extraer el tornillo.

DIRECTIONS FOR USE:

1. Grind the Surface of the screw head with Rotary Burr Ref. 9260.
2. Drill a hole on the screw using a suitable drill bit. We recommend our Ref. 1016.
3. Introduce the extractor and make sure it gets fixed/locked.
4. Turn left the extractor until the screw gets out.

INSTRUCTIONS D'EMPLOI:

1. Lissez la surface de la vis avec une fraise lime rotative Réf. 9260.
2. Percez un trou centré avec un foret approprié. Nous recommandons notre Réf. 1016.
3. Insérez l'extracteur et assurez-vous qu'il est fixé.
4. Tournez à gauche l'extracteur jusqu'à retirer la vis.

Línea 33 cm - Ref. 3409

19
cm



Mod.	10	20	30	40	50	60
Pcs	5	5	5	5	5	4

Ref. 4995 - Nº Art. 72139: 150,35 €





ACEITES DE CORTE Y REFRIGERANTES

Cutting Oils & Water Soluble Fluids

Huiles de coupe et lubrifiants

ACEITES DE CORTE

Aceite de corte de uso general de alta gama, formulado a base de aceites vegetales y libre de cloruros. Para aplicaciones de corte en general (taladrado, roscado, fresado, torneado, etc.)

Cutting Oils

High-end general purpose cutting oil, formulated from vegetable oils and chloride-free. For general cutting applications (drilling, threading, milling, turning, etc.)

Huiles de coupe

Huile de coupe à usage général haut de gamme, formulée à base d'huiles végétales et sans chlorures. Pour des applications de coupe en général (perçage, taraudage, fraisage, tournage, etc.).

REFRIGERANTES - TALADRINA

Aceite emulsionable altamente concentrado libre de cloruros, aminos secundarios y / o nitritos

Water Soluble Fluids

Highly concentrated emulsifiable oil free of chlorides, secondary amines and/or nitrites

Lubrifiants

Huile émulsifiable hautement concentrée, exempte de chlorures, d'amines secondaires et/ou de nitrites



ACEITES DE CORTE

Cutting Oils - Huiles de coupe

UNI
Universal

New!

Viscosidad a 40°C Viscosity / Viscosité: 37 cSt	No Soluble
---	---------------

- * Disponible Ficha Técnica
- * Data Sheet available
- * Fiche technique disponible

APLICACIÓN:

Para aplicaciones de uso general y universal (UNI) en todos los metales ferrosos.

APPLICATION:

For general purpose and universal (UNI) applications on all ferrous metals.

APPLICATION:

Pour des applications à usage général et universel (UNI) sur tous les métaux ferreux.



Cont.	250 ml
Nº Art.	53898
€	9,11

Cont.	500 ml
Nº Art.	53901
€	12,31

Cont.	1L
Nº Art.	53903
€	28,16

Cont.	5L
Nº Art.	53904
€	98,41

Cont.	10L
Nº Art.	53906
€	180,56

Cont.	25L
Nº Art.	53907
€	354,70

INOX
Heavy Duty

New!

VISCOSIDAD EXTRA !
Extra Viscosity!
Viscosité supplémentaire !

Viscosidad a 40°C Viscosity / Viscosité: 173 cSt	No Soluble
--	---------------

- * Disponible Ficha Técnica
- * Data Sheet available
- * Fiche technique disponible

APLICACIÓN:

Para aplicaciones de mecanizado pesado (Heavy Duty) en todos los metales ferrosos y para un rendimiento mejorado en aceros inoxidables (INOX).

APPLICATION:

For heavy duty machining applications on all ferrous metals and for improved performance on stainless steels (STAINLESS).

APPLICATION:

Pour des applications d'usinage lourd (Heavy Duty) sur tous les métaux ferreux et pour améliorer les performances sur les aciers inoxydables (INOX).



Cont.	250 ml
Nº Art.	53928
€	13,97

Cont.	500 ml
Nº Art.	53934
€	24,88

Cont.	1L
Nº Art.	53936
€	43,71

Cont.	5L
Nº Art.	53937
€	156,90

Cont.	10L
Nº Art.	53940
€	299,14

Cont.	25L
Nº Art.	53942
€	648,16



ALU

New!

Non Ferrous

Viscosidad a 40°C
Viscosity / Viscosité:
4,20 cSt

No Soluble

- * Disponible Ficha Técnica
- * Data Sheet available
- * Fiche technique disponible

APLICACIÓN:

Especial para aplicaciones en todos los metales no ferrosos como aluminio (ALU), cobre, latón, bronce, zinc

APPLICATION:

Specially for applications on all non-ferrous metals such as aluminium (ALU), copper, brass, bronze, zinc, etc.

APPLICATION:

Spécialement indiqué pour les applications sur tous les métaux non ferreux, tels que l'aluminium (ALU), le cuivre, le laiton, le bronze, le zinc, etc.



Cont.	250 ml
Nº Art.	53943
€	12,60



Cont.	500 ml
Nº Art.	53946
€	20,56



Cont.	1L
Nº Art.	53948
€	34,42



Cont.	5L
Nº Art.	53949
€	127,38



Cont.	25L
Nº Art.	79042
€	580,19

New! DISPLAYS

9×250ml
UNI

Nº Art.	€
13929	77,89

Set Price!



UNI
Universal



UNI+INOX+ALU
3+3+3×250ml
MIXTO

Nº Art.	€
13930	101,69

Set Price!



UNI **INOX** **ALU**
Universal Heavy Duty Non Ferrous



6×400ml
AEROSOL

Nº Art.	€
13912	89,32

Set Price!



UNI
Universal



New! AEROSOL - Aerosol - Aérosol

2 Cánulas / 2 Nozzles / 2 Canules



Chorro líquido
Liquid jet
Jet liquide



Cont. 400ml
Nº Art. 53900
€ 15,67
Spray

Para aplicaciones de uso general en todos los metales ferrosos
For general purpose applications on all ferrous metals
Pour des applications à usage général sur tous les métaux ferreux



12 UNI

Nº Art.	€
53926	178,64

Box Price!

New! ESPUMA - Foam - Mousse



Fuerte adhesión sin goteos. Lavable con agua
Strong adherence without drips. Washable with water
Forte adhérence sans gouttes. Lavable à l'eau

Cont. 400ml
Nº Art. 48302
€ 20,41



12 UNI

Nº Art.	€
48299	232,67

Box Price!

MULTI

Multiusos

New!

Multiusos - Multi-purpose - Multifonction

APLICACIÓN:

Mecanizado de aceros duros, inoxidable, aleaciones de cobre y toda clase de metales

Fuertemente aditivado para lubricar y proteger contra la corrosión

APPLICATION:

Machining of hard steels, stainless steels, copper alloys and all kinds of metals

Highly additivated for lubrication and corrosion protection

APPLICATION:

Usinage d'aciers durs, inoxydables, alliages de cuivre et tous types de métaux

Fortement additivé pour la lubrification et la protection contre la corrosion



Cont. 400ml
Nº Art. 84040
€ 14,55



Pulveriza abiertamente con la cánula hacia abajo

Spray openly with the nozzle facing down

Vaporise ouvertement avec la canule vers le bas



Pulveriza con precisión con la cánula hacia arriba

Spray precisely with the nozzle facing up

Vaporise précisément avec la canule vers le haut



12 UNI

Nº Art.	€
84335	165,87

Box Price!



New! PASTA DE CORTE - Cutting Paste - Pâte de coupe

Pasta con propiedades lubricantes extremas. La pasta se asienta en las aristas de corte y se licua durante la operación de corte.

Ideal para todas las operaciones como roscado, taladrado y fresado de materiales difíciles de cortar como acero inoxidable, acero Cr-Ni, titanio, acero al manganeso, etc.

Paste with extreme lubricating properties. The paste settles on the cutting edges and liquefies during the cutting operation.

Ideal for all operations such as the threading, drilling and milling of difficult-to-cut materials such as stainless steel, Cr-Ni steel, titanium, manganese steel, etc.

Pâte aux propriétés lubrifiantes extrêmes. La pâte se dépose sur les bords de coupe et se liquéfie pendant l'opération de coupe.

Idéale pour toutes les opérations telles que le taraudage, le perçage et le fraisage de matériaux difficiles à couper comme l'acier inoxydable, l'acier Cr-Ni, le titane, l'acier au manganèse, etc.



Cont. 250ml

Nº Art. 53954

€ 17,20

Cont. 750ml

Nº Art. 53956

€ 28,64

Sumerja la herramienta de corte en la pasta para obtener resultados optimizados

Dip the cutting tool into the paste for optimised results

Trempez l'outil de coupe dans la pâte pour des résultats optimisés



New! CERA DE CORTE - Cutting Wax - Cire de coupe

Cera en barra de alta gama para refrigerante y lubricación de operaciones de corte en metales no ferrosos como aluminio, cobre, latón, etc. Libre de cloruros, sin humos o vapores nocivos.

Para todas las máquinas de hoja de sierra circular o sierra de cinta sin suministro de refrigerante. También apto para fresado, roscado, escariado, taladrado, torneado, etc.

High-end wax in a bar for the cooling and lubrication of cutting operations on non-ferrous metals such as aluminium, copper, brass, etc. Chloride free, no harmful fumes or vapours.

For all circular or band saw blade machines without coolant supply. Also suitable for milling, threading, reaming, drilling, turning, etc.

Cire en barre haut de gamme pour le refroidissement et la lubrification des opérations de coupe sur les métaux non ferreux tels que l'aluminium, le cuivre, le laiton, etc. Sans chlorures, sans fumées ni vapeurs nocives.

Pour toutes les machines à lame de scie circulaire ou à ruban sans alimentation en réfrigérant. Convient également pour le fraisage, taraudage, alésage, perçage, tournage, etc.



Cont. 300ml

Nº Art. 53957

€ 29,95



Para aplicar la cera, sostenga brevemente la barra de cera contra la sierra giratoria. Repita cada 10-20 ciclos de aserrado

To apply the wax, briefly hold the wax bar against the rotary saw. Repeat every 10-20 sawing cycles

Pour appliquer la cire, maintenez brièvement la barre de cire contre la scie rotative. Répétez tous les 10 à 20 cycles de sciage



REFRIGERANTES - TALADRINA

Water Soluble Fluids - Lubrificants

STD

New!

Standard

Emulsión semisintética, transparente a semitransparente. Muy alta estabilidad ante los microorganismos. Apto para operaciones de rectificado. Concentración del 4-7% en función de la aplicación.

Semi-synthetic emulsion, transparent to semi-transparent. Very high stability to micro-organisms. Suitable for grinding operations. Concentration 4-7% depending on the application.

Émulsion semi-synthétique, transparente à semi-transparente. Très grande stabilité face aux microorganismes. Convient pour les opérations de meulage. Concentration de 4-7 % selon l'application.

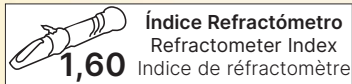

- * Disponible Ficha Técnica
- * Data Sheet available
- * Fiche technique disponible

STANDARD

Cont.	5L
Nº Art.	53958
€	94,75

TOP

New!

Top Line

Emulsión de color blanco lechoso. Para aplicaciones de alto rendimiento en aceros, materiales no ferrosos y aluminio. Concentración 6-10% en función de la aplicación.

Milky white emulsion. For high performance applications on steels, non-ferrous materials and aluminium. Concentration 6-10% depending on application.

Émulsion blanche laiteuse. Pour des applications de haute performance sur les aciers, les matériaux non ferreux et l'aluminium. Concentration de 6-10 % selon l'application.

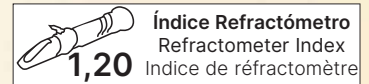

- * Disponible Ficha Técnica
- * Data Sheet available
- * Fiche technique disponible

TOP LINE

Cont.	5L
Nº Art.	53959
€	111,19



REPARADORES ROSCAS

Thread Repairs

Filets rapportés

Descripción

Desgaste, corrosión, excesiva torsión al ajustar el tornillo... son algunas de las causas que llevan a dañar una rosca sin posibilidad de reparación.

La gama de reparadores de roscas IZARCOIL permite reparar dichas roscas dañadas de manera rápida y económica. Unos reparadores de acero de gran calidad, para crear una rosca resistente a la temperatura y la corrosión.

Ventajas

- Instalación rápida y sencilla
- Resistente al desgaste y a la tensión
- Resistente a la corrosión y termoestable

Ejemplos de aplicaciones

- Refuerzo para roscar materiales con una reducida resistencia (p.e. aleaciones de aluminio y aleaciones de magnesio)
- Ingeniería mecánica
- Ingeniería de automoción y electricidad

Description

Wear, corrosion or excessive screw tightening torque... are some of the reasons that lead to threads getting damaged beyond repair.

IZARCOIL thread repair range enables worn and damaged threads to be repaired quickly and at low cost.

In high-quality steel for a good thread, resistant to temperature and corrosion.

Advantages

- Fast and easy to install
- Stress resistant and wear-free
- Corrosion resistant and thermostable

Examples of Applications

- Thread reinforcement for materials with low shearing strength (e.g. aluminium or magnesium alloys)
- Mechanical engineering
- Automotive and electrical engineering

Description

Usure et trop de pression dans la fixation de la vis son des raisons pour endommager un filetage sans possibilité de réparation.

La gamme de filets rapportés IZARCOIL vous permet de réparer les filets endommagés rapidement et d'une façon économique.

Filets rapportés en aciers haute qualité pour avoir un filetage résistant à la température et à l'usure.

Avantages

- Installation rapide et simple
- Résistant à l'usure et a la tension
- Résistant aux variations de température

Exemples d'applications

- Soutien pour fileter aciers avec faible resistances (alliage aluminium et magnesium).
- Ingénierie mécanique
- Ingénierie auto et électricité

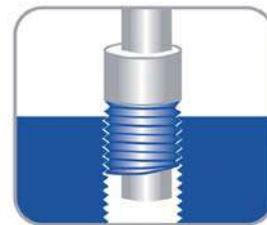

Uso

- 1- Taladrar la rosca dañada con una broca
- 2- Roscar con un macho IZARCOIL
- 3- Biselar el diámetro exterior a 90° y retirar la rebaba
- 4- Insertar el reparador de roscas con la ayuda del vástago
- 5- En caso de agujeros pasantes, usar un rompedor para la muesca

Use

- 1- Drill the thread with a Drill Bit
- 2- Thread with an IZARCOIL tap
- 3- Bevel the external diameter at 90° and remove the burr
- 4- Insert the thread repair using the fitting tool
- 5- In case of through holes, use a pin-breaker for the notch

Emploi

- 1- Percer le filet endommagé avec un foret
- 2- Tarauder avec un taraud IZARCOIL
- 3- Chanfreiner le diamètre extérieur à 90° et retirer les copeaux
- 4- Insérer le réparateur de filets avec l'aide du guide
- 5- Pour trous débouchants, employer un brise-copeaux



Ref. **3300**

INSERTO REPARACIÓN ROSCAS

Thread Repair Insert
Filet rapportés



INOX
304

M/MF

Aceros
Steels
Aciers

Aleaciones Alum.
Alloys / Alliages
Aleaciones Mg Alloys / Alliages

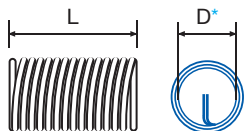

*D = M (aprox.)



M	P	L = 1xD			L = 1,5xD			L = 2xD			L = 2,5xD			L = 3xD		
		Icon	Nº Art.	€ 1 ud.	Icon	Nº Art.	€ 1 ud.	Icon	Nº Art.	€ 1 ud.	Icon	Nº Art.	€ 1 ud.	Icon	Nº Art.	€ 1 ud.
M3	0,50	25	56287	0,22	25	56288	0,22	25	56289	0,24	25	56291	0,28	25	56292	0,38
M4	0,70	25	56293	0,22	25	56294	0,22	25	56297	0,24	25	56299	0,28	25	56300	0,35
M5	0,80	25	56302	0,24	25	56303	0,22	25	56304	0,28	25	56306	0,34	25	56309	0,42
M6+ *	1,00	25	56310	0,24	25	56311	0,22	25	56312	0,28	25	56313	0,34	25	56315	0,50
New! M6- *	1,00	25	14857	0,24	25	14859	0,22	25	14863	0,28	25	14865	0,34	25	14866	0,50
M7	1,00	25	56316	0,25	25	56318	0,31	25	56319	0,34	25	56320	0,39	25	56321	0,60
M8	1,00	25	56322	0,28	25	56324	0,31	25	56325	0,38	25	56326	0,46	25	56327	0,63
M8	1,25	25	56332	0,25	25	56333	0,28	25	56334	0,36	25	56336	0,44	25	56337	0,60
M9	1,25	25	56339	0,38	25	56340	0,44	25	56341	0,53	25	56342	0,55	25	56343	0,72
MF10	1,00	25	56344	0,31	25	56345	0,36	25	56346	0,41	25	56347	0,53	25	56348	0,70
MF10	1,25	25	56349	0,31	25	56351	0,36	25	56352	0,41	25	56353	0,53	25	56354	0,70
M10	1,50	25	56355	0,31	25	56357	0,36	25	56360	0,41	25	56361	0,53	10	56362	0,70
M11	1,50	25	56363	0,46	25	56364	0,63	10	56365	0,67	10	56366	0,84	10	56367	1,03
MF12	1,00	25	56369	0,39	25	56371	0,58	10	56372	0,66	10	56373	0,77	10	56374	1,03
MF12	1,25	25	56375	0,39	25	56377	0,58	10	56378	0,66	10	56379	0,77	10	56381	1,03
MF12	1,50	25	56384	0,39	25	56385	0,58	10	56387	0,66	10	56388	0,77	10	56389	1,03
M12	1,75	25	56390	0,39	25	56391	0,58	10	56392	0,66	10	56393	0,77	10	56394	1,03
MF14	1,00	10	56395	0,88	10	56396	0,90	10	56397	1,03	10	56399	1,25	10	56400	1,77
MF14	1,25	10	56401	0,73	10	56402	0,82	10	56403	0,88	10	56404	1,03	10	56405	1,37
MF14	1,50	10	56406	0,73	10	56407	0,82	10	56408	0,88	10	56409	1,03	10	56410	1,37
M14	2,00	10	58844	0,73	10	58845	0,82	10	58846	0,88	10	58847	1,04	10	58848	1,37
MF16	1,50	10	56411	0,97	10	56412	1,02	10	56413	1,27	10	56414	1,38	10	56416	1,77
M16	2,00	10	56417	0,97	10	56419	1,02	10	56420	1,27	10	56422	1,38	10	56423	1,77
MF18	2,00	10	56425	1,41	10	56427	1,65	10	56430	2,22	10	56431	2,53	10	56433	3,27
M18	2,50	10	56434	1,41	10	56436	1,65	10	56439	2,22	10	56440	2,53	10	56442	3,27
M20	2,50	10	67788	1,78	10	67790	2,22	10	67792	2,83	10	67794	3,22	10	70628	3,77
M22	2,50	10	56445	1,79	10	56446	2,22	10	56448	2,84	10	56451	3,24	10	56452	4,28
MF24	2,00	10	56454	2,22	10	56457	2,36	10	56458	2,99	10	56460	3,90	10	56463	4,56
M24	3,00	10	56464	2,22	10	56466	2,36	10	56467	2,99	10	56473	3,90	5	56476	4,56

* M6+ → ø7,6 - ø7,7

* M6- → ø7,3 - ø7,4



Ref. **3305**

MACHO PARA INSERTO REPARACIÓN ROSCAS

Thread Repair Insert Tap
Taraud filet rapportés



IZARCOIL

HSS

M/MF

Aceros
Steels
Aciers

Aleaciones Alum.
Alloys / Alliages
Aleaciones Mg Alloys / Alliages



M	P	D mm	d mm	L mm	l mm	a mm	Z	Nº Art.	€
M3	0,50	3,65	4,00	53	13	3,15	3	56615	8,54
M4	0,70	4,91	5,00	58	16	4,00	3	56617	9,24
M5	0,80	6,04	6,30	66	19	5,00	3	56620	9,38
M6	1,00	7,30	8,00	72	22	6,30	3	56622	9,38
M7	1,00	8,30	9,00	72	22	7,10	3	56623	13,10
M8	1,00	9,30	10,00	80	24	8,00	3	56628	13,10
M8	1,25	9,62	10,00	80	24	8,00	3	56626	12,23
M9	1,25	10,60	8,00	85	25	6,30	3	56629	16,04
MF10	1,00	11,30	8,00	85	25	6,30	3	56638	16,04
MF10	1,25	11,62	8,00	85	25	6,30	3	56634	16,04
M10	1,50	11,95	9,00	89	29	7,10	3	56632	16,04
M11	1,50	12,95	9,00	89	29	7,10	3	56640	18,15
MF12	1,00	13,30	11,20	95	30	9,00	3	56646	22,17
MF12	1,25	13,62	11,20	95	30	9,00	3	56648	22,17
MF12	1,50	13,95	11,20	95	30	9,00	3	56647	22,17
M12	1,75	14,27	11,20	95	30	9,00	3	56644	17,21
MF14	1,00	15,30	12,50	102	32	10,00	3	56650	25,24
MF14	1,25	15,62	12,50	102	32	10,00	3	56652	25,24
MF14	1,50	15,95	12,50	102	32	10,00	3	56651	25,24
M14	2,00	16,70	12,50	102	32	10,00	4	58849	25,24
MF16	1,50	18,00	14,00	104	29	11,20	4	56654	30,20
M16	2,00	18,60	14,00	112	37	11,20	4	56653	30,20
MF18	2,00	20,60	14,00	104	29	11,20	4	56657	38,23
M18	2,50	21,30	16,00	118	38	12,50	4	56656	38,23
M20	2,50	23,32	16,00	118	38	12,50	4	72852	43,29
M22	2,50	25,30	18,00	130	45	14,00	4	56658	48,36
MF24	2,00	26,60	20,00	127	37	16,00	4	56660	61,13
M24	3,00	27,90	20,00	138	48	16,00	4	56659	61,13

D Broca Drill Bit / Punta mm
3,20
4,20
5,20
6,30
7,30
8,30
8,30
9,40
10,30
10,30
10,40
11,50
12,30
12,30
12,50
12,50
14,30
14,30
14,50
14,50
16,50
16,50
18,50
18,75
20,75
23,00
24,50
25,00



Ref. **3303**

INSERTADOR

Fitting Tool
Appareil de Pose



M	L mm	D mm		N° Art.	€
M3	132	2,20	1	70226	10,93
M4	132	3,00	1	66774	10,93
M5	132	4,00	1	66775	10,93
M6	132	4,90	1	66776	10,93
M8	132	6,50	1	66777	12,39
M10	132	7,00	1	66778	12,39
M12	132	9,50	1	66779	15,40
M14	132	11,00	1	66780	18,14
M16	132	12,75	1	79464	19,39
M18	132	14,90	1	79466	19,39
M20	132	15,95	1	79467	19,39
M22	132	17,95	1	83203	21,81
M24	132	20,00	1	79468	24,23



Ref. **3307**

ROMPE ARRASTRES

Pin-Breaker
Rupteur



M	L mm	D mm		N° Art.	€
M3	100	2,20	1	70238	4,69
M4	100	3,00	1	66781	4,69
M5	100	4,00	1	66782	4,69
M6	100	4,90	1	66783	4,69
M8	100	6,50	1	66784	5,13
M10	100	7,00	1	66785	5,13
M12	100	9,50	1	66786	6,16
M14	100	11,00	1	66787	8,20
M16	100	12,75	1	79470	8,77
M18	100	14,90	1	79476	8,77
M20	100	15,95	1	79477	8,77
M22	100	17,95	1	83205	9,87
M24	100	20,00	1	79478	10,95



Ref. **3310**

SET REPARACIÓN ROSCAS

Thread Repair Set
Set filet rapportés



M

Aceros
Steels
Aciers

Aleaciones Alum. Alloys / Alliages
Aleaciones Mg Alloys / Alliages



Set 95 Pcs

Cont. M5-M12					Nº Art.	€
Insertos Inserts Rapportes		M5 0,80	5 pcs 1xD + 5 pcs 1,5xD + 5 pcs 2,5XD		56481	275,21
		M6 1,00	5 pcs 1xD + 5 pcs 1,5xD + 5 pcs 2,5XD			
		M8 1,25	5 pcs 1xD + 5 pcs 1,5xD + 5 pcs 2,5XD			
		M10 1,50	5 pcs 1xD + 5 pcs 1,5xD + 5 pcs 2,5XD			
		M12 1,75	5 pcs 1xD + 5 pcs 1,5xD + 5 pcs 2,5XD			
Brocas Drill Bits Forets (D mm)		5,20 - 6,30 - 8,30 - 10,40 - 12,50				
Machos Taps Tarauds (D mm)		6,04 - 7,30 - 9,62 - 11,95 - 14,27				
Insertadores Fitting Tools Appareils de pose (D mm)		4,00 - 4,50 - 6,25 - 7,20 - 9,50				
Rompe arrastres Pin-Breakers Rupteurs (D mm)		4,00 - 4,50 - 6,25 - 7,20 - 9,50				

Ref. **3311**

SET REPARACIÓN ROSCAS BUJÍAS

Spark Plug Thread Repair Set
Set filet rapportés bougies



M/MF



Aceros
Steels
Aciers

Aleaciones Alum. Alloys / Alliages
Aleaciones Mg Alloys / Alliages



Set 94 Pcs

Cont. M6-M14					Nº Art.	€
Insertos Inserts Rapportes		M6 1,00	5 pcs 1xD + 5 pcs 1,5xD + 5 pcs 2,5XD		56482	317,14
		M8 1,25	5 pcs 1xD + 5 pcs 1,5xD + 5 pcs 2,5XD			
		M10 1,50	5 pcs 1xD + 5 pcs 1,5xD + 5 pcs 2,5XD			
		M12 1,75	5 pcs 1xD + 5 pcs 1,5xD + 5 pcs 2,5XD			
		MF14 1,25	5 pcs 1xD + 5 pcs 1,5xD + 5 pcs 2,5XD			
Brocas Drill Bits Forets (D mm)		6,30 - 8,30 - 10,40 - 12,50				
Machos Taps Tarauds (D mm)		7,30 - 9,62 - 11,95 - 14,27 - 15,60				
Insertadores Fitting Tools Appareils de pose (D mm)		4,50 - 6,25 - 7,20 - 9,50 - 11,00				
Rompe arrastres Pin-Breakers Rupteurs (D mm)		4,50 - 6,25 - 7,20 - 9,50 - 11,00				



Ref. **3312**

SET REPARACIÓN ROSCAS COMPLETO

Complete Thread Repair Set
Set filet rapportés complet



M/MF

**Aceros
Steels
Aciers**

**Aleaciones Alum. Alloys / Alliages
Aleaciones Mg Alloys / Alliages**



Set 19 Pcs

M	P	Insertos Inserts Rapportés	INOX 304	Brocas Drill Bits Forets (D mm)	HSS	Machos Taps Tarauds (D mm)	HSS	Insertadores Fitting Tools Appareils de pose (D mm)	Rompe arrastres Pin-Breakers Rupteurs (D mm)	Nº Art.	€
M3	0,50	5pcs 1xD + 5 pcs 1,5xD + 5 pcs 2,5xD		3,20		3,65		2,20	2,20	60330	39,06
M4	0,70	5 pcs 1xD + 5 pcs 1,5xD + 5 pcs 2,5xD		4,20		4,91		3,00	3,00	56484	39,06
M5	0,80	5 pcs 1xD + 5 pcs 1,5xD + 5 pcs 2,5xD		5,20		6,04		4,00	4,00	56487	38,86
M6	1,00	5 pcs 1xD + 5 pcs 1,5xD + 5 pcs 2,5xD		6,30		7,30		4,90	4,90	56488	41,84
M7	1,00	5 pcs 1xD + 5 pcs 1,5xD + 5 pcs 2,5xD		7,30		8,30		4,90	4,90	67804	50,92
MF8	1,00	5 pcs 1xD + 5 pcs 1,5xD + 5 pcs 2,5xD		8,30		9,30		6,50	6,50	56497	50,92
M8	1,25	5 pcs 1xD + 5 pcs 1,5xD + 5 pcs 2,5xD		8,30		9,62		6,50	6,50	56490	50,92
New! MF10	1,00	5 pcs 1xD + 5 pcs 1,5xD + 5 pcs 2,5xD		10,30		11,30		7,00	7,00	12675	56,97
MF10	1,25	5 pcs 1xD + 5 pcs 1,5xD + 5 pcs 2,5xD		10,30		11,62		7,00	7,00	56500	56,97
M10	1,50	5 pcs 1xD + 5 pcs 1,5xD + 5 pcs 2,5xD		10,40		11,95		7,00	7,00	56493	56,97
MF12	1,00	5 pcs 1xD + 5 pcs 1,5xD + 5 pcs 2,5xD		12,30		13,30		9,50	9,50	57967	65,34
MF12	1,50	5 pcs 1xD + 5 pcs 1,5xD + 5 pcs 2,5xD		12,50		13,95		9,50	9,50	57964	65,34
M12	1,75	5 pcs 1xD + 5 pcs 1,5xD + 5 pcs 2,5xD		12,50		14,27		9,50	9,50	56496	65,34
MF14	1,25	5 pcs 1xD + 5 pcs 1,5xD + 5 pcs 2,5xD		*14,30		15,62		11,00	11,00	57973	66,38
M14	2,00	5 pcs 1xD + 5 pcs 1,5xD + 5 pcs 2,5xD		*14,50		16,60		11,00	11,00	57970	75,11
New! MF16	1,50	5 pcs 1xD + 5 pcs 1,5xD + 5 pcs 2,5xD		*16,50		18,00		12,75	12,75	23220	86,45
New! M16	2,00	5 pcs 1xD + 5 pcs 1,5xD + 5 pcs 2,5xD		*16,50		18,60		12,75	12,75	23221	86,45

* **Diámetro de broca correspondiente. Broca no incluida**
Corresponding drill bit diameter. Drill bit not included
Diamètre de foret correspondant. Foret non inclus



FRESAS ROTATIVAS

Rotary Burrs

Fraises limes rotatives

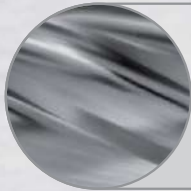

Dentado
Teeth
Denture **1**

MATERIALES NO FERROSOS
Non-Ferrous Materials
Matériaux non ferreux

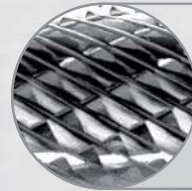

Dentado
Teeth
Denture **6**

MATERIALES DUROS
Hard Materials
Matériaux Durs



Dentado
Teeth
Denture **3**

USO GENERAL
General Purpose
Utilisation Générale



Dentado
Teeth
Denture **M**

INOXIDABLES
Stainless Steels
Aciers Inox

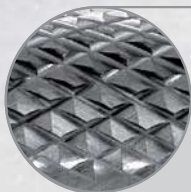

Dentado
Teeth
Denture **4**

VIRUTA CORTA
Short Chipping
Copeaux Courts



Dentado
Teeth
Denture **S**

TITANIO, INCONEL...
Titanium, Inconel...
Titane, Inconel...



Ref. **9260**

FRESA ROTATIVA MD TIPO B

B Type HM Rotary Burr
Fraise lime rotative carbure type B



MD HM Carbure	MD/HM + ALTIM	Tipo B Type	Norma ZYA-S Norm
-----------------------------------	----------------------------	---------------------------------	-------------------------------

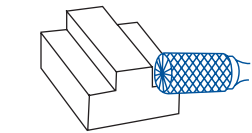
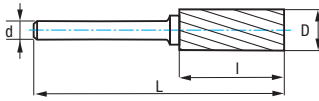

1
MATERIALES NO FERROSOS
Non-Ferrous Materials
Matériaux non ferreux



3
USO GENERAL
General Purpose
Utilisation Générale



4
VIRUTA CORTA
Short Chipping
Copeaux Courts

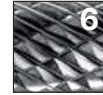

6
MATERIALES DUROS
Hard Materials
Matériaux Durs

D mm	d mm	L mm	l mm	Dentado Teeth / Denture 1		Dentado Teeth / Denture 1 ALTIM		Dentado Teeth / Denture 3		Dentado Teeth / Denture 4		Dentado Teeth / Denture 6		Dentado Teeth / Denture 6 ALTIM	
				Nº Art.	€	Nº Art.	€	Nº Art.	€	Nº Art.	€	Nº Art.	€	Nº Art.	€
3,00	3,00	38,00	14,00	55677	11,71			44072	10,35	44079	11,71	44086	11,33	66485	18,41
6,00	6,00	50,00	18,00	55680	25,06			44074	22,06	44081	25,06	44141	24,30	66486	32,00
6,30	3,00	45,00	12,70	55679	20,37			44073	17,46	44080	20,37	44122	19,21		
8,00	6,00	64,00	19,00	55681	31,61			44075	26,34	44082	31,61	44142	28,96	66487	37,19
9,60	6,00	64,00	19,00	44070	35,85	55864	43,38	44076	29,91	44083	35,85	44143	32,88	43567	39,80
12,70	6,00	70,00	25,00	44071	48,34	55866	78,58	44077	41,97	44084	50,40	44144	46,21	66488	72,09
12,70	8,00	70,00	25,00	55691	48,36			55689	40,33			55690	44,37		
16,00	6,00	70,00	25,00	55682	65,77			44078	54,82	44085	65,77	44145	60,28		
16,00	8,00	70,00	25,00	55695	60,98			55692	50,84			55693	55,93		
19,00	6,00	70,00	25,00	55685	90,68			55683	75,63			55684	83,19		
25,00	6,00	70,00	25,00	55688	126,79			55686	105,74			55687	116,32		

Ref. **9240**

FRESA ROTATIVA MD TIPO B LARGA

Long B Type HM Rotary Burr
Fraise lime rotative carbure type B longue



MD HM Carbure	Tipo B Type		Norma ZYA-S Norm
-----------------------------------	---------------------------------	--	-------------------------------

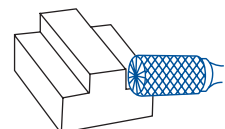
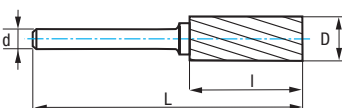

3
USO GENERAL
General Purpose
Utilisation Générale



6
MATERIALES DUROS
Hard Materials
Matériaux Durs

D mm	d mm	L mm	l mm	Dentado Teeth / Denture 3		Dentado Teeth / Denture 6	
				Nº Art.	€	Nº Art.	€
6,00	6,00	150,00	18,00	55832	75,23	55833	82,76
9,60	6,00	172,00	19,00	55834	50,43	55835	55,50
12,70	6,00	178,00	25,00	55836	71,39	55837	78,54



Ref. **9250**

FRESA ROTATIVA MD TIPO A

A Type HM Rotary Burr
Fraise lime rotative carbure type A



MD HM Carbure	MD/HM + ALTIN	Tipo A Type	Norma ZYA Norm
------------------------------	---------------------	----------------------------	-------------------------------

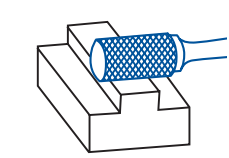
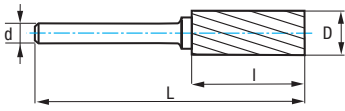

1
MATERIALES NO FERROSOS
Non-Ferrous Materials
Matériaux non ferreux



3
USO GENERAL
General Purpose
Utilisation Générale



4
VIRUTA CORTA
Short Chipping
Copeaux Courts



6
MATERIALES DUROS
Hard Materials
Matériaux Durs

D mm	d mm	L mm	l mm	Dentado Teeth / Denture 1		Dentado Teeth / Denture 1 ALTIN		Dentado Teeth / Denture 3		Dentado Teeth / Denture 4		Dentado Teeth / Denture 6		Dentado Teeth / Denture 6 ALTIN	
				N° Art.	€	N° Art.	€	N° Art.	€	N° Art.	€	N° Art.	€	N° Art.	€
3,00	3,00	38,00	14,00	55644	10,69			44149	9,26	44156	10,69	44245	10,18	66489	16,69
6,00	6,00	50,00	18,00	55648	22,76			44151	19,94	44158	22,76	44417	21,91	66490	28,79
6,30	3,00	45,00	12,70	55645	18,51			44150	15,66	44157	18,51	44301	17,23		
8,00	6,00	64,00	19,00	55651	29,04			44152	24,21	44159	29,04	44418	26,60	66491	33,85
9,60	6,00	64,00	19,00	44147	32,43	55861	49,30	44153	27,05	44160	32,43	44419	29,77	63933	45,24
12,70	6,00	70,00	25,00	44148	43,95	55863	71,45	44154	38,44	44161	46,11	44421	42,27	66492	65,55
12,70	8,00	70,00	25,00	55671	46,07			55669	38,44			55670	42,27		
16,00	6,00	70,00	25,00	55653	59,79			44155	49,82	44173	59,79	44422	54,82		
16,00	8,00	70,00	25,00	55675	55,42			55672	46,23			55673	50,84		
19,00	6,00	70,00	25,00	55664	82,44			55655	68,75			55657	75,63		
25,00	6,00	70,00	25,00	55668	115,27			55666	96,13			55667	105,75		

Ref. **9230**

FRESA ROTATIVA MD TIPO A LARGA

Long A Type HM Rotary Burr
Fraise Lime Rotative Carbure type A longue



MD HM Carbure	Tipo A Type		Norma ZYA Norm
------------------------------	----------------------------	--	-------------------------------



6
MATERIALES DUROS
Hard Materials
Matériaux Durs

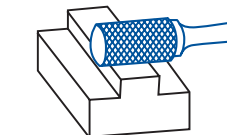
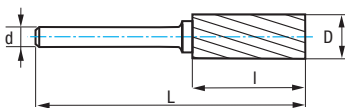

D mm	d mm	L mm	l mm	Dentado Teeth / Denture 6	
				N° Art.	€
6,00	6,00	150,00	18,00	55829	75,23
9,60	6,00	172,00	19,00	55830	50,43
12,70	6,00	178,00	25,00	55831	71,39



Ref. **9251**

FRESA ROTATIVA MD TIPO C RADIAL

Radial C Type HM Rotary Burr

Fraise lime rotative carbure type C hemisphérique



MD HM Carbure	MD/HM + ALTIM	Tipo C Type	Norma WRC Norm
----------------------------	---------------------	--------------------------	-----------------------------

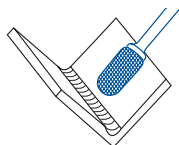
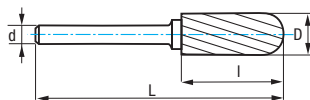

1
MATERIALES NO FERROSOS
Non-Ferrous Materials
Matériaux non ferreux



3
USO GENERAL
General Purpose
Utilisation Générale



4
VIRUTA CORTA
Short Chipping
Copeaux Courts



6
MATERIALES DUROS
Hard Materials
Matériaux Durs



S
TITANIO, INCONEL...
Titanium, Inconel...
Titane, Inconel...

D mm	d mm	L mm	I mm	Dentado Teeth / Denture 1		Dentado Teeth / Denture 1 ALTIM		Dentado Teeth / Denture 3		Dentado Teeth / Denture 4		Dentado Teeth / Denture 6		Dentado Teeth / Denture 6 ALTIM		Dentado Teeth / Denture S ALTIM	
				N° Art.	€	N° Art.	€	N° Art.	€	N° Art.	€	N° Art.	€	N° Art.	€	N° Art.	€
3,00	3,00	38,00	14,00	55696	13,69			44425	11,39	44431	13,69	44437	12,52	66493	16,69	83022	16,69
6,00	6,00	50,00	18,00	55698	25,65			44426	21,34	44432	25,65	44438	23,49	66494	29,50		
8,00	6,00	64,00	18,00	55699	31,61			44427	26,34	44433	31,61	44439	28,96	66495	36,82		
9,60	6,00	64,00	19,00	44423	36,72	55867	54,89	44428	30,59	44434	36,72	44440	33,65	66496	50,36		
12,70	6,00	70,00	25,00	44424	51,23	55868	80,13	44429	42,71	44435	51,23	44441	46,97	66497	73,51		
12,70	8,00	70,00	25,00	55708	49,31			55706	41,13			55707	45,25				
16,00	6,00	70,00	25,00	12138	66,61			44430	55,52	44436	66,61	44442	61,08				
16,00	8,00	70,00	25,00	55711	62,06			55709	51,75			55710	56,93				
19,00	6,00	70,00	25,00	55702	89,08			55700	74,29			55701	81,73				
25,00	6,00	70,00	25,00					55704	100,95			55705	111,02				

New!



M
INOXIDABLES
Stainless Steels
Aciers Inox

D mm	d mm	L mm	I mm	Dentado Teeth / Denture M	
				N° Art.	€
9,60	6,00	64,00	19,00	20076	33,65
12,70	6,00	70,00	25,00	20080	46,97

Ref. **9231**

FRESA ROTATIVA MD TIPO C RADIAL LARGA

Long Radial C Type HM Rotary Burr

Fraise lime rotative carbure type C hemisphérique longue



MD HM Carbure	Tipo C Type	Norma WRC Norm
----------------------------	--------------------------	-----------------------------

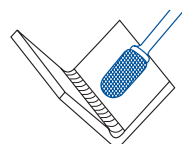
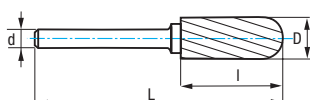

6
MATERIALES DUROS
Hard Materials
Matériaux Durs

D mm	d mm	L mm	I mm	Dentado Teeth / Denture 6	
				N° Art.	€
6,00	6,00	150,00	18,00	55838	76,93
9,60	6,00	172,00	19,00	55839	47,34
12,70	6,00	178,00	25,00	55840	67,16



Ref. **9252**

FRESA ROTATIVA MD TIPO N CONO INVERTIDO

Inverted Cone N Type HM Rotary Burr

Fraise lime rotative carbure type N sans coupe en bout



MD HM Carbure	Tipo N Type	Norma WKN Norm
-----------------------------------	--------------------------	-----------------------------

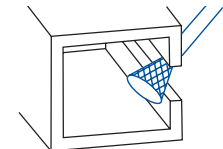
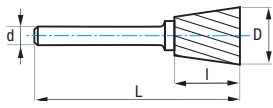

USO GENERAL
General Purpose
Utilisation Générale



VIRUTA CORTA
Short Chipping
Copeaux Courts



MATERIALES DUROS
Hard Materials
Matériaux Durs

D mm	d mm	L mm	l mm	Ang.	Dentado Teeth / Denture 3		Dentado Teeth / Denture 4		Dentado Teeth / Denture 6	
					Nº Art.	€	Nº Art.	€	Nº Art.	€
3,00	3,00	38,00	4,00	10°	44443	11,39	44450	13,69	44455	12,52
6,00	6,00	50,00	8,00	10°	44447	19,94	44452	23,92	44458	21,92
6,30	3,00	39,00	6,00	12°	44445	17,81	44451	21,36	44457	19,60
12,70	6,00	57,00	12,00	28°	44448	31,43	44453	37,71	44460	34,56
12,70	8,00	58,00	12,70	28°	55825	40,89			55826	44,99
16,00	6,00	64,00	19,00	18°	44449	52,53	44454	62,96	44461	57,76
16,00	8,00	64,00	19,00	18°	55827	52,53			55828	57,76
19,00	6,00	61,00	16,00	30°	55823	59,01			55824	64,91



Ref. **9254**

FRESA ROTATIVA MD TIPO G OJIVA

Tree G Type HM Rotary Burr

Fraise lime rotative carbure type G ogive



MD HM Carbure	MD/HM + ALTiN	Tipo G Type	Norma SPG Norm
-----------------------------------	---------------------	--------------------------	-----------------------------

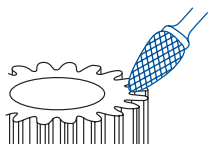
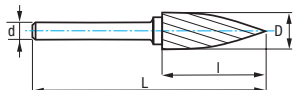

MAT. NO FERROSOS
Non-Ferrous Mat.
Mat. non ferreux



USO GENERAL
General Purpose
Utilisation Générale



VIRUTA CORTA
Short Chipping
Copeaux Courts



MATERIALES DUROS
Hard Materials
Matériaux Durs



New!

INOXIDABLES
Stainless Steels
Aciers Inox

D mm	d mm	L mm	l mm	Dentado Teeth / Denture 1		Dentado Teeth / Denture 3		Dentado Teeth / Denture 4		Dentado Teeth / Denture 6		Dentado Teeth / Denture 6 ALTiN		Dentado Teeth / Denture M	
				Nº Art.	€	Nº Art.	€	Nº Art.	€	Nº Art.	€	Nº Art.	€	Nº Art.	€
3,00	3,00	38,00	14,00	55783	13,69	44466	11,39	44472	13,69	44487	12,52	66505	16,69		
6,00	6,00	50,00	18,00	55784	25,65	44467	21,34	44473	25,65	44488	23,49	66506	29,21		
8,00	6,00	64,00	19,00	55785	29,04	44468	24,21	44474	29,04	44494	26,56				
9,60	6,00	64,00	19,00	44463	34,17	44469	28,49	44475	34,17	44500	31,31	55882	42,05	20087	31,31
12,70	6,00	70,00	25,00	44464	42,71	44470	35,59	44476	42,71	44512	39,15	27566	53,11	20088	39,15
12,70	8,00	70,00	25,00	55787	44,52	17105	37,12			55786	40,86				
16,00	6,00	70,00	25,00					44482	59,79						
16,00	6,00	75,00	30,00	44465	59,79	44471	49,82			44518	54,82				
16,00	8,00	70,00	25,00	55790	61,92	55788	51,65			55789	56,81				



Ref. **9255**

FRESA ROTATIVA MD TIPO M CÓNICA

Cone M Type HM Rotary Burr

Fraise lime rotative carbure type M conique



MD
HM
Carbure

Tipo
M
Type

Norma
SKM
Norm

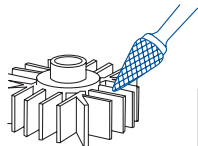
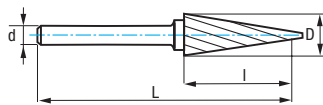

1
MAT. NO FERROSOS
Non-Ferrous Mat.
Mat. non ferreux



3
USO GENERAL
General Purpose
Utilisation Générale



4
VIRUTA CORTA
Short Chipping
Copeaux Courts



6
MATERIALES DUROS
Hard Materials
Matériaux Durs

D mm	d mm	L mm	l mm	Ang.	Dentado Teeth / Denture 1		Dentado Teeth / Denture 3		Dentado Teeth / Denture 4		Dentado Teeth / Denture 6	
					N° Art.	€	N° Art.	€	N° Art.	€	N° Art.	€
6,00	6,00	50,00	20,00	14°	55817	23,66	44530	19,70	44598	23,66	44616	21,67
6,30	3,00	49,00	12,70	22°	55816	19,70	44524	16,44	44595	19,70	44613	18,07
8,00	6,00	64,00	18,00	22°			44583	21,03	44601	25,24	44617	23,14
9,60	6,00	64,00	16,00	28°	55818	28,39	44586	23,66	44604	28,39	44619	26,03
12,70	6,00	71,00	22,00	28°	25335	37,86	44589	31,52	44607	37,86	44620	34,69
12,70	8,00	71,00	22,00	28°			55819	41,07			55820	45,18
16,00	6,00	71,00	25,00	31°			44592	42,71	44610	51,24	44622	46,97
16,00	8,00	71,00	25,00	31°			55821	54,81			55822	60,29

Ref. **9256**

FRESA ROTATIVA MD TIPO K CÓNICA 90°

90° Cone K Type HM Rotary Burr

Fraise lime rotative carbure type K conique 90°



MD
HM
Carbure

Tipo
K
Type

Norma
KSK
Norm

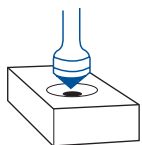
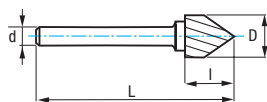

3
USO GENERAL
General Purpose
Utilisation Générale



4
VIRUTA CORTA
Short Chipping
Copeaux Courts



6
MATERIALES DUROS
Hard Materials
Matériaux Durs

D mm	d mm	L mm	l mm	Dentado Teeth / Denture 3		Dentado Teeth / Denture 4		Dentado Teeth / Denture 6	
				N° Art.	€	N° Art.	€	N° Art.	€
6,00	6,00	50,00	3,00	44625	17,09	44628	20,49	44631	18,80
12,70	6,00	55,00	6,30	44626	28,49	44629	34,14	44632	31,31
12,70	8,00	55,00	6,30	55802	28,42			55803	31,27
16,00	6,00	57,00	8,00	55796	37,87			55797	41,65
16,00	8,00	57,00	8,00	55804	37,87			55805	41,65
19,00	6,00	59,00	9,50	55798	49,72			55799	54,70
25,00	6,00	61,00	12,70	55800	79,77			55801	87,75



Ref. **9257**

FRESA ROTATIVA MD TIPO E GOTA

Oval E Type HM Rotary Burr
Fraise lime rotative carbure type E ovale



MD
HM
Carbure

Tipo
E
Type

Norma
TRE
Norm



New!

INOXIDABLES
Stainless Steels
Aciers Inox

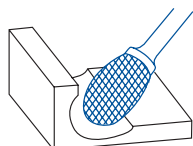
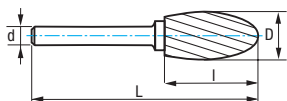

1
MAT. NO FERROSOS
Non-Ferrous Mat.
Mat. non ferreux



3
USO GENERAL
General Purpose
Utilisation Générale



4
VIRUTA CORTA
Short Chipping
Copeaux Courts



6
MATERIALES DUROS
Hard Materials
Matériaux Durs

D mm	d mm	L mm	l mm	Dentado Teeth / Denture 1		Dentado Teeth / Denture 3		Dentado Teeth / Denture 4		Dentado Teeth / Denture 6		Dentado Teeth / Denture M	
				Nº Art.	€	Nº Art.	€	Nº Art.	€	Nº Art.	€	Nº Art.	€
3,00	3,00	38,00	6,00	55733	13,69	44637	11,39	44648	13,69	44655	12,52		
6,00	6,00	50,00	10,00	55735	25,65	44640	21,34	44650	25,65	44657	23,49		
6,30	3,00	42,00	9,50	55734	21,34	44638	17,81	44649	21,34	44656	19,57		
8,00	6,00	60,00	15,00	55737	29,04	44643	24,21	44651	29,04	44658	26,60		
9,60	6,00	61,00	16,00	44634	34,17	44644	28,49	44652	34,17	44659	31,31	20652	31,31
12,70	6,00	67,00	22,00	44635	42,71	44646	35,59	44653	42,71	44660	39,15	20653	39,15
12,70	8,00	67,00	22,00	55746	45,92	55743	38,33			55744	42,14		
16,00	6,00	70,00	25,00	55738	59,79	44647	49,82	44654	59,79	44661	54,82		
16,00	8,00	70,00	25,00	55749	63,83	55747	53,24			55748	58,56		
19,00	6,00	70,00	25,00	55741	85,73	55739	71,49			55740	78,64		

Ref. **9237**

FRESA ROTATIVA MD TIPO E GOTA LARGA

Long Oval E Type HM Rotary Burr
Fraise lime rotative carbure type E ovale longue



MD
HM
Carbure

Tipo
E
Type

Norma
TRE
Norm

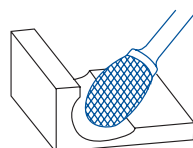
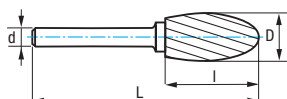

3
USO GENERAL
General Purpose
Utilisation Générale



6
MATERIALES DUROS
Hard Materials
Matériaux Durs

D mm	d mm	L mm	l mm	Dentado Teeth / Denture 3		Dentado Teeth / Denture 6	
				Nº Art.	€	Nº Art.	€
9,60	6,00	168,00	16,00	55849	43,30	55851	47,63
12,70	6,00	184,00	22,00	55852	53,71	55854	59,09



Ref. **9258**

FRESA ROTATIVA MD TIPO D ESFÉRICA

Ball D Type HM Rotary Burr

Fraise lime rotative carbure type D sphérique



MD HM Carbure	MD/HM + ALTiN	Tipo D Type	Norma KUD Norm
----------------------------	---------------------	--------------------------	-----------------------------

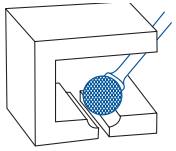
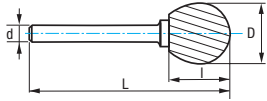

MATERIALES NO FERROSOS
Non-Ferrous Materials
Matériaux non ferreux



USO GENERAL
General Purpose
Utilisation Générale



VIRUTA CORTA
Short Chipping
Copeaux Courts

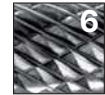

MATERIALES DUROS
Hard Materials
Matériaux Durs

D mm	d mm	L mm	I mm	Dentado Teeth / Denture 1		Dentado Teeth / Denture 1 ALTiN		Dentado Teeth / Denture 3		Dentado Teeth / Denture 4		Dentado Teeth / Denture 6		Dentado Teeth / Denture 6 ALTiN	
				Nº Art.	€	Nº Art.	€	Nº Art.	€	Nº Art.	€	Nº Art.	€	Nº Art.	€
3,00	3,00	38,00	2,50	55713	12,63			44705	10,52	44712	12,63	44719	11,54	66498	16,69
6,00	6,00	50,00	4,70	55716	23,66			44707	19,70	44714	23,66	44721	21,67	66499	26,88
6,30	3,00	38,00	5,00	55714	19,70			44706	16,44	44713	19,70	44720	18,07		
8,00	6,00	52,00	6,00	55717	26,82			44708	22,35	44715	26,82	44722	24,53	66500	29,76
9,60	6,00	54,00	8,00	44662	29,96	55869	45,04	44709	24,96	44716	29,96	44723	27,43	66501	41,31
12,70	6,00	56,00	11,00	44671	37,86	55870	56,44	44710	31,52	44717	37,86	44724	34,69	66502	51,80
12,70	8,00	56,00	11,00	55728	34,74			55725	28,96			55726	31,87		
16,00	6,00	59,00	14,00	58481	53,35			44711	44,65	44718	53,60	44725	48,95		
16,00	8,00	59,00	14,00	55732	43,05			55729	35,90			55731	39,50		
19,00	6,00	62,00	16,50	55720	59,42			55718	49,55			55719	54,52		
25,00	6,00	67,00	22,00	55724	102,08			55722	85,14			55723	93,65		

New!



INOXIDABLES
Stainless Steels
Aciers Inox

D mm	d mm	L mm	I mm	Dentado Teeth / Denture M	
				Nº Art.	€
9,60	6,00	54,00	8,00	20081	27,43
12,70	6,00	56,00	11,00	20082	34,69

Ref. **9238**

FRESA ROTATIVA MD TIPO D ESFÉRICA LARGA

Long Ball D Type HM Rotary Burr

Fraise lime rotative carbure type D sphérique longue



MD HM Carbure	Tipo D Type	Norma KUD Norm
----------------------------	--------------------------	-----------------------------

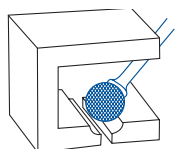
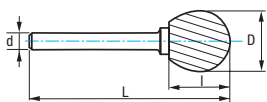

USO GENERAL
General Purpose
Utilisation Générale



MATERIALES DUROS
Hard Materials
Matériaux Durs

D mm	d mm	L mm	I mm	Dentado Teeth / Denture 3		Dentado Teeth / Denture 6	
				Nº Art.	€	Nº Art.	€
8,00	6,00	182,00	6,00	55841	36,46	55842	40,10
9,60	6,00	170,00	8,00	55843	37,06	55845	40,77
12,70	6,00	175,00	11,00	55846	45,43	55848	49,98



Ref. **9266**

FRESA ROTATIVA MD TIPO H LLAMA

Flame H Type HM Rotary Burr

Fraise lime rotative carbure type H flamme



MD HM Carbure	Tipo H Type	Norma B Norm
----------------------------	--------------------------	---------------------------

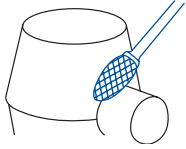
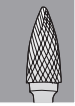
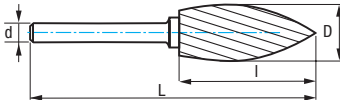

1
MAT. NO FERROSOS
Non-Ferrous Mat.
Mat. non ferreux



3
USO GENERAL
General Purpose
Utilisation Générale



4
VIRUTA CORTA
Short Chipping
Copeaux Courts



6
MATERIALES DUROS
Hard Materials
Matériaux Durs

D mm	d mm	L mm	I mm	Dentado Teeth / Denture 1		Dentado Teeth / Denture 3		Dentado Teeth / Denture 4		Dentado Teeth / Denture 6	
				N° Art.	€	N° Art.	€	N° Art.	€	N° Art.	€
3,00	3,00	38,00	6,00			44728	9,75	44735	11,68	44757	10,71
6,00	3,00	43,00	10,00			44729	16,00	44736	19,17	44760	17,58
6,00	6,00	50,00	14,00			44730	20,30	44737	27,32	44763	25,06
8,00	6,00	64,00	19,00	55791	30,77	44731	25,65	44738	30,77	44766	28,18
9,60	6,00	65,00	19,00	44726	36,72	44732	30,59	44739	36,72	44769	33,65
12,70	6,00	77,00	32,00	44727	44,41	44733	37,04	44740	44,41	44771	40,71
12,70	8,00	77,00	32,00			55792	54,81			55793	60,29
16,00	6,00	81,00	36,00	44773	63,18	44734	52,66	44742	63,18	44772	57,93
16,00	8,00	81,00	36,00			55794	75,69			55795	83,29



Ref. **9267**

FRESA ROTATIVA MD TIPO L CÓNICA REDONDEADA

Ball Nosed Cone L Type HM Rotary Burr
Fraise lime rotative carbure type L conique rayon



MD
HM
Carbure

Tipo
L
Type

Norma
KEL
Norm

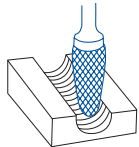
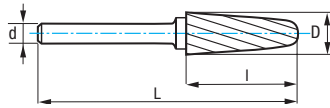

1
MAT. NO FERROSOS
Non-Ferrous Mat.
Mat. non ferreux



3
USO GENERAL
General Purpose
Utilisation Générale



4
VIRUTA CORTA
Short Chipping
Copeaux Courts



6
MATERIALES DUROS
Hard Materials
Matériaux Durs

D mm	d mm	L mm	l mm	Ang.	Dentado Teeth / Denture 1		Dentado Teeth / Denture 1 ALTIN		Dentado Teeth / Denture 3		Dentado Teeth / Denture 4		Dentado Teeth / Denture 6		Dentado Teeth / Denture 6 ALTIN	
					Nº Art.	€	Nº Art.	€	Nº Art.	€	Nº Art.	€	Nº Art.	€	Nº Art.	€
3,00	3,00	38,00	14,00	10°	55806	13,69			44776	11,39	44783	13,69	44790	12,52	66507	16,69
6,00	6,00	50,00	18,00	14°	55808	28,18			44778	23,49	44785	28,18	44792	25,82		
6,30	3,00	48,00	15,80	22°	55807	21,34			44777	17,81	44784	21,34	44791	19,60		
8,00	6,00	70,00	25,40	14°	55809	34,25			44779	28,49	44786	34,25	44793	31,31		
10,00	6,00	65,00	20,00	14°	21959	41,01			44780	34,17	44787	41,01	44794	37,54		
12,70	6,00	77,00	32,00	14°	44774	51,23	66508	62,67	44781	42,71	44788	51,23	44795	46,97	20159	57,50
12,70	8,00	77,00	32,00	14°	55812	47,94			55810	39,98			55811	43,98		
16,00	6,00	78,00	33,00	14°	44775	76,87			44782	64,05	44789	76,87	44796	70,47		
16,00	8,00	78,00	33,00	14°	55815	94,34			55813	78,68			55814	86,55		

Ref. **9247**

FRESA ROTATIVA MD TIPO L CÓNICA REDONDEADA LARGA

Long Ball Nosed Cone L Type HM Rotary Burr
Fraise lime rotative carbure type L conique rayon longue



MD
HM
Carbure

Tipo
L
Type

Norma
KEL
Norm



6
MATERIALES DUROS
Hard Materials
Matériaux Durs

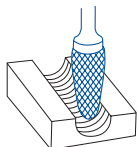
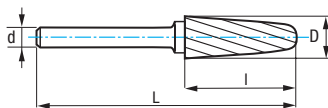

D mm	d mm	L mm	l mm	Ang.	Dentado Teeth / Denture 6	
					Nº Art.	€
9,60	6,00	183,00	30,00	14°	55858	57,95
12,70	6,00	185,00	30,20	14°	55860	65,19



Ref. **9268**

FRESA ROTATIVA MD TIPO F OJIVA REDONDEADA

Ball Nosed Tree F Type HM Rotary Burr
Fraise lime rotative carbure type F Ogive Rayon



MD HM Carbure	MD/HM + ALTIM	Tipo F Type	Norma RBF Norm
-----------------------------------	---------------------	--------------------------	-----------------------------

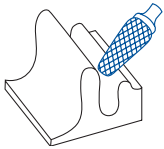
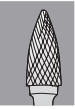
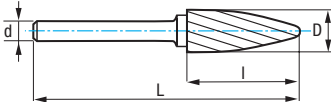

1
MATERIALES NO FERROSOS
Non-Ferrous Materials
Matériaux non ferreux



3
USO GENERAL
General Purpose
Utilisation Générale



4
VIRUTA CORTA
Short Chipping
Copeaux Courts



6
MATERIALES DUROS
Hard Materials
Matériaux Durs

D mm	d mm	L mm	l mm	Dentado Teeth / Denture 1		Dentado Teeth / Denture 1 ALTIM		Dentado Teeth / Denture 3		Dentado Teeth / Denture 4		Dentado Teeth / Denture 6		Dentado Teeth / Denture 6 ALTIM	
				Nº Art.	€	Nº Art.	€	Nº Art.	€	Nº Art.	€	Nº Art.	€	Nº Art.	€
3,00	3,00	38,00	14,00	55753	11,68			55750	9,75			17118	10,71	66503	16,69
6,00	6,00	50,00	18,00	55759	28,18			44797	23,49	44802	28,18	44808	25,82	66504	31,80
6,30	3,00	45,00	12,70	55758	19,17			55755	16,00			55756	17,58		
8,00	6,00	65,00	20,00	55760	34,17			44798	28,49	44803	34,17	44809	31,31		
9,60	6,00	64,00	19,00	55761	41,01	55880	42,96	44799	34,17	44804	41,01	44811	37,54	17250	39,42
12,70	6,00	70,00	25,00	55762	51,23	55881	59,01	44800	42,71	44805	51,23	44814	46,97	23849	54,16
12,70	8,00	70,00	25,00	55777	45,41			55774	37,87			55776	41,65		
16,00	6,00	70,00	25,00	55765	76,87			44801	64,05	44806	76,87	44817	70,47		
16,00	8,00	70,00	25,00	55782	62,70			55779	52,27			55780	57,52		
19,00	6,00	83,00	38,00	55771	121,87			55768	101,65			55769	111,79		

New!



M
INOXIDABLES
Stainless Steels
Aciers Inox

D mm	d mm	L mm	l mm	Dentado Teeth / Denture M	
				Nº Art.	€
9,60	6,00	64,00	19,00	20083	37,54
12,70	6,00	70,00	25,00	20085	46,97

Ref. **9248**

FRESA ROTATIVA MD TIPO F OJIVA REDONDEADA LARGA

Long Ball Nosed Tree F Type HM Rotary Burr
Fraise lime rotative carbure type F ogive rayon longue

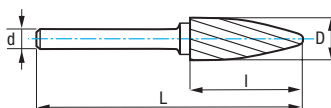

MD HM Carbure	Tipo F Type	Norma RBF Norm
-----------------------------------	--------------------------	-----------------------------



6
MATERIALES DUROS
Hard Materials
Matériaux Durs

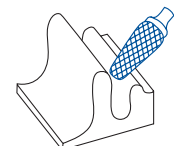

D mm	d mm	L mm	l mm	Dentado Teeth / Denture 6	
				Nº Art.	€
9,60	6,00	172,00	19,00	55855	45,37
12,70	6,00	178,00	25,00	55857	59,28



Ref. **9200**

JUEGOS FRESAS ROTATIVAS MD

HM Rotary Burr Sets

Jeux fraises limes rotatives carbure



Mod. 1
Set 5 Pcs



MAT. NO FERROSOS
Non-Ferrous Mat.
Mat. non ferreux



MATERIALES DUROS
Hard Materials
Matériaux Durs

Cont. (1 x ref.)	D mm	d mm	Dentado Teeth / Denture 1		Dentado Teeth / Denture 6	
			Nº Art.	€	Nº Art.	€
9260						
9251	12,70	6,00	60052	221,52	45810	203,24
9255						
9258	9,60	6,00			68857	153,61
9266						



Mod. 2
Set 10 Pcs



MATERIALES DUROS
Hard Materials
Matériaux Durs

Cont. (1 x ref.)	D mm	d mm	Dentado Teeth / Denture 6	
			Nº Art.	€
9260				
9250				
9251				
9254				
9255	6,00	6,00	45811	225,49
9257				
9258				
9266				
9267				
9268				



Mod. 3
Set 8 Pcs



MATERIALES DUROS
Hard Materials
Matériaux Durs

Cont. (1 x ref.)	D mm	d mm	Dentado Teeth / Denture 6	
			Nº Art.	€
9260				
9250				
9251				
9254	3,00	3,00	45813	95,68
9257				
9258				
9267				
9268				



Mod. 4
Set 3 Pcs



MATERIALES DUROS
Hard Materials
Matériaux Durs

Cont. (1 x ref.)	D mm	d mm	Dentado Teeth / Denture 6	
			Nº Art.	€
9260				
9251	9,60	6,00	79826	97,83
9254				



New!
Mod. 5
Set 5 Pcs



INOXIDABLES
Stainless Steels
Aciers Inox

Cont. (1 x ref.)	D mm	d mm	Dentado Teeth / Denture M	
			Nº Art.	€
9251				
9254	12,70	6,00	84379	206,93
9257				
9258	9,60	6,00	84380	161,25
9268				



Expo - Ref. 9200



Set 48 Pcs

Nº Art.	€
57079	1.555,06

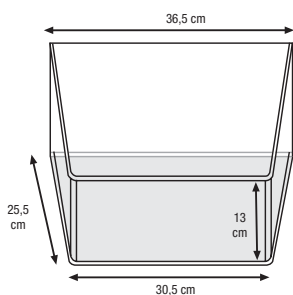

Dentado
Teeth / Denture
6

Ref.	Diam. mm	Nº Art.	Uds
9260	06,00X06,00	44141	2
	08,00X06,00	44142	2
	09,60X06,00	44143	2
	12,70X06,00	44144	2
9251	06,00X06,00	44438	2
	08,00X06,00	44439	2
	09,60X06,00	44440	2
	12,70X06,00	44441	2
9254	06,00X06,00	44488	2
	08,00X06,00	44494	2
	09,60X06,00	44500	2
	12,70X06,00	44512	2
9258	06,00X06,00	44721	2
	08,00X06,00	44722	2
	09,60X06,00	44723	2
	12,70X06,00	44724	2
9267	06,00X06,00	44792	2
	08,00X06,00	44793	2
	10,00X06,00	44794	2
	12,70X06,00	44795	2
9268	06,00X06,00	44808	2
	08,00X06,00	44809	2
	09,60X06,00	44811	2
	12,70X06,00	44814	2

Línea 33 cm - Ref. 9200



Ref	9251	9251	9251	9251	9260	9260
Diam	6×6	8×6	9,6×6	12,7×6	9,6×6	12,7×6
Dent./Teeth	6	6	6	6	6	6
Pcs.	2	2	2	2	2	2

Ref. 4995 - Nº Art. 71009: 424,32 €



JUEGOS FRESAS ROTATIVAS MD CALIDAD PROFESIONAL
 Professional Quality HM Rotary Burr Sets
 Jeux fraises limes rotatives carbure qualité professionnelle



6 Sets

Nº Art.	€
58925	746,61

Set 8 Pcs

Nº Art.	€
58922	130,98

Cont.

Tipo Type	Ø
D	6-10
C	6-10
F	10-12
B	10-12



6 Sets

Nº Art.	€
58928	833,73

Set 10 Pcs

Nº Art.	€
58920	146,27

Cont.

Tipo Type	Ø
D	8
C	6-10
B	6-10
F	6-10
L	6-10
E	6-10



Ref. **9674**

FRESA RANURADO ALUCOBOND / DIBOND

Alucobond / Dibond Sheet Bending End Mill
Fraise rainurage Alucobond/Dibond



MD
HM
Carbure

IZAR
Std.



12000-
15000
rpm

Vf: 400-600
mm/min

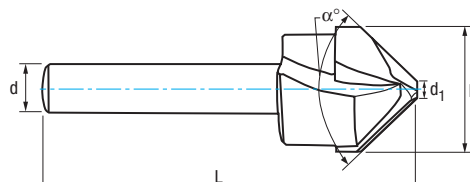

90°



2,5 mm

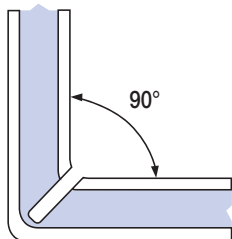
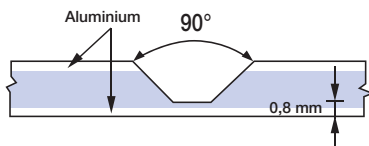

135°



2,3 mm

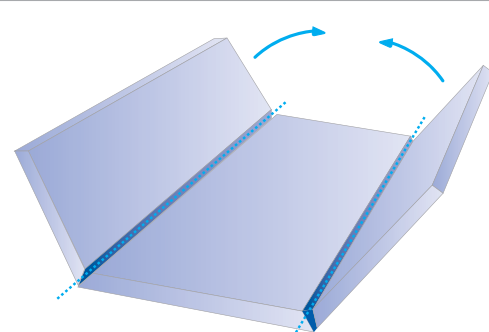
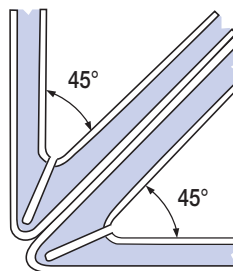
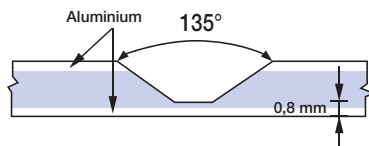

- Fresa especial para ranurados en Alucobond, Dibond, Durabond, Alupanel, Plexiglas, Alpolic, ACP, ACM...
- Se recomienda cortar casi hasta el fondo para poder doblar las planchas fácilmente.
- Special end mill for bending sheets of Alucobond, Dibond, Durabond, Alupanel, Plexiglas, Alpolic, ACP, ACM...
- The material should be cut almost until the bottom part leaving little amount of material left, that way the sheet will be bended easily.
- Fraise spéciale pour rainurage sur Alucobond, Dibond, Durabond, Alupanel, Plexiglas, Alpolic, ACP, ACM...
- Il est recommandé de couper presque jusqu'au fond pour pouvoir plier les plaques facilement.

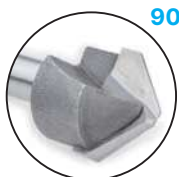

90°



135°

D mm	d mm	L mm	d ₁ mm	α °	N° Art.	€
α=90°						
16	8	59	2,5	90	81516	51,56
18	8	59	2,5	90	81519	52,29
20	8	59	2,5	90	81520	53,72

D mm	d mm	L mm	d ₁ mm	α °	N° Art.	€
α=135°						
16	8	59	2,3	135	81521	51,56
18	8	59	2,3	135	81522	52,29
20	8	59	2,3	135	81523	53,72



Ref. **9459**

FRESA 1Z GRABADO

1Z Engraving End Mill
Fraise 1Z gravure

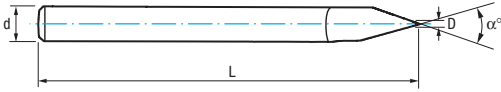

MD/HM/
Carbure
Micrograno

DIN
6535 HA

1Z

IZAR
std.

6000-
10000
r.p.m.

Aceros
<850 N/mm²
Steel / Aciers

Cobre
Copper
Cuivre

Aluminio
Aluminium

Plásticos
Plastics
Plastiques

Madera
Wood
Bois

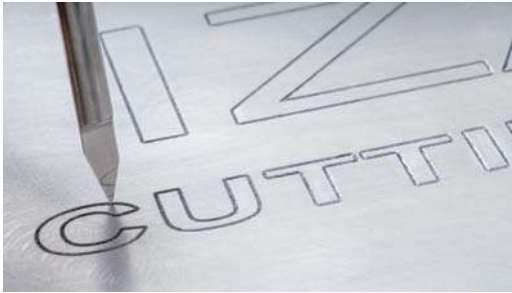

- **Afilado especial para grabado de metales, plásticos y maderas como: Aluminio, Cobre, Hierro, PVC, ABS, Metacrilato acrílico, Paneles bicolores, Madera MDF, etc.**
- **Specially designed geometry for engraving on Metal, Plastic and Wood. Valid for Aluminum, Copper, Iron, PVC, ABS, Acrylic, Bi-color panel, MDF fibreboard, etc.**
- **Géométrie spécial pour gravure de métaux, plastiques et bois telles que: Aluminium, cuivre, fer, PVC, ABS, méthacrylate acrylique, panneaux bicolores, bois MDF, etc.**

D	d	L	N°	€	D	d	L	N°	€	D	d	L	N°	€	D	d	L	N°	€
mm	mm	mm	Art.		mm	mm	mm	Art.		mm	mm	mm	Art.		mm	mm	mm	Art.	
α=30°																			
0,1	3,00	38	81048	8,80	0,1	3,00	38	81052	8,80	0,1	3,00	38	81055	8,80	0,1	3,00	38	81058	8,80
0,2	3,00	38	81049	8,80	0,2	3,00	38	81053	8,80	0,2	3,00	38	81056	8,80	0,2	3,00	38	81059	8,80
0,4	3,00	38	81050	8,80	0,2	4,00	45	81062	11,63	0,2	4,00	45	81065	11,63	0,2	4,00	45	81068	11,63
0,8	3,00	38	81051	8,80	0,2	6,00	50	81071	18,59	0,2	6,00	50	81080	18,59	0,2	6,00	50	81084	18,59
					0,4	3,00	38	81054	8,80	0,4	3,00	38	81057	8,80	0,4	3,00	38	81060	8,80
					0,4	4,00	45	81063	11,63	0,4	4,00	45	81066	11,63	0,4	4,00	45	81069	11,63
					0,4	6,00	50	81072	18,59	0,4	6,00	50	81081	18,59	0,4	6,00	50	81086	18,59
					0,8	4,00	45	81064	11,63	0,8	4,00	45	81067	11,63	0,8	4,00	45	81070	11,63
					0,8	6,00	50	81077	18,59	0,8	6,00	50	81082	18,59	0,8	6,00	50	81088	18,59
					2,0	6,00	50	81079	18,59	2,0	6,00	50	81083	18,59	2,0	6,00	50	81089	18,59

ALTIN bajo demanda / upon request / sur demande



Set 4 Pcs



Cont. D mm	N° Art.	€
0,1 mm 30° 0,2 mm 30° 0,4 mm 30° 0,8 mm 30°	81958	33,46

Cont. D mm	N° Art.	€
0,1 mm 30° 0,1 mm 45° 0,1 mm 60° 0,1 mm 90°	81959	33,46



Ref. **9419**

FRESA FRONTAL ACABADO METAL DURO 1Z ALTO RENDIMIENTO

High Performance 1Z HM Finishing End Mill
Fraise finition carbure 1Z haut rendement



MD/HM
Carbure
Micrograno+

ALTIN

W



Tol.
D (h10)
d (h6)



ALTIN

Mayor resistencia al desgaste
Higher Wear Resistance
Plus haute à l'usure



Aluminio
Aluminium

Plásticos
Plastics
Plastiques

D mm	d mm	L mm	I mm	Z	Nº Art. MD/HM	€	Nº Art. ALTIN	€
3,00	3,00	38	12	1	58984	13,98	59195	21,41
4,00	4,00	40	15	1	58856	17,01	59196	24,33
5,00	5,00	50	16	1	58857	21,03	59197	28,15
6,00	6,00	50	18	1	58859	24,98	59198	31,91
8,00	8,00	63	22	1	58860	37,91	59199	45,50
10,00	10,00	72	30	1	58862	53,00	59201	59,70



Ref. **9411**

FRESA FRONTAL 1Z ALUMINIO METAL DURO

HM Aluminium 1Z End Mill
Fraise 1Z Aluminium carbure



MD/HM
Carbure
Micrograno+

ALTIN

W



Tol.
D (h10)
d (h6)



ALTIN

Mayor resistencia al desgaste
Higher Wear Resistance
Plus haute à l'usure



Aluminio
Aluminium

Plásticos
Plastics
Plastiques

D mm	d mm	L mm	I mm	Z	Nº Art. MD/HM	€	Nº Art. ALTIN	€
3,00	3,00	38	12	1	13075	13,98	13114	21,41
4,00	4,00	40	12	1	13078	17,01	13123	24,33
5,00	5,00	50	12	1	13084	21,03	13126	28,15
6,00	6,00	50	14	1	13096	24,98	13135	31,91
8,00	8,00	63	15	1	13105	37,91	13138	45,50
10,00	10,00	72	15	1	13111	53,00	13144	59,70



Ref. **4412**

FRESA FRONTAL ACABADO HSS 1Z ALUMINIO

Aluminium 1Z HSS Finishing End Mill
Fraise finition HSS 1Z Aluminium



HSS	IZAR Std. W	Serie Corta Short Length Série courte	DIN 1835 A	d= 8-10 mm	Tol.* D (k10) d (h6)	* $\varnothing D = \varnothing d \Rightarrow$ Tol. D (js14) d (h6)
------------	-------------------	--	---------------	---------------	----------------------------	--

Aluminio
Aluminium

Termoplásticos
Thermoplastics
Thermoplastiques



D mm	d mm	L mm	I mm	Z	Nº Art.	€
3,00	8	60	12	1	44087	12,36
4,00	8	60	12	1	44090	12,36
5,00	8	60	12	1	44093	12,36
6,00	8	60	14	1	44096	12,36
7,00	8	60	14	1	44099	15,10
8,00	8	80	15	1	44102	15,10
10,00	10	80	15	1	44105	15,53



Ref. **4414**

FRESA FRONTAL ACABADO HSS 1Z ALUMINIO

Aluminium 1Z HSS Finishing End Mill
Fraise finition HSS 1Z Aluminium



HSS	IZAR Std. W	Serie Larga Long Series Série longue	DIN 1835 A	d= 8-10 mm		Tol.* D (k10) d (h6)	* $\varnothing D = \varnothing d \Rightarrow$ Tol. D (js14) d (h6)
------------	-------------------	---	---------------	---------------	---	----------------------------	--

Aluminio
Aluminium

Termoplásticos
Thermoplastics
Thermoplastiques



D mm	d mm	L mm	I mm	Y mm	Z	Nº Art.	€
4,00	8	80	16	29	1	44120	17,47
5,00	8	80	16	29	1	44123	17,47
6,00	8	90	16	29	1	44126	17,47
8,00	8	100	28	40	1	44129	19,39
10,00	10	120	40	40	1	29178	19,98



HOJAS DE SIERRA DE CINTA

Band Saw Blades

Lames de scie à ruban

SELECCIÓN DE LA HOJA CORRECTA

Selecting the right Blade / Selection adaptée

1. Longitud de la Cinta (L)

La dimensión de la cinta depende únicamente de la máquina de corte empleada.

1. Band Length (L)

The band dimension individually depends on the used cutting machine.

1. Longueur de Lame (L)

La dimension d'une lame dépend de la machine utilisée.

2. Ancho de la Cinta (A)

En las máquinas horizontales la anchura de la cinta es especificada por el fabricante. Las máquinas verticales permiten mayores variaciones en la anchura de la cinta.

Sin embargo, la norma general es que cuanto más ancha es la hoja de sierra de cinta, mayor es su estabilidad.

Para el corte de contornos, el radio más pequeño a cortar limita el ancho de la cinta.

2. Band Width (A)

With horizontal machines the band width is specified by the manufacturer.

Vertical band saw machines allow higher variations of the band width.

However, the general rule is the wider the band saw blade the higher its stability.

In case of contour cuts the smallest radius to be cut is the limiting factor for the band width.

2. Largeur de la Lame (A)

Sur des machines horizontales, la largeur de la lame est spécifiée par le fabricant.

Les machines verticales permettent de plus grandes variations dans les largeurs de lames.

La règle est généralement la suivante: Plus la lame est large, plus la rigidité est importante.

En cas de contournage, la largeur du ruban est limitée par le plus petit rayon à scier.

3. Espesor de la Cinta (E)

Cuanto más ancha es la hoja de sierra de cinta, mayor es su espesor.

3. Band Thickness (E)

The wider the band saw blade the higher its thickness.

3. Epaisseur de Lame (E)

Plus la lame est large, plus la épaisseur est importante.

4. Dentado (TPI)

El dentado es el nº de dientes por pulgada (25,4 mm).

Los dentados se diferencian en constantes, paso de diente uniforme, y variables, con diferente paso de diente dentro de cada intervalo.

Los dentados variables se definen con dos medidas, p.e. 2-3 TPI: 2 TPI significa el paso de diente máximo, y 3 TPI significa el paso de diente mínimo en el intervalo de dentado.

Aquí, la longitud de contacto de la sierra de cinta con la pieza a cortar es decisiva.

4. Tooth pitch (TPI)

Tooth pitch is the number of teeth per inch (25,4 mm).

A difference is made between constant tooth pitches with regular tooth distance and variable tooth pitches with differing tooth distance within one interval.

Variable tooth pitches are marked by two measures, e.g. 2-3 TPI: 2 TPI signifies the maximum tooth distance and 3 TPI signifies the minimum tooth distance in the toothing interval.

Here the contact length of the blade in the work piece is decisive.

4. Dentures (TPI)

La dentura es el nº de dientes por pulgada (25,4 mm).

Una diferencia reside entre las denturas constantes, o el écart entre dos puntas de dientes reste égal y las denturas variables, o les valeurs des pas de dents sont différents.

La dentura variable est caractérisée par deux chiffres, p.e. 2-3 TPI: 2 TPI désigne l'écart maxi entre les dents et le chiffre 3 TPI l'écart mini entre les dents sur une séquence de denture.

La surface de contact de la lame sur la pièce à débiter est décisive.

5. Forma Diente (TZ)

Diente estándar (S)

Angulo desprendimiento 0°:

- materiales de viruta corta
- aceros de alto contenido en carbono
- preferiblemente acero de herramienta y hierro fundido
- materiales de poca sección de corte
- perfiles de pared delgada

5. Tooth Shape (TZ)

Raker tooth (S)

0° rake angle for:

- short-chipping materials
- steels with high carbon content
- preferably tool steel and cast iron
- materials with small cross-sections
- thin-walled profiles

Diente de garra (K)

Angulo de desprendimiento positivo para macizos:

- empleo universal
- metales no ferrosos y aceros con un contenido en carbono de < 0,8%
- aceros estructurales, aceros para extrusión en frío y aceros templados

Hook tooth (K)

Positive rake angle for solids:

- universal use
- non-ferrous metals and steels with a carbon content of < 0,8%
- structural steels, steels for cold extrusion, tempered steels

5. Forme de Dent (TZ)

Dent standard (S)

Angle de coupe 0° pour:

- matériaux à copeaux courts
- aciers à forte teneur en carbone
- les fontes et aciers à outil
- pièces de petites sections
- profils à parois minces

Dent griffe (K)

Angle de coupe positif pour matériaux pleins:

- usage universel
- métaux non ferreux et aciers à teneur en carbone de < 0,8%
- aciers de construction, aciers pour extrusion à froid et aciers trempés

Ancho cinta y radio más pequeño

Band widths and smallest radius

Largeurs de lames et plus petit rayon

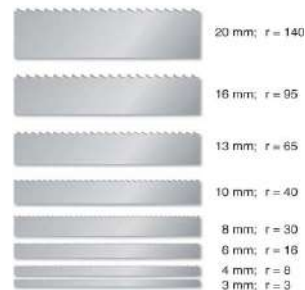

Dentado constante

Constant tooth pitch

Denture constante



Dentado variable

Variable tooth pitch

Denture variable



Tabla selección dentado

Tooth selection table

Tableau sélection denture

Dentado Tooth Denture	Perfil Profile Profil	Macizo Solid Plein
10 / 14	0-1 mm	0-10 mm
8 / 12	1-2,5 mm	10-20 mm
6 / 10	2,5-5 mm	20-40 mm
5 / 8	5-7 mm	40-50 mm
4 / 6	7-10 mm	50-90 mm
3 / 4	>10 mm	90-120 mm
2 / 3		>120 mm
1,4 / 2		>250 mm

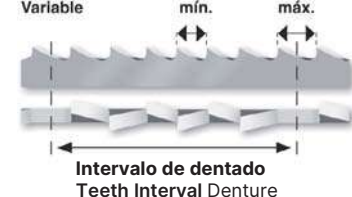

Positivo

Positive



Ref. **4223**

HOJA DE SIERRA DE CINTA HSSE 8% Co IZARFLEX

IZARFLEX HSSE 8% Co Band Saw Blade

Lame de scie à ruban HSSE 8% Co IZARFLEX

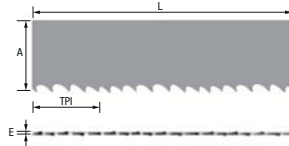

**HSSE
8% Co**

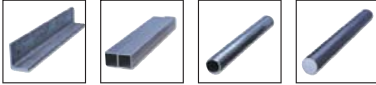

**Aceros
<850 N/mm²
Steel / Aciers**

**Aceros
<1000 N/mm²
Steel / Aciers**

**Cobre
Copper
Cuivre**

**Aluminio
Aluminium**

**Plásticos
Plastics
Plastiques**

Idéal para trabajos de taller exigentes, con los dientes de una calidad especial resistente al desgaste. Fleje flexible, bimetál, combina dentados 0 y +

Idéal for heavy duty workshop cutting tasks, with special wear resistant quality teeth. Flexible strip, bimetal, 0 & + teeth combined.

Idéal pour des travaux d'atelier exigeants, avec dents d'une qualité spéciale résistante à l'usure. Feuillard Flexible, bimétal, possibilité dentures 0 et +

New!

L mm	A mm	E mm		€ 1 ud.
1030	13	0,65	3	18,01
1080				18,89
1104				19,30
1115				19,50
1125				19,67
1130				19,79
1138				19,89
1140				19,94
1270				21,00
1300				21,50
1310				21,59
1325				21,71
1328				21,73
1330				21,76
1335				21,78
1340				21,85
1350				21,99
1365				22,06
1385				22,24
1400				22,48
1410				23,05
1425				22,89
1435				23,05
1440				23,13
1445				23,20
1450				23,26
1460				23,83
1470				24,41
1480				24,42
1490				24,59
1514				24,69
1525				24,73
1550				24,86
1575				24,99
1580				25,03
1600				25,14
1620				25,26
1630				25,30
1635				25,40
1638				25,44
1640				25,46
1645				25,52
1650				25,61
1660				25,78
1710				26,18
1715				26,25

New!

L mm	A mm	E mm		€ 1 ud.
1718	13	0,65	3	26,31
1728				26,46
1730				26,49
1735				26,56
1740				26,64
1745				26,73
1750				26,80
1770				27,12
1790				27,42
1838				28,15
1840				28,17
1845				28,25
1875				28,72
2100				29,23
2120				29,51
2125				29,58
2150				29,92
2230				31,04
2240				31,16
2242				31,20
2250				31,31
2290				31,87
2390				32,42
2440				33,11
2490				33,79
2500				33,93
2550				34,60
2560				34,70
2580				35,01
2650				35,62
2735				36,36
2750				36,55
2800				37,05
2840				37,54
2845				37,62
2890				38,24
2900				38,36
3115				40,57
3140				40,86
3160				41,09
3200				41,52
3355				43,25
3370				43,44
3420				44,08
3430				44,22
3590				46,28

New!

L mm	A mm	E mm		€ 1 ud.
3600	13	0,65	3	46,41
3830				48,46
3857				48,80
4100				50,23
4180				51,21
4400				53,80
4440				54,22
4600				56,23
5140				62,83
1350	20	0,90	2	24,01
1710				28,94
1735				29,36
1740				29,45
1750				29,61
2000				31,78
2005				32,71
2010				33,65
2020				33,80
2035				34,22
2037				34,28
2040				34,32
2058				34,65
2060				34,67
2065				34,73
2070				34,78
2075				34,87
2080				34,94
2085				34,99
2090				35,07
2095				35,13
2100				35,18
2110				35,34
2115				35,42
2120				35,50
2130				39,52
2140				35,76
2215				36,64
2225				36,79
2240				37,06
2265				37,45
2300				38,04
2350				38,59
2355				38,68
2360				38,75
2362				38,77
2365				38,83

New!

L mm	A mm	E mm		€ 1 ud.
2370	20	0,90	2	38,90
2375				38,95
2380				39,06
2400				39,37
2450				39,93
2465				40,18
2470				40,26
2480				40,43
2490				40,59
2520				40,92
2530				41,07
2540				41,23
2542				41,26
2560				41,55
2600				42,21
2610				42,36
2625				42,61
2630				42,69
2650				43,01
2665				43,27
2710				44,00
2750				44,64
2770				44,96
2950				45,93
2970				46,05
2980				46,11
3000				46,23
3084				46,64
3240				47,51
3280				48,10
3454				50,24
3950				55,89
3960				56,30
4000				56,87
4185				59,20
4270				60,41
4400				62,25
4485				63,46
4665				65,99
4700				66,49
4900				69,32
5130				72,58
5800				78,72
7220				102,15
7320				103,56







Ref. **4223**

HOJA DE SIERRA DE CINTA HSSE 8% Co IZARFLEX

IZARFLEX HSSE 8% Co Band Saw Blade

Lame de scie à ruban HSSE 8% Co IZARFLEX

New!					New!					New!					New!				
L	A	E		€	L	A	E		€	L	A	E		€	L	A	E		€
mm	mm	mm	1 ud.	1 ud.	mm	mm	mm	1 ud.	1 ud.	mm	mm	mm	1 ud.	1 ud.	mm	mm	mm	1 ud.	1 ud.
2060	27	0,90	2	35,26	2795	27	0,90	2	45,73	3320	27	0,90	2	53,20	5035	27	0,90	2	74,10
2070				35,44	2800				45,81	3345				53,61	5060				74,47
2080				35,59	2810				45,99	3350				53,69	5090				74,86
2085				35,68	2820				46,15	3352				53,72	5170				76,03
2090				35,85	2825				46,23	3365				53,94	5430				79,50
2100				35,98	2830				46,30	3370				54,02	5445				79,71
2110				36,09	2835				46,38	3378				54,15	5600				84,56
2140				36,44	2840				46,44	3380				54,17	5725				86,45
2145				36,52	2845				46,53	3400				54,45	6200				91,81
2150				36,60	2847				46,57	3420				54,72	6500				96,24
2155				36,71	2850				46,62	3430				54,87	7400				106,28
2355				39,33	2855				46,70	3435				54,95	2600	34	1,10	1	49,37
2360				39,41	2860				46,77	3440				55,03	2620				49,74
2375				39,64	2865				46,82	3460				55,20	2630				49,92
2400				40,06	2870				46,88	3490				55,50	2970				56,38
2410				40,22	2880				46,96	3495				55,54	3505				66,26
2440				40,72	2884				47,02	3500				55,62	3530				66,74
2445				40,80	2890				47,10	3505				55,69	3634				68,71
2448				40,85	2900				47,26	3550				56,41	3655				69,10
2450				40,88	2910				47,45	3560				56,58	3660				69,20
2455				40,95	2915				47,50	3600				57,21	3730				70,52
2459				41,00	2920				47,58	3630				57,68	3770				71,28
2460				41,01	2925				47,66	3640				57,83	3780				71,46
2465				41,10	2927				47,69	3650				58,00	3800				71,84
2470				41,17	2930				47,74	3660				58,16	3820				72,22
2480				41,30	2940				47,83	3667				58,27	3830				72,41
2485				41,39	2945				47,92	3670				58,32	3840				72,59
2500				41,65	2950				48,02	3700				58,80	3851				72,80
2515				41,90	2960				48,17	3800				60,15	3870				73,16
2520				41,98	2964				48,25	3810				60,31	3880				73,25
2535				42,09	2965				48,26	3820				60,46	3920				73,63
2540				42,12	2985				48,46	3830				60,62	4020				74,83
2550				42,29	3000				48,72	3850				60,93	4030				75,01
2560				42,44	3010				48,88	3851				60,96	4100				76,32
2565				42,52	3015				48,96	3853				60,98	4115				76,57
2570				42,59	3020				49,02	3900				61,73	4120				76,64
2580				42,75	3025				49,11	3930				62,20	4130				76,84
2590				42,82	3035				49,29	3950				62,51	4160				77,39
2600				43,01	3050				49,52	4000				63,30	4180				77,77
2615				43,27	3084				49,87	4038				63,71	4200				78,14
2625				43,44	3090				50,00	4050				63,82	4250				79,07
2645				43,58	3100				50,17	4079				64,11	4260				79,26
2655				43,65	3110				50,29	4090				64,28	4300				80,01
2660				43,72	3120				50,46	4100				64,44	4335				80,29
2680				44,18	3140				50,72	4115				64,67	4340				80,38
2700				44,44	3150				50,87	4150				64,86	4350				80,57
2710				44,62	3160				51,03	4240				65,31	4370				80,95
2715				44,70	3175				51,24	4250				65,36	4380				81,13
2720				44,79	3180				51,32	4270				65,47	4400				81,50
2725				44,87	3200				51,64	4310				65,66	4420				81,85
2730				44,94	3215				51,87	4470				66,46	4440				82,24
2735				45,02	3220				51,96	4500				66,83	4470				82,79
2740				45,10	3230				52,12	4590				68,17	4520				83,33
2750				45,16	3250				52,44	4600				68,31	4570				84,23
2755				45,24	3270				52,56	4870				71,85	4600				84,79
2759				47,28	3280				52,62	4875				71,91	4610				84,98
2760				45,30	3285				52,65	4900				72,29	4640				85,53
2765				45,36	3300				52,89	4960				73,08	4670				86,09
2770				45,45	3310				53,03	5000				73,59	4720				86,81



Ref. **4223**

HOJA DE SIERRA DE CINTA HSSE 8% Co IZARFLEX

IZARFLEX HSSE 8% Co Band Saw Blade

Lame de scie à ruban HSSE 8% Co IZARFLEX

Cont.

New!

L mm	A mm	E mm		€ 1 ud.
4750	34	1,10	1	87,23
4770				87,59
4780				87,79
4800				88,15
4900				89,69
4930				90,24
4970				90,99
4990				91,36
5000				91,54
5070				92,79
5080				92,98
5090				93,15
5150				94,08
5200				94,87
5270				96,15
5320				97,07

New!

L mm	A mm	E mm		€ 1 ud.
5400	34	1,10	1	98,52
5500				100,33
5600				102,17
5700				104,01
5720				104,37
5800				105,82
6000				106,88
6060				107,95
6340				108,71
6350				108,89
6360				109,08
7000				119,35
7002				119,36
7010				119,52
8730				148,85

New!

L mm	A mm	E mm		€ 1 ud.
4115	41	1,30	1	109,26
4500				119,49
4570				121,34
4650				122,79
4670				123,32
4800				126,25
4930				129,16
5000				130,99
5090				133,34
5200				136,23
5334				139,74
5400				141,47
5450				142,77
5500				144,09
5600				146,70
5700				148,61

New!

L mm	A mm	E mm		€ 1 ud.
5800	41	1,30	1	150,50
5920				153,62
5940				154,14
6192				160,70
6300				162,75
6500				166,83
6600				169,38
6675				171,31
6775				173,87
6800				174,51
6990				179,41
7250				185,95
7400				189,80
7470				191,60
7880				202,12

Tipo Dentado (TZ) / Teeth Type (TZ) / Type Denture (TZ)

A x E	TPI									
	2	2-3	3	3-4	4	4-6	5-8	6-10	8-12	10-14
13 x 0,65								S	S	S
20 x 0,90										
27 x 0,90	K		K	K	K	K	S	S	S	S
34 x 1,10		K	K	K		K	S	S	S	
41 x 1,30		K		K		K				

Rollos sin Soldadura
Rolls without Welding
Rouleaux non soudées

L mm	A mm	E mm	8% Co €
30500	13	0,65	338,96
100000	20	0,90	1.220,26
100000	27	0,90	1.297,60
100000	34	1,10	1.533,93
75000	41	1,30	1.675,73



Unidades pedido mínimo
Minimum order units
Unités commande minimale

Ejemplo Pedido / Order Example / Exemple Commande

Ref. 4223 + L 2450 + A 27 + E 0,90 + TPI 6-10 + TZ S



Ref. **4228**

HOJA DE SIERRA DE CINTA HSSE 8% Co + 4% Cr IZARPLUS

IZARPLUS HSSE 8% Co + 4% Cr Band Saw Blade

Lame de scie à ruban HSSE 8% Co + 4% Cr IZARPLUS

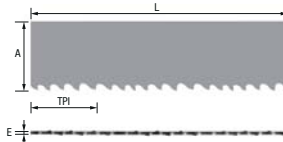

Aceros <850 N/mm ² Steel / Aciers	Aceros <1000 N/mm ² Steel / Aciers	Fundición Cast Iron Fonte	INOX Stainless Steel Acier INOX
Cobre Copper Cuivre	Aluminio Aluminium	Plásticos Plastics Plastiques	

Especial Perfiles. Dentado variable 0° adecuado para perfiles y tareas de corte en serie, susceptibles de vibraciones.

Special Profiles. Variable tooth pitch 0° for profiles and bundle sawing tasks, susceptible of vibrations.

Spécial profils. Denture variable 0° convenable pour profils et travaux de coupe en paquet, susceptibles des vibrations.

New!

New!

New!

New!

L mm	A mm	E mm		€ 1 ud.
1100	13	0,65	3	24,60
1130				25,27
1138				25,45
1140				25,48
1300				28,03
1310				28,24
1325				28,41
1330				28,54
1335				28,62
1338				28,69
1375				29,46
1470				31,51
1485				31,83
1638				33,43
1640				33,46
1645				33,58
1650				33,68
1680				34,29
1730				34,89
1732				34,93
1735				34,98
1740				35,04
1750				35,22
1974				39,73
2180				43,84
2240				45,04
2265				45,56
2900				58,31
3700				68,89
3800				70,74
3825				71,20
4180				75,21

L mm	A mm	E mm		€ 1 ud.
1125	13	0,90	3	25,15
1140				25,48
1325				28,41
1330				28,54
1335				28,62
1338				28,69
1375				29,46
1470				31,51
1485				31,83
1638				33,43
1640				33,46
1650				33,68
1735				34,98
1750				35,22
1840				37,05
2240				45,04

L mm	A mm	E mm		€ 1 ud.
1735	20	0,90	2	34,98
2000				37,51
2010				37,70
2035				37,98
2045				38,16
2060				38,45
2070				38,60
2080				38,76
2082				38,78
2085				38,84
2090				38,92
2100				39,09
2110				39,24
2130				39,52
2140				39,72
2150				39,89
2265				41,66
2360				43,13
2362				43,18
2370				43,29
2375				43,35
2400				43,74
2465				44,76
2480				45,04
2500				45,31
2520				45,60
2530				45,77
2600				47,05
2825				49,88
2960				52,27
2970				52,45
2980				52,62
3000				52,97

L mm	A mm	E mm		€ 1 ud.
2080	27	0,90	2	43,78
2100				43,81
2110				43,82
2145				43,88
2150				43,88
2190				44,69
2360				44,38
2375				44,39
2400				44,42
2430				44,47
2435				44,47
2440				44,48
2445				44,50
2450				44,59
2455				44,62
2460				44,64
2470				45,23
2480				45,79
2490				45,85
2500				45,88
2520				45,93
2535				46,00
2550				46,06
2560				46,19
2565				46,24
2570				46,34
2600				46,83
2640				47,10
2655				47,19
2660				47,29
2680				47,65
2700				48,41
2710				48,60
2715				48,60
2720				48,60
2730				48,64
2740				48,66
2745				48,70
2750				48,74
2755				48,84
2760				48,90
2765				48,96
2780				49,21
2800				49,47
2805				49,55
2820				49,81
2825				49,88



Ref. **4228**

HOJA DE SIERRA DE CINTA HSSE 8% Co + 4% Cr IZARPLUS

IZARPLUS HSSE 8% Co + 4% Cr Band Saw Blade

Lame de scie à ruban HSSE 8% Co + 4% Cr IZARPLUS

Cont.

New!					New!					New!					New!				
L	A	E		€	L	A	E		€	L	A	E		€	L	A	E		€
mm	mm	mm		1 ud.	mm	mm	mm		1 ud.	mm	mm	mm		1 ud.	mm	mm	mm		1 ud.
2830	27	0,90	2	49,93	3352	27	0,90	2	57,61	3320	34	1,10	1	75,22	5050	34	1,10	1	110,95
2835				49,96	3370				57,92	3505				79,41	5080				111,50
2840				49,97	3400				59,08	3660				81,76	5090				111,67
2845				49,98	3420				59,19	3730				83,34	5200				114,08
2850				50,05	3440				59,53	3770				84,23	5270				115,51
2860				50,05	3454				59,79	3800				84,90	5300				116,12
2865				50,06	3485				59,81	3820				85,34	6350				131,03
2870				50,06	3505				59,82	3860				86,23	6500				133,92
2885				50,07	3560				60,26	3910				87,30	6550				134,95
2900				50,07	3630				60,54	3920				87,53	7000				143,71
2910				50,24	3650				60,85	3950				88,21	7550				154,39
2920				50,36	3660				61,02	4020				89,76	8730				178,52
2925				50,47	3670				61,19	4030				89,99	4115	41	1,30	1	128,29
2927				50,50	3684				61,43	4100				91,56	4500				139,19
2930				50,55	3800				62,01	4120				92,02	4640				143,53
2950				50,85	3810				62,18	4160				92,92	4930				151,75
2965				51,13	3820				62,34	4250				94,49	5000				153,90
3000				51,76	3830				62,48	4335				96,40	5040				155,14
3010				51,92	3835				62,57	4380				97,42	5090				156,66
3025				52,19	3850				62,82	4400				97,86	5265				161,65
3035				52,37	3851				62,83	4420				98,30	5300				162,74
3080				54,87	3857				62,94	4450				98,74	5340				163,98
3090				55,05	3900				63,64	4470				99,18	5350				164,29
3100				55,22	3930				64,13	4500				99,78	5450				167,04
3110				55,25	4090				66,29	4520				100,18	5700				173,95
3120				55,28	4115				66,70	4570				101,20	5920				180,67
3135				55,32	4160				67,42	4610				101,96	6175				188,45
3140				55,33	4230				68,55	4620				102,20	6300				191,73
3150				55,35	4250				68,87	4640				102,63	6400				194,77
3160				55,38	4280				69,37	4780				105,50	6585				199,98
3180				55,43	4500				72,93	4800				105,95	6775				205,49
3200				55,78	4600				74,56	4930				108,49	6800				206,24
3270				56,20	4820				83,33	4970				109,38	6900				209,12
3300				56,71	4870				84,18	4990				109,78	7470				225,65
3320				57,05	4880				84,36	5030				110,52	7880				238,04
3335				57,32	5030				86,95	5040				110,74	8200				247,70
3340				57,39	5200				89,90										
3345				57,49															
3350				57,57															

Tipo Dentado (TZ) / Teeth Type (TZ) / Type Denture (TZ)

A x E	TPI					
	3-4	4-6	5-8	6-10	8-12	10-14
13 x 0,65				S	S	S
13 x 0,90				S	S	S
20 x 0,90		S	S	S	S	S
27 x 0,90	S	S	S	S	S	S
34 x 1,10	S	S	S	S	S	
41 x 1,30	S	S	S	S		

Rollos sin Soldadura / Rolls without Welding / Rouleaux non soudés

L	A	E	8% Co	L	A	E	8% Co
mm	mm	mm	€	mm	mm	mm	€
30500	13	0,65	426,03	100000	27	0,90	1.513,73
123000			1.716,73	134000			2.083,71
30500	13	0,90	426,03	100000	34	1,10	1.858,78
100000	20	0,90	1.456,48	75000	41	1,30	1.978,97

Unidades pedido mínimo
Minimum order units
Unités commande minimale

Ejemplo Pedido / Order Example / Exemple Commande Ref. 4228 + L 2080 + A 27 + E 0,90 + TPI 8-12 + TZ S



Ref. **4229**

HOJA DE SIERRA DE CINTA HSSE 8% Co + 4% Cr IZARPLUS

IZARPLUS HSSE 8% Co + 4% Cr Band Saw Blade

Lame de scie à ruban HSSE 8% Co + 4% Cr IZARPLUS

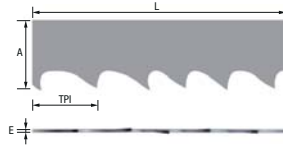

Aceros
<850 N/mm²
Steel / Aciers

Aceros
<1000 N/mm²
Steel / Aciers

INOX
Stainless Steel
Acier INOX

Cobre
Copper
Cuivre

Aluminio
Aluminium

Plásticos
Plastics
Plastiques

HSSE
8% Co

4% Cr



Especial Macizos. Dentado variable 10°. Mayores rendimientos de corte, ideal para el corte de piezas macizas grandes.

Special Solid Pieces. Variable tooth pitch 10°. Higher cutting performance, suitable to cut big solid pieces.

Spécial pièces pleins. Denture variable 10°. Rendements de coupe supérieurs, convenable pour la coupe de grandes pièces pleins.

New!

L mm	A mm	E mm	€ 1 ud.
2080	27	0,90	43,78
2150			43,89
2450			44,59
2455			44,61
2459			44,63
2460			44,64
2480			45,79
2550			46,06
2565			46,27
2570			46,34
2590			46,66
2600			46,83
2680			47,65
2700			48,41
2710			48,60
2720			48,65
2730			48,69
2740			48,72
2750			48,74
2755			48,84
2760			48,90
2765			48,96
2800			49,45
2825			49,88
2835			49,93
2845			49,98
2855			50,15
2910			50,24
2925			50,47
2950			50,85
3000			51,76
3010			51,92
3025			52,19
3035			52,37
3100			55,22
3105			55,24

New!

L mm	A mm	E mm	€ 1 ud.
3120	27	0,90	55,29
3140			55,34
3150			55,35
3160			55,37
3180			55,43
3200			55,82
3222			56,18
3240			56,49
3270			56,60
3300			56,71
3320			57,05
3345			57,49
3350			57,57
3352			57,61
3400			58,83
3420			59,19
3445			59,63
3495			60,32
3500			60,40
3505			60,49
3520			60,54
3550			60,66
3640			60,96
3660			61,02
3770			61,53
3800			62,01
3810			62,17
3820			62,34
3830			62,49
3900			63,64
3930			64,13
4090			66,29
4110			66,62
4115			66,70
4310			72,98
4500			75,94
4800			81,00

New!

L mm	A mm	E mm	€ 1 ud.
3350	34	1,10	72,63
3505			79,41
3770			84,22
3820			85,34
3850			86,01
4020			89,81
4100			91,59
4115			91,90
4120			92,01
4130			92,24
4160			92,91
4210			94,02
4220			94,25
4250			94,90
4335			96,40
4420			97,95
4440			98,41
4450			98,62
4470			99,07
4500			99,73
4520			100,19
4530			100,39
4570			101,20
4640			102,76
4720			104,16
4770			105,26
4780			105,50
4860			107,27
4865			107,36
4970			109,38
4990			109,78
5000			110,02
5090			111,99
5156			113,12
5200			114,08
5270			115,47
5300			116,12

New!

L mm	A mm	E mm	€ 1 ud.
4115	41	1,30	128,29
4500			139,19
4640			143,53
4650			143,82
4700			145,37
4900			150,83
4930			151,75
5000			153,88
5040			155,12
5080			156,35
5090			156,66
5340			163,98
5350			164,29
5450			167,34
5800			177,19
5890			179,77
5920			180,67
6040			184,34
6300			191,32
6500			197,40
6585			199,98
6675			202,71
6775			205,49
6800			206,24
6900			209,11
7470			225,65
8200			235,08
8400			240,71
5800	54	1,60	218,99
6040			231,98
6096			234,13
6200			240,61
6270			243,18
6500			251,61
7140			275,13
7200			277,33
7310			281,56
7450			286,45
7460			286,83
7545			289,89
7600			292,01
8900			349,87
9750			383,28

Tipo Dentado (TZ)
Teeth Type (TZ) / Type Denture (TZ)

A x E	TPI				
	1,4-2	2-3	3-4	4-6	5-8
27 x 0,90		K	K	K	K
34 x 1,10	K	K	K	K	K
41 x 1,30	K	K	K	K	K
54 x 1,60	K	K	K	K	



Unidades pedido mínimo
Minimum order units
Unités commande minimale

Rollos sin Soldadura
Rolls without Welding - Rouleaux non soudées

L mm	A mm	E mm	8% Co €
100000	20	0,90	1.456,48
100000	27	0,90	1.513,73
134000			2.083,71
100000	34	1,10	1.858,78
75000	41	1,30	1.979,05

Ejemplo Pedido / Order Example / Exemple Commande **Ref. 4229 + L 2080 + A 27 + E 0,90 + TPI 5-8 + TZ K**



Ref. **1994**

ARCO SIERRA
Hacksaw Frame
Monture scie

¡Hoja de Sierra de Regalo!
Free Hacksaw Blade!
Lame scie **cadeau!**



Arco ergonómico de aleación de aluminio. Corte recto, vertical y horizontal. Hoja sierra regalo art. 67592: TPI 24

Ergonomic Aluminium alloyed hack saw frame. Straight cut, both vertical and horizontal. Free hacksaw blade art. 67592: TPI 24

Monture ergonomique de alliage aluminium. Coupe droite et horizontale. Lame scie cadeau art. 67592 : TPI 24



Nº Art.	€
62289	10,56



Ref. **1999**

HOJA SIERRA
Hacksaw Blade
Lame scie

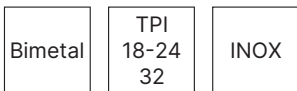

Aceros <850 N/mm² Steel / Aciers
Aceros <1000 N/mm² Steel / Aciers
INOX Stainless Steel Acier INOX

New!

TPI	L mm	Cube	Nº Art.	€ 1 ud.
18	300	20	48809	1,82
18	300	100	13856	1,60
24	300	20	25355	1,82
24	300	100	25387	1,60
32	300	100	28767	1,60



Ref. **1997**

HOJA SIERRA
Hacksaw Blade
Lame scie

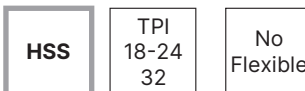

Aceros <850 N/mm² Steel / Aciers
Aceros <1000 N/mm² Steel / Aciers

TPI	L mm	Cube	Nº Art.	€ 1 ud.
18	300	20	48806	1,59
18	300	100	34553	1,35
24	300	20	34552	1,59
24	300	100	34554	1,35
32	300	100	34555	1,35

* Ref. 1997 hasta fin de existencias
while stock lasts / jusqu'à la fin de stock



Ref. **1996**

HOJA SIERRA
Hacksaw Blade
Lame scie



Mod. 1



Mod. 2



Mod.	Usos / Use / Usage	TPI	L mm	Cube	Nº Art.	€ 1 ud.
1	Metal	24	300	50	17139	1,08
2	Metal-Madera/Wood/Bois	24	300	50	67592	0,60



HERRAMIENTAS TORNEADO

Brazed Turning Tools

Outils de tour

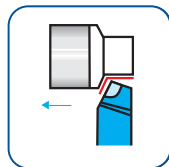
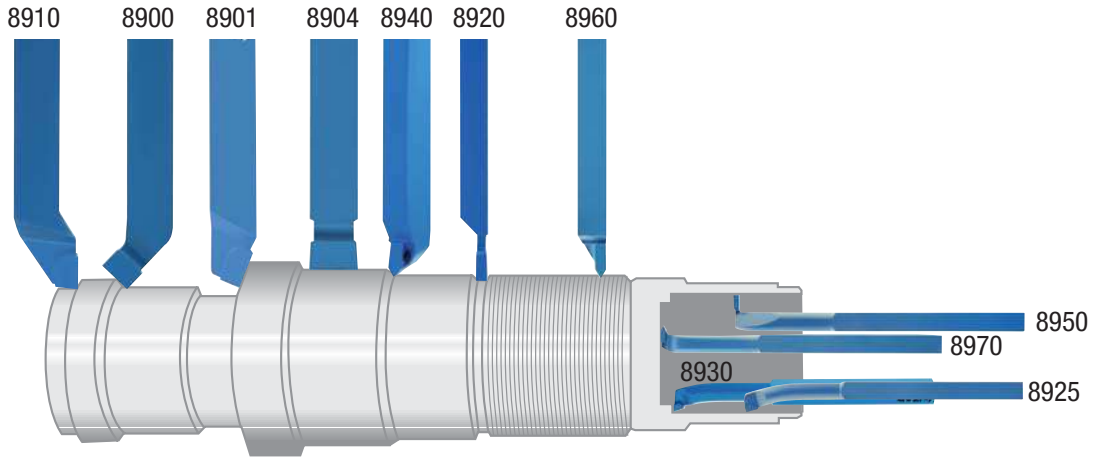

ISO 1 - 8901

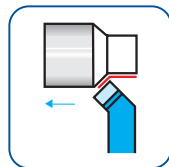

ISO 2 - 8900

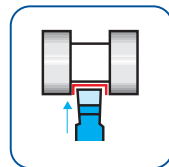

ISO 4 - 8904

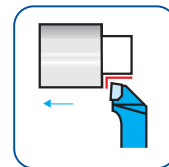

ISO 6 - 8910

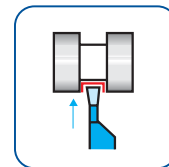

ISO 7 - 8920

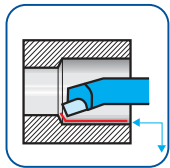

ISO 8 - 8925

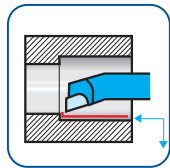

ISO 9 - 8930

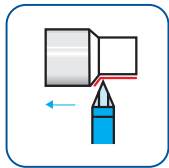

ISO 10 - 8940

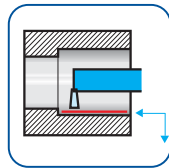

ISO 11 - 8950

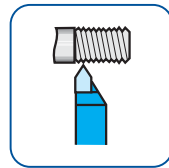

ISO 12 - 8960

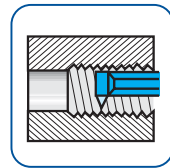

ISO 13 - 8970

Calidad P20

Especialmente destinada a mecanizados de gran precisión y semi-acabado en aceros al carbono y aleados, a grandes velocidades de corte y avances moderados.

P20 Quality

Specially destined for high precision and semi-finishing machining of carbon & alloy steels, at high cutting speeds and moderate feeds.

Qualité P20

Notamment pour usinages haute précision et semi-finition en aciers au carbone et alliés, à hautes vitesses de coupe et avances modérés.

Calidad M20

Especial para acabado y desbaste suave de aceros, aceros al manganeso, fundición y metales resistentes al calor o no ferrosos, a velocidades de corte medias o bajas.

M20 Quality

Special for finishing and soft roughing of steels, manganese-steels, cast iron and heat-resistant or non-ferrous materials, at medium or low cutting speed.

Qualité M20

Spécial finition et ébauche tendre d'aciers, aciers au manganèse, fonte et aciers résistants au chaud et non ferreux à faibles où moyennes vitesses de coupe.

Calidad K10

Especial para mecanizados de gran precisión y semi-acabado en fundición, aceros aleados, materiales de viruta corta y no ferrosos.

K10 Quality

Special for high precision and semi-finishing machining of cast iron, alloyed steels, short chipping and non-ferrous materials.

Qualité K10

Spéciale pour usinage d'haute précision et semi-finition fonte, alliages aciers, aciers copeaux courts et non ferreux.

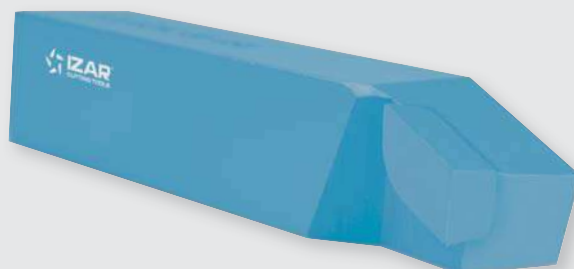

Ref. **8901**

HERRAMIENTA TORNEADO PLACA SOLDADA CILINDRADO 70°

70° Straight Brazed Turning Tool

Outil de tour plaquette soudé cylindrage 70°

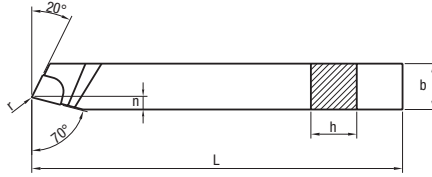

Aceros <850 N/mm ² Steel / Aciers	Aceros <1000 N/mm ² Steel / Aciers	Fundición Cast Iron Fonte
Aceros <1300 N/mm ² Steel / Aciers	INOX Stainless Steel Acier INOX	Cobre Copper Cuivre
Fundición Cast Iron Fonte		Aluminio Aluminium

h mm	b mm	L mm	R/L	n mm	r mm	Calidad Quality / Qualité P-20		Calidad Quality / Qualité K-10	
						N° Art.	€	N° Art.	€
10	10	90	- L	4	0,2	55888	8,16	55889	8,16
10	10	90	- R	4	0,2	55893	8,16	55891	8,16
12	12	100	- L	5	0,4	55894	8,77	55897	8,77
12	12	100	- R	5	0,4	55896	8,77	55899	8,77
16	16	110	- L	6	0,4	55903	11,03	55905	11,03
16	16	110	- R	6	0,4	55904	11,03	55906	11,03
20	20	125	- L	8	0,8	55911	15,06	55913	15,06
20	20	125	- R	8	0,8	55912	15,06	55914	15,06
25	25	140	- L	10	0,8	55917	22,27	55919	22,27
25	25	140	- R	10	0,8	55918	22,27	55920	22,27



Ref. **8900**

HERRAMIENTA TORNEADO PLACA SOLDADA ESCUADRADO 45°

45° Bent Brazed Turning Tool

Outil de tour plaquette soudé décolletage 45°

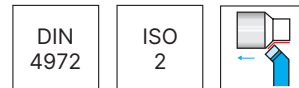
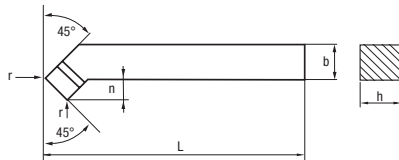
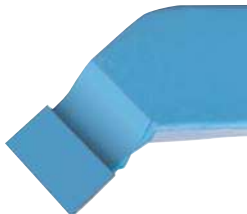

Aceros <850 N/mm ² Steel / Aciers	Aceros <1000 N/mm ² Steel / Aciers	Fundición Cast Iron Fonte
Aceros <1300 N/mm ² Steel / Aciers	INOX Stainless Steel Acier INOX	Cobre Copper Cuivre
Fundición Cast Iron Fonte	INOX Stainless Steel Acier INOX	Aluminio Aluminium

h mm	b mm	L mm	R/L	n mm	r mm	Calidad Quality / Qualité P-20		Calidad Quality / Qualité M-20		Calidad Quality / Qualité K-10	
						N° Art.	€	N° Art.	€	N° Art.	€
12	12	100	- L	7	0,4	13586	9,74	56073	9,74	29179	9,74
12	12	100	- R	7	0,4	13585	9,74	56074	9,74	29153	9,74
16	16	110	- L	8	0,4	13589	12,14	56076	12,14	29181	12,14
16	16	110	- R	8	0,4	13588	12,14	56077	12,14	18258	12,14
20	20	125	- L	10	0,8	13592	15,42	56078	15,42	13051	15,42
20	20	125	- R	10	0,8	13591	15,42	56079	15,42	28343	15,42
25	25	140	- L	12	0,8	13597	21,83	56080	21,83	29182	21,83
25	25	140	- R	12	0,8	13594	21,83	56082	21,83	26003	21,83



Ref. **8904**

HERRAMIENTA TORNEADO PLACA SOLDADA RANURADO EXTERIOR

Wide Face Square Nose Brazed Turning Tool
Outil de tour plaquette soudé rainurage extérieur

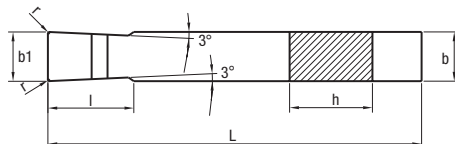

DIN
4976

ISO
4



Aceros <850 N/mm ² Steel / Aciers	Aceros <1000 N/mm ² Steel / Aciers
Aceros <1300 N/mm ² Steel / Aciers	INOX Stainless Steel Acier INOX
Fundición Cast Iron Fonte	

Fundición Cast Iron Fonte
Cobre Copper Cuivre
Aluminio Aluminium

h mm	b mm	L mm	r mm	l mm	b1 mm	Calidad Quality / Qualité P-20		Calidad Quality / Qualité K-10	
						N° Art.	€	N° Art.	€
20	12	125	0,4	20	12	55924	11,86	55926	11,86
25	16	140	0,4	25	16	55928	16,51	55932	16,51
32	20	170	0,4	32	20	55936	24,76	55938	24,76



Ref. **8910**

HERRAMIENTA TORNEADO PLACA SOLDADA ESCUADRADO 90°

90° Offset Side Brazed Turning Tool
Outil de tour plaquette soudé décolletage 90°

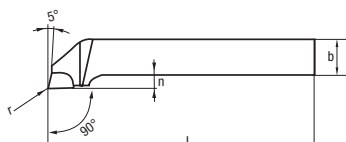

DIN
4980

ISO
6



Aceros <850 N/mm ² Steel / Aciers	Aceros <1000 N/mm ² Steel / Aciers
Aceros <1300 N/mm ² Steel / Aciers	INOX Stainless Steel Acier INOX
Fundición Cast Iron Fonte	

INOX
Stainless Steel
Acier INOX

Fundición Cast Iron Fonte
Cobre Copper Cuivre
Aluminio Aluminium

h mm	b mm	L mm	R/L	n mm	r mm	Calidad Quality / Qualité P-20		Calidad Quality / Qualité M-20		Calidad Quality / Qualité K-10	
						N° Art.	€	N° Art.	€	N° Art.	€
10	10	090	- L	4	0,2	13601	8,82	56083	8,82	29183	8,82
10	10	090	- R	4	0,2	13600	8,82	56085	8,82	26488	8,82
12	12	100	- L	5	0,4	13604	9,79	56086	9,79	29185	9,79
12	12	100	- R	5	0,4	13603	9,79	56088	9,79	26707	9,79
16	16	110	- L	6	0,4	13607	11,87	56089	11,87	13058	11,87
16	16	110	- R	6	0,4	13606	11,87	56091	11,87	27460	11,87
20	20	125	- L	8	0,8	13612	15,80	56092	15,80	10825	15,80
20	20	125	- R	8	0,8	13609	15,80	56093	15,80	27461	15,80
25	25	140	- L	10	0,8	13616	23,00	56094	23,00	17090	23,00
25	25	140	- R	10	0,8	13615	23,00	56095	23,00	11181	23,00



Ref. **8920**

HERRAMIENTA TORNEADO PLACA SOLDADA TRONZADO

Parting Brazed Turning Tool
Outil de tour plaquette soudé tronçonnage

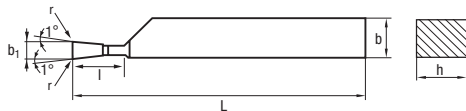

DIN
4981

ISO
7



Aceros <850 N/mm ² Steel / Aciers	Aceros <1000 N/mm ² Steel / Aciers
Aceros <1300 N/mm ² Steel / Aciers	INOX Stainless Steel Acier INOX
Fundición Cast Iron Fonte	

INOX
Stainless Steel
Acier INOX

Fundición
Cast Iron
Fonte

Cobre
Copper
Cuivre

Aluminio
Aluminium



h mm	b mm	L mm	R/L	r mm	l mm	b1 mm	Calidad Quality / Qualité P-20		Calidad Quality / Qualité M-20		Calidad Quality / Qualité K-10	
							N° Art.	€	N° Art.	€	N° Art.	€
12	8	100	- L	0,2	12	3	13619	9,15			28344	9,15
12	8	100	- R	0,2	12	3	13618	9,15	56098	9,15	27519	9,15
16	10	110	- L	0,2	14	4	13622	9,98			29186	9,98
16	10	110	- R	0,2	14	4	13621	9,98	56100	9,98	19523	9,98
20	12	125	- L	0,2	16	5	13625	11,54			29187	11,54
20	12	125	- R	0,2	16	5	13624	11,54	56102	11,54	22685	11,54
25	16	140	- L	0,3	20	6	13628	15,30			29189	15,30
25	16	140	- R	0,3	20	6	13627	15,30	56104	15,30	29188	15,30

Ref. **8925**

HERRAMIENTA TORNEADO PLACA SOLDADA MANDRINADO

Boring Straight Brazed Turning Tool
Outil de tour plaquette soudé alésage

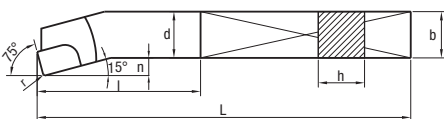

DIN
4973

ISO
8

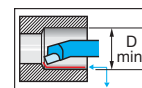

Aceros <850 N/mm ² Steel / Aciers	Aceros <1000 N/mm ² Steel / Aciers
Aceros <1300 N/mm ² Steel / Aciers	INOX Stainless Steel Acier INOX
Fundición Cast Iron Fonte	

Fundición
Cast Iron
Fonte

Cobre
Copper
Cuivre

Aluminio
Aluminium

h mm	b mm	L mm	n mm	r mm	D min. mm	Calidad Quality / Qualité P-20		Calidad Quality / Qualité K-10	
						N° Art.	€	N° Art.	€
8	8	125	3	0,4	14	38218	11,67	38220	11,67
10	10	150	4	0,4	18	38222	12,02	38224	12,02
12	12	180	5	0,4	21	38227	12,36	38391	12,36
16	16	210	6	0,4	27	38393	13,87	38395	13,87
20	20	250	8	0,4	34	38397	18,03	38399	18,03
25	25	300	10	0,8	43	38401	28,38	38403	28,38



Ref. **8930**

HERRAMIENTA TORNEADO PLACA SOLDADA CILINDRADO INTERIOR

Internal Sharped Brazed Turning Tool

Outil de tour plaquette soudé cylindrage intérieur

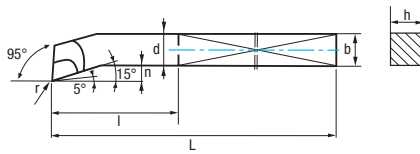

DIN
4974

ISO
9

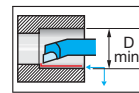

Aceros <850 N/mm ² Steel / Aciers	Aceros <1000 N/mm ² Steel / Aciers
Aceros <1300 N/mm ² Steel / Aciers	INOX Stainless Steel Acier INOX
Fundición Cast Iron Fonte	

INOX
Stainless Steel
Acier INOX

Fundición
Cast Iron
Fonte

Cobre
Copper
Cuivre

Aluminio
Aluminium

h mm	b mm	L mm	d mm	n mm	r mm	l mm	D min. mm	Calidad Quality / Qualité P-20		Calidad Quality / Qualité M-20		Calidad Quality / Qualité K-10	
								N° Art.	€	N° Art.	€	N° Art.	€
8	x 8	x 125	8	3	0,2	40	14	13630	12,02	56114	12,02	14971	12,02
10	x 10	x 150	10	4	0,2	50	18	13631	11,87	56115	11,87	27462	11,87
12	x 12	x 180	12	5	0,2	63	21	13633	12,59	56116	12,59	27464	12,59
16	x 16	x 210	16	6	0,2	80	27	13634	15,00	56117	15,00	11152	15,00
20	x 20	x 250	20	8	0,4	100	34	13636	18,96	56118	18,96	11754	18,96
25	x 25	x 300	25	10	0,4	125	43	13639	28,80	56119	28,80	27518	28,80
32	x 32	x 355	32	12	0,8	160	52	13642	50,69	56121	50,69	13896	50,69

Ref. **8940**

HERRAMIENTA TORNEADO PLACA SOLDADA CILINDRADO RECTO

Sharped Straight Brazed Turning Tool

Outil de tour plaquette soudé cylindrage droit

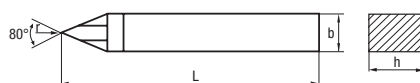

DIN
4975

ISO
10



Aceros <850 N/mm ² Steel / Aciers	Aceros <1000 N/mm ² Steel / Aciers
Aceros <1300 N/mm ² Steel / Aciers	INOX Stainless Steel Acier INOX
Fundición Cast Iron Fonte	

Fundición
Cast Iron
Fonte

Cobre
Copper
Cuivre

Aluminio
Aluminium

h mm	b mm	L mm	r mm	Calidad Quality / Qualité P-20		Calidad Quality / Qualité K-10	
				N° Art.	€	N° Art.	€
16	x 10	x 110	0,2	13645	8,97	29190	8,97
20	x 12	x 125	0,4	13646	10,39	29191	10,39
25	x 16	x 140	0,4	13648	13,27	29192	13,27



Ref. **8950**

HERRAMIENTA TORNEADO PLACA SOLDADA RANURADO INTERIOR

Internal Undercutting Brazed Turning Tool

Outil de tour plaquette soudé rainurage intérieur

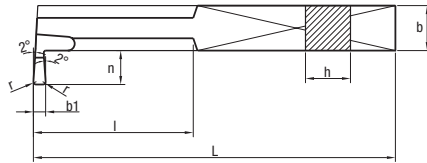

DIN
263

ISO
11

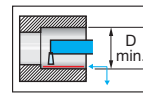

Aceros <850 N/mm ² Steel / Aciers	Aceros <1000 N/mm ² Steel / Aciers	Fundición Cast Iron Fonte
Aceros <1300 N/mm ² Steel / Aciers	INOX Stainless Steel Acier INOX	Cobre Copper Cuivre
Fundición Cast Iron Fonte		Aluminio Aluminium

h mm	b mm	L mm	n mm	r mm	b1 mm	D min. mm	Calidad Quality / Qualité P-20		Calidad Quality / Qualité K-10	
							N° Art.	€	N° Art.	€
12	12	180	10	0,2	4	32	38405	19,62	38407	19,62
16	16	210	12	0,2	5	40	38409	24,52	38411	24,52
20	20	250	16	0,4	6	50	38413	30,96	38415	30,96
25	25	300	20	0,4	8	63	38417	38,91	38419	38,91



Ref. **8960**

HERRAMIENTA TORNEADO PLACA SOLDADA ROSCADO EXTERIOR

External Threading Brazed Turning Tool

Outil de tour plaquette soudé taraudage extérieur



DIN
282

ISO
12



Aceros <850 N/mm ² Steel / Aciers	Aceros <1000 N/mm ² Steel / Aciers	Fundición Cast Iron Fonte
Aceros <1300 N/mm ² Steel / Aciers	INOX Stainless Steel Acier INOX	Cobre Copper Cuivre
Fundición Cast Iron Fonte		Aluminio Aluminium

h mm	b mm	L mm	R/L	n mm	Calidad Quality / Qualité P-20		Calidad Quality / Qualité K-10	
					N° Art.	€	N° Art.	€
16	10	110	- L	2,0	38422	10,90	38424	10,90
16	10	110	- R	2,0	38421	10,90	38423	10,90
20	12	125	- L	2,5	38426	12,77	38428	12,77
20	12	125	- R	2,5	38425	12,77	38427	12,77
25	16	140	- L	3,0	38430	16,62	38432	16,62
25	16	140	- R	3,0	38429	16,62	38431	16,62



Ref. **8970**

HERRAMIENTA TORNEADO PLACA SOLDADA ROSCADO INTERIOR

Internal Threading Brazed Turning Tool

Outil de tour plaquette soudé taraudage intérieur

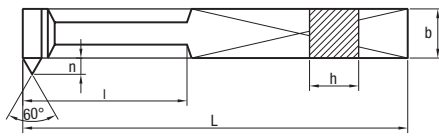

DIN
283

ISO
13

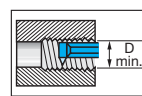

Aceros <850 N/mm ² Steel / Aciers	Aceros <1000 N/mm ² Steel / Aciers	Fundición Cast Iron Fonte
Aceros <1300 N/mm ² Steel / Aciers	INOX Stainless Steel Acier INOX	Cobre Copper Cuivre
Fundición Cast Iron Fonte		Aluminio Aluminium



h mm	b mm	L mm	R/L	n mm	D min. mm	Calidad Quality / Qualité P-20		Calidad Quality / Qualité K-10	
						N° Art.	€	N° Art.	€
10	x 10	x 150	- L	5	22	38434	18,70	38436	18,70
10	x 10	x 150	- R	5	22	38433	18,70	38435	18,70
12	x 12	x 180	- L	6	24	38438	19,04	38440	19,04
12	x 12	x 180	- R	6	24	38437	19,04	38439	19,04
16	x 16	x 210	- L	8	32	38442	25,03	38444	25,03
16	x 16	x 210	- R	8	32	38441	25,03	38443	25,03
20	x 20	x 250	- L	10	40	38446	29,71	38448	29,71
20	x 20	x 250	- R	10	40	38445	29,71	38447	29,71
25	x 25	x 300	- L	12	49	38450	42,14	38452	42,14
25	x 25	x 300	- R	12	49	38449	42,14	38451	42,14

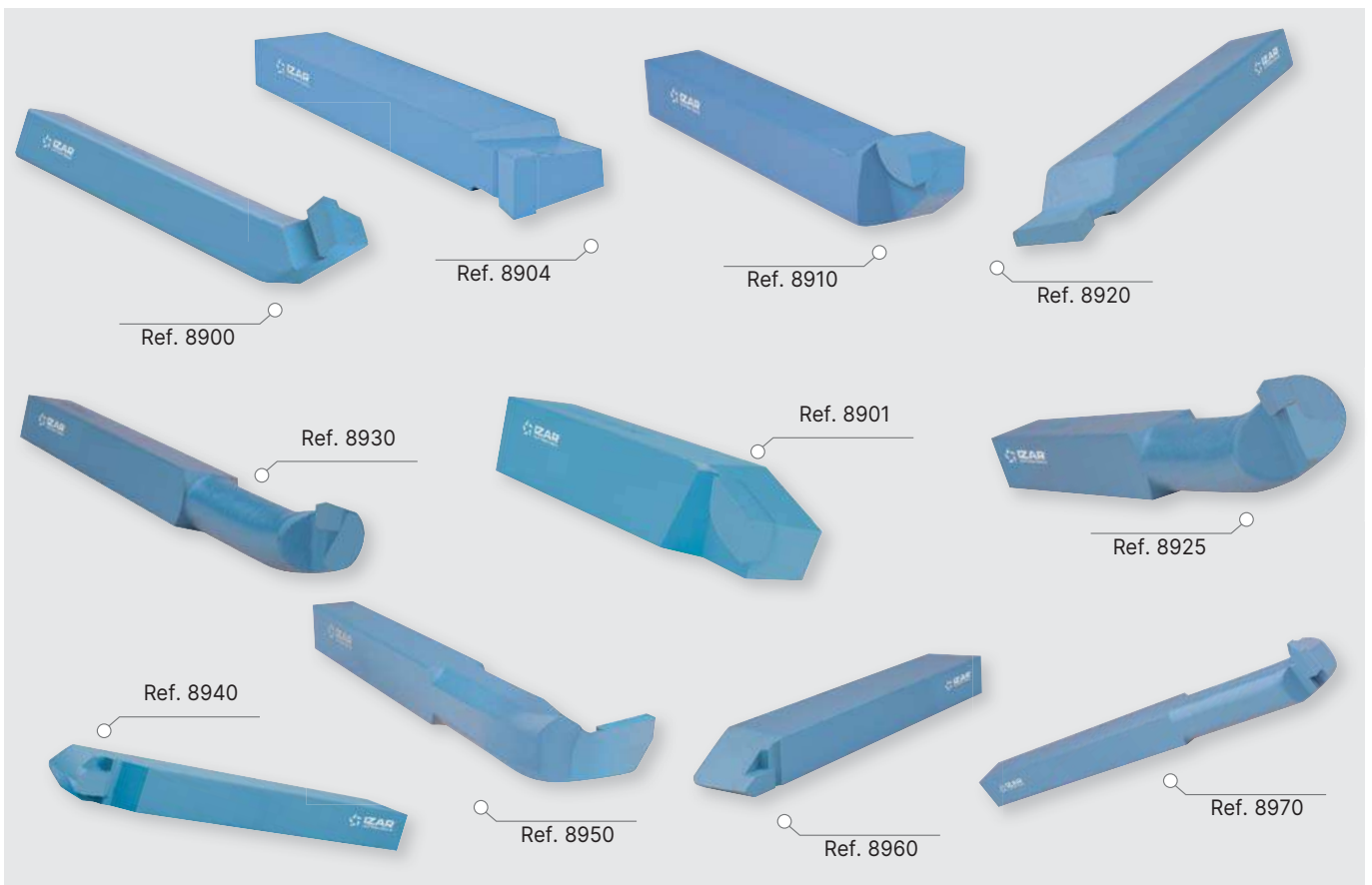

Ref. **8990**

CUCHILLA CUADRADA TORNEADO

Square Turning Blade
Outil de tour carré

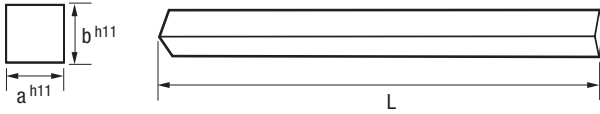

Cuchillas Torno
Turning Tools
Outils de tour

HSSE
10% Co

DIN
4964B



a mm	b mm	L mm	Nº Art.	€
6	x 6	x 100	35462	11,65
6	x 6	x 160	35463	17,39
6	x 6	x 200	35464	21,60
8	x 8	x 100	35465	19,58
8	x 8	x 160	35466	26,98
8	x 8	x 200	35467	32,19
10	x 10	x 100	35468	27,96
10	x 10	x 160	35469	41,56
10	x 10	x 200	35470	53,30
12	x 12	x 100	35471	34,14
12	x 12	x 160	35472	47,80
12	x 12	x 200	35473	62,13
14	x 14	x 200	35474	73,75
16	x 16	x 200	35475	91,82
18	x 18	x 200	35476	133,40
20	x 20	x 200	35477	171,95
25	x 25	x 200	35478	269,41



Ref. **8991**

CUCHILLA REDONDA TORNEADO

Round Turning Blade
Outil de tour rond

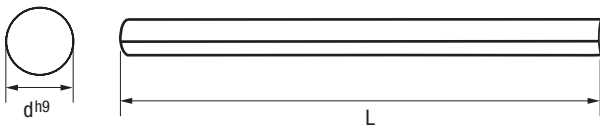

Cuchillas Torno
Turning Tools
Outils de tour

HSSE
10% Co

DIN
4964A



d mm	L mm	Nº Art.	€
4	x 100	35479	9,91
5	x 100	35480	11,37
5	x 200	35481	22,80
6	x 100	35482	12,85
6	x 160	35484	19,31
6	x 200	35483	23,48
8	x 100	35485	16,81
8	x 160	35486	26,47
8	x 200	35487	31,46
10	x 100	35488	24,90
10	x 160	35489	44,19
10	x 200	35490	54,63
12	x 100	35491	27,22
12	x 200	35492	70,66
14	x 200	35493	98,51
16	x 200	35494	103,70
18	x 200	35495	179,99
20	x 200	35497	181,31



Ref. **8992**

CUCHILLA TRAPEZOIDAL TORNEADO

Trapezoidal Turning Blade
Outil de tour trapézoïdal



HSSE
10% Co

DIN
4964E

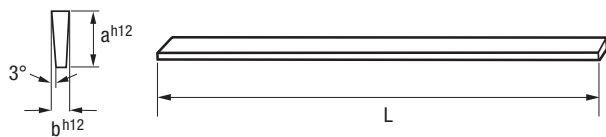

a mm	b mm	L mm	N° Art.	€
10	2,50	100	13690	19,47
12	3,00	100	13691	21,53
12	3,00	160	13693	30,80
16	4,00	100	13782	31,23
16	4,00	160	13786	63,40
20	5,00	160	13787	78,29
20	5,00	200	14213	108,14
25	6,00	160	14225	105,51

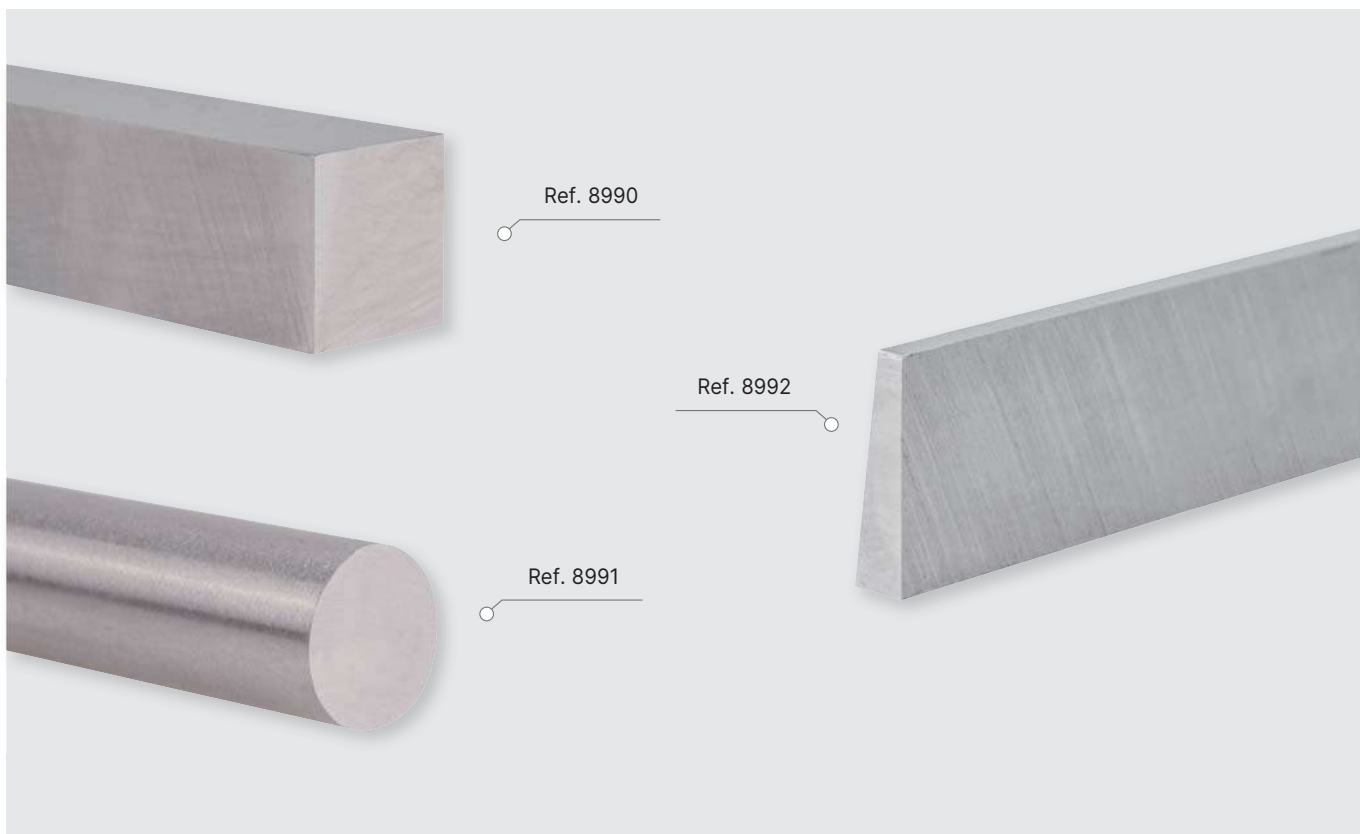

Ref. **8301**

GRANETE
Centre Punch
Pointeau à marquer



Ref. 8301
Hasta fin de existencias
While stock lasts
Jusqu'à la fin de stock

D mm	d mm	L mm		Nº Art.	€ 1 ud.
2	9	130	10	13302	4,05
4	9	130	10	13304	4,05
5	11	150	10	13305	7,31
8	11	160	10	13307	7,31



Ref. **8302**

BOTADOR CÓNICO
Taper Punch
Poinçon conique



Ref. 8302
Hasta fin de existencias
While stock lasts
Jusqu'à la fin de stock

D mm	d mm	L mm		Nº Art.	€ 1 ud.
2	9	130	10	13308	5,38
4	9	130	10	13309	5,38
5	9	130	10	13310	5,38
6	11	160	10	13311	6,74
8	11	160	10	13312	6,78
10	11	160	10	13313	6,95



Ref. **8303**

BOTADOR CILÍNDRICO
Parallel Punch
Poinçon cylindrique



Ref. 8303
Hasta fin de existencias
While stock lasts
Jusqu'à la fin de stock

D mm	d mm	L mm		Nº Art.	€ 1 ud.
2	9	160	10	13314	3,93
3	9	160	10	13315	3,99
5	11	160	10	13316	4,91
6	11	160	10	13318	4,93
7	11	160	10	13324	4,93
9	11	160	10	13916	5,02
10	11	160	10	13917	5,02



Ref. **8304**

CINCEL Y BURIL
Cold & Cape Chisel
Ciseau et burin



Ref. 8304
Hasta fin de existencias
While stock lasts
Jusqu'à la fin de stock

Tipo Type Type	D mm	d mm	L mm		Nº Art.	€ 1 ud.
Cinzel Cold Chisel Ciseau	12	9,5	13	10	13918	7,65
Buril Cape Chisel Burin	5	9,5	13	10	13920	9,08



Ref. **8310**

SETS GRANETES, BOTADORES, CINCELES Y BURILES

Punches and Chisels Sets

Sets pointeaux, poinçons, ciseaux et burins

Ref. 8310

Hasta fin de existencias / while stock lasts / jusqu'à la fin de stock



Mod. 1

6 Pcs



Cont. Ref.	Cont. Descrip.	Nº Art.	€
8304 8302 8301	Buril, Cíncel, Cónicos 2-4, Granetes 4-6 Cold & Cape Chisel, Taper 2-4 & Centre Punch. 4-6 Burin, Ciseau, Coniques 2-4, Pointeaux 4-6	13921	44,08

Mod. 2

6 Pcs



Cont. Ref.	Cont. Descrip.	Nº Art.	€
8304 8302 8301 8303	Buril, Cíncel, Cónico 4, Granete 4, Cilíndricos 4-8 Cold & Cape Chisel, Taper 4, Centre 4 & Parallel 4-8 Burin, Ciseau, Conique 4, Pointeau 4, Cylíndriques 4-8	13923	43,87

Mod. 3

6 Pcs



Cont. Ref.	Cont. Descrip.	Nº Art.	€
8304 8301	Buril, Cíncel, Granetes 2-4-6-8 Cold & Cape Chisel, Centre Punches 2-4-6-8 Burin, Ciseau, Pointeaux 2-4-6-8	13924	46,39

Mod. 4

6 Pcs



Cont. Ref.	Cont. Descrip.	Nº Art.	€
8302	Cónicos 2-4-5-6-8-10 Taper Punches 2-4-5-6-8-10 Coniques 2-4-5-6-8-10	13926	40,65

Mod. 6

6 Pcs



Cont. Ref.	Cont. Descrip.	Nº Art.	€
8303	Cilíndricos 5-6-7-8-9-10 Parallel Punches 5-6-7-8-9-10 Cylíndriques 5-6-7-8-9-10	13928	44,16



Ref. **8352**

REBARBADOR EXTERIOR

External Chamfer Tool
Outil de chanfrein externe

New!

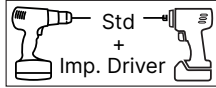
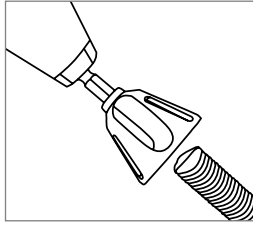

Aceros
<850 N/mm²
Steel / Aciers

Fundición
Cast Iron
Fonte

Cobre
Copper
Cuivre

Latón
Brass
Laiton

Aluminio
Aluminium

Cap.	Nº Art.	€
Ø 6 - 25 mm	25381	16,70



Video

Ref. **8351**

ACCESORIOS REBARBADORES

Deburring Tool Accessories
Accessoires ébavureurs



Mango / Shank / Queue

Medida Size - Dimension		Nº Art.	€
00001	1	12834	11,44



Porta **Universal** Holder

Medida Size - Dimension		Nº Art.	€
00006UNI	1	76576	9,29



Cuchillas Blades Lames	Material Materiel		Nº Art.	€ pack
B10	HSS	10	12825	16,43
B20	HSS	10	12827	16,43



Cuchillas Blades Lames	Material Materiel		Nº Art.	€ pack
E100	HSS	10	12829	19,50
E100S	HSSE	10	12830	21,31
E200	HSS	10	12831	19,50
E300	HSS	10	12833	22,45



Ref. **8350**

JUEGO REBARBADORES

Deburring Tool Sets
Jeux ébavureurs



MOD. B



Juego
Mod. B
Set



Aceros
<850 N/mm²
Steel / Aciers

Fundición
Cast Iron
Fonte

Cobre
Copper
Cuivre

Latón
Brass
Laiton

Aluminio
Aluminium

Plásticos
Plastics
Plastiques



B10

+



B20

4 Pcs

Cont.	Nº Art.	€
Mango / Shank / Queue Porta Universal Holder B10 / B20	12816	23,64

MOD. E



Juego
Mod. E
Set



Aceros
<850 N/mm²
Steel / Aciers

Fundición
Cast Iron
Fonte

Cobre
Copper
Cuivre

Latón
Brass
Laiton

Aluminio
Aluminium

Plásticos
Plastics
Plastiques



E100

+



E200



E300

5 Pcs

Cont.	Nº Art.	€
Mango / Shank / Queue Porta Universal Holder E100 / E200 / E300	12805	26,69



Ref. **8325**

CORTA TUBOS 25 mm

25 mm Pipe Cutters
Coupe tubes 25 mm

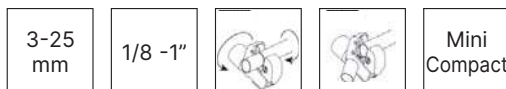

INOX
Stainless Steel
Acier INOX

Cobre
Copper
Cuivre

Aluminio
Aluminium

Mod.	Min. mm	Max. mm	Pulgadas Inches Pouces	Nº Art.	€
25	3	25	1/8 - 1"	34244	14,11

Ref. **8330**

CORTA TUBOS 30 mm

30 mm Pipe Cutters
Coupe tubes 30 mm

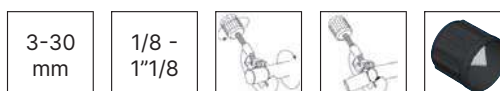

INOX
Stainless Steel
Acier INOX

Cobre
Copper
Cuivre

Aluminio
Aluminium

Mod.	Min. mm	Max. mm	Pulgadas Inches Pouces	Nº Art.	€
30	3	30	1/8 - 1 1/8"	34245	14,62



Ref. **8335**

CORTA TUBOS 35 mm

35 mm Pipe Cutters
Coupe tubes 35 mm



Cambio Rápido Cuchilla
Quick Cutting Wheel Change
Changement rapide molette

Rebarbador incluido
Deburring Tool included
Ébavureur compris

INOX
Stainless Steel
Acier INOX

Cobre
Copper
Cuivre

Aluminio
Aluminium

Mod.	Min. mm	Max. mm	Pulgadas Inches Pouces	Nº Art.	€
35	3	35	1/8 - 1 3/8"	34246	35,85



Ref. **8341**

CUCHILLAS REPUESTO

Spare Wheels
Lames de rechange

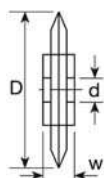

Mod.	D mm	d mm	w mm	Nº Art.	€
1	20	5	5	34247	2,78



Ref. **8326**

CORTA TUBOS TIJERA PLÁSTICO Y MULTICAPA

Plastic & Multilayer Pipe Scissors

Coupe tubes ciseaux pour plastique et multicouche



26 mm
(1")

INOX+Teflon®
Stainless+Teflon®
INOX+Téflon®

Cuerpo Mg
Mg Body
Corps Mg

PE, PP, PB, PEX, MLP/MSR,
VPE, CPVC, PVC, PVDF, PPR

Mod.	Max. mm	Pulgadas Inches Pouces	Nº Art.	€
26	26	1"	36633	31,31



1- Cuchilla INOX + Teflon®: Menor adherencia entre tubo y cuchilla

2- Zona de apoyo mejorada: Tubo mejor asentado, corte más preciso

3- Cambio cuchilla instantáneo: Sin necesidad de herramientas

1- Stainless + Teflon® blade: Lower adhesion between pipe & blade

2- Improved base area: Better leaned pipe, accurate cutting

3- Instant blade change: No tools needed

1- Lame INOX + Téflon®: Moindre adhérence entre tuyau et lame

2- Zone d'appui améliorée: Tuyau mieux fixé, coupe plus précis

3- Changement de lame immédiat: Sans besoin d'outils

Ref. **8321**

CUCHILLAS REPUESTO - Spare Blades - Lames de rechange

INOX+Teflon®
Stainless+Teflon®
INOX+Téflon®



Hoja
Blade
Lame
mm



Nº
Art.

€

26 1 37423 11,81



Ref. **8342**

CORTA TUBOS TIJERA PLÁSTICO Y MULTICAPA

Plastic & Multilayer Pipe Scissors

Coupe tubes ciseaux pour plastique et multicouche



42 mm
(1 5/8")

INOX+Teflon®
Stainless+Teflon®
INOX+Téflon®

Cuerpo Mg
Mg Body
Corps Mg

PE, PP, PB, PEX, MLP/MSR,
VPE, CPVC, PVC, PVDF, PPR

Mod.	Max. mm	Pulgadas Inches Pouces	Nº Art.	€
42	42	1"5/8	36635	54,36



- 1- Cuchilla INOX + Teflon®: Menor adherencia entre tubo y cuchilla
- 2- Zona de apoyo mejorada: Tubo mejor asentado, corte más preciso
- 3- Cambio cuchilla instantaneo: Sin necesidad de herramientas
- 4- Cuchilla recogida en el cuerpo

- 1- Stainless + Teflon® blade: Lower adhesion between pipe & blade
- 2- Improved base area: Better leaned pipe, accurate cutting
- 3- Instant blade change: No tools needed
- 4- Blade positioned within the body

- 1- Lame INOX + Téflon®: Moindre adhérence entre tuyau et lame
- 2- Zone d'appui améliorée: Tuyau mieux fixé, coupe plus précis
- 3- Changement de lame immédiat: Sans besoin d'outils
- 4- Lame dans le corps de l'outil

Ref. **8321**

CUCHILLAS REPUESTO - Spare Blades - Lames de rechange

INOX+Teflon®
Stainless+Teflon®
INOX+Téflon®



Hoja
Blade
Lame
mm



Nº
Art.

€

42 1 37424 21,90



Ref. **8345****RECOGEVIRUTAS MAGNÉTICO**Magnetic Retrieving Baton
Aimant à copeaux

D mm	L mm	Nº Art.	€
25,40	400	69499	57,54



Imán especialmente diseñado para recoger viruta ferrosa en lugares difícilmente accesibles. Ideal para cubos de almacenaje, limpieza de agua o desengrasado de tanques, muros y esquinas... Práctico extensor que deja caer el material recogido a la vez que protege la mano de la viruta.

Specially designed Magnet to retrieve ferrous metal materials from hard to reach locations. Ideal for storage bins, water cleaning or tank degreasing, walls and corners... Practical extension for an easy releasing the collected material. It protects the hand from the chips.

Aimant spécialement dessiné pour ramasser les copeaux de fer dans des zones de difficile accès. Conseillés pour nettoyage d'eau, murs, corners. Pratique extenseur qui permet que le matériel tombe une fois ramassé et protège les mains des copeaux.



CONSTRUCCIÓN

Construction

Construction



HERRAMIENTAS SDS PLUS

SDS plus Tools
Outils SDS plus

238



HERRAMIENTAS SDS MAX

SDS max Tools
Outils SDS max

248



ADAPTADOR iCONNECT

iConnect Adaptor
Adaptateur iConnect

252



CINCELES

Chisels
Burins

254



BROCAS MANGO CILÍNDRICO

Straight Shank Drill Bits
Forets queue cylindrique

259



CORONAS

Hole Saws
Tréfans

277

DISCOS DIAMANTE

Diamond Cutting Blades
Disques diamant

287



HERRAMIENTAS SDS PLUS

SDS plus Tools

Outils SDS plus

Ref. **1891**

BROCA-MARTILLO SDS PLUS 4Z+

4Z+ Cutter SDS plus Rotary Hammer Drill Bit

Foret percussion SDS plus 4Z+

Zentro 4+



Zentro
4+
<10mm

Zentro
4
10-16 mm

SDS
plus



Video

Hormigón Reforzado
Reinforced Concrete
Béton armé

Hormigón
Concrete
Béton

Hormigón Bloque
Concrete Block
Parpaing

Piedra Natural
Natural Stone
Pierre naturelle



Punta centradora MD soldada al cuerpo

Solid carbide centering tip welded to the body

Pointe autocentrante carbure soudée au corps



Hombros reforzados

⇒ Mejor rotura del material.
Marca desgaste

Reinforced shoulders

⇒ Better material breaking.
Wear Marking

Épaules de la pointe reforçadas

⇒ Meilleure rupture du matériel.
Marque l'usure.

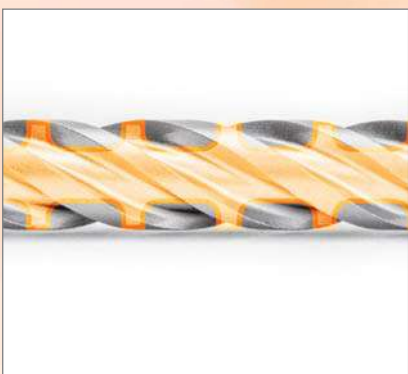

Diseño nucleo reforzado exclusivo

⇒ Mejor rendimiento y vida más larga

Exclusive reinforced core design

⇒ Better performance & longer life

Dessin noyau renforcé et exclusif



⇒ Meilleure performance et vie de l'outil plus longue



Ref. **1891**

BROCA-MARTILLO SDS PLUS 4Z+

4Z+ Cutter SDS plus Rotary Hammer Drill Bit
Foret percussion SDS plus 4Z+

D mm	L mm	I mm		Nº Art.	€	D mm	L mm	I mm		Nº Art.	€	D mm	L mm	I mm		Nº Art.	€
5,00	115	50	1	32043	5,09	10,00	115	50	1	32058	7,43	14,00	450	400	1	36692	27,48
5,00	165	100	1	32044	5,69	10,00	165	100	1	32059	7,94	14,00	600	550	1	36693	38,36
5,00	215	150	1	55961	8,34	10,00	215	150	1	32060	9,48	14,00	1000	950	1	36694	85,82
5,00	265	200	1	66376	10,40	10,00	265	200	1	32061	12,20	15,00	160	110	1	60059	17,62
5,00	315	250	1	69437	13,35	10,00	315	250	1	32062	15,52	15,00	260	210	1	60061	22,87
5,50	115	50	1	32041	6,76	10,00	455	400	1	32063	21,28	15,00	450	400	1	60062	29,69
5,50	165	100	1	32042	7,07	10,00	600	550	1	36688	27,13	16,00	160	110	1	36695	21,80
6,00	115	50	1	32045	4,98	10,00	1000	950	1	36689	63,64	16,00	210	160	1	36696	24,52
6,00	165	100	1	32046	5,46	11,00	160	110	1	69899	10,37	16,00	260	210	1	36863	28,36
6,00	215	150	1	32047	7,35	11,00	210	160	1	69902	12,49	16,00	310	260	1	36699	29,63
6,00	265	200	1	32048	8,82	11,00	260	210	1	69904	14,70	16,00	450	400	1	37455	37,13
6,00	315	250	1	32049	12,92	11,00	310	260	1	81562	19,57	16,00	600	550	1	22113	50,10
6,50	165	100	1	32050	7,08	12,00	160	110	1	32064	9,86	16,00	1000	950	1	36698	101,73
6,50	215	150	1	32074	9,59	12,00	210	160	1	32065	11,77	18,00	250	200	1	16919	37,98
6,50	265	200	1	32072	12,78	12,00	260	210	1	32066	14,26	18,00	450	400	1	16920	44,63
6,50	315	250	1	32073	15,55	12,00	310	260	1	32067	18,53	20,00	250	200	1	16921	42,89
7,00	115	50	1	32052	6,72	12,00	450	400	1	32068	23,16	20,00	450	400	1	16922	51,15
7,00	165	100	1	32053	7,12	12,00	600	550	1	36690	27,86	22,00	250	200	1	39687	51,75
7,00	215	150	1	68615	9,82	12,00	1000	950	1	36697	63,97	22,00	450	400	1	16925	61,60
8,00	115	50	1	32054	6,54	13,00	160	110	1	69905	11,49	24,00	250	200	1	39688	58,09
8,00	165	100	1	32055	6,54	13,00	210	160	1	69907	19,20	24,00	450	400	1	16927	65,20
8,00	215	150	1	32056	8,20	13,00	260	210	1	69908	21,77	25,00	250	200	1	39689	59,67
8,00	265	200	1	32057	9,00	13,00	310	260	1	81563	23,32	25,00	450	400	1	16928	66,11
8,00	315	250	1	36686	11,49	14,00	160	110	1	32069	11,40	28,00	250	200	1	11523	68,95
8,00	465	400	1	36687	19,01	14,00	210	160	1	32070	15,30	28,00	450	400	1	11524	75,99
New! 8,00	605	540	1	85112	24,24	14,00	260	210	1	32071	17,11	30,00	250	200	1	39690	88,18
9,00	165	100	1	56808	8,76	14,00	310	260	1	36691	21,93	30,00	450	400	1	11525	96,23
												32,00	450	400	1	11526	107,44



Línea 1 m - Ref. 1891



∅	5	6	7	8	10	5	6	7	8	10	12	14	6	8	10	12	14	8	16
	L115	L115	L115	L115	L115	L165	L165	L165	L165	L165	L160	L160	L215	L215	L215	L210	L210	L265	L260
Pcs	2	2	2	2	2	2	2	2	2	2	2	2	2	2	2	2	2	2	2

Ref. 4995 - Nº Art. 71015: 348,46 €



Display 67 - Ref. 1891 -1-



∅	24 L250	6 L315	8 L315	10 L315	12 L310	14 L310	16 L310	8 L465
Pcs	1	2	2	1	1	1	1	1
∅	5 L215	6 L215	8 L215	10 L215	12 L210	14 L210	16 L210	6 L265
Pcs	3	3	3	2	2	2	2	2
∅	5 L115	6 L115	7 L115	8 L115	10 L115	5 L165	6 L165	6 L165
Pcs	4	4	4	4	3	4	3	3

Ref. 4995 - N° Art. 75389: 594,11 €

Display 68 - Ref. 1891 -2-



∅	10 L455	12 L450	14 L450	16 L450	18 L450	20 L450	22 L450	24 L450
Pcs	1	1	1	1	1	1	1	1
∅	8 L265	10 L265	12 L260	14 L260	16 L260	18 L250	20 L250	22 L250
Pcs	2	2	1	1	1	1	1	1
∅	7 L165	8 L165	9 L165	10 L165	12 L160	14 L160	15 L160	16 L160
Pcs	2	2	2	2	1	1	1	1

Ref. 4995 - N° Art. 75391: 687,78 €

Display 61 - Ref. 1891 -Básico-Basic-Essentiel-



∅	14 L210	6 L265	8 L265	10 L265	12 L260	6 L315	10 L315	12 L310
Pcs	2	2	2	2	2	2	2	2
∅	8 L165	10 L165	12 L160	14 L160	6 L215	8 L215	10 L215	12 L210
Pcs	2	2	2	2	2	2	2	2
∅	5 L115	6 L115	7 L115	8 L115	10 L115	5 L165	6 L165	7 L165
Pcs	2	2	2	2	2	2	2	2

Ref. 4995 - N° Art. 29487: 456,24 €

Display 31 - Ref. 1891

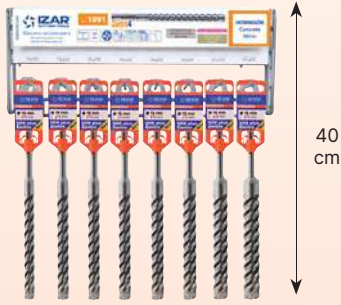

∅	16	18	20	22	24	25	28	30
	L260	L250	L250	L250	L250	L250	L250	L250
Pcs	1	1	1	1	1	1	1	1

Ref. 4995 - N° Art. 22615: 435,87 €

Display 32 - Ref. 1891



∅	16	18	20	22	24	25	28	30
	L450	L450	L450	L450	L450	L450	L450	L450
Pcs	1	1	1	1	1	1	1	1

Ref. 4995 - N° Art. 22617: 498,04 €



Ref. 1869

BROCA-MARTILLO SDS PLUS 4Z+

4Z+ Cutter SDS plus Rotary Hammer Drill Bit
Foret percussion SDS plus 4Z+



D mm	L mm	I mm		N° Art.	€ 1 ud.
5	115	50	10	56503	4,82
5	165	100	10	56506	5,41
6	115	50	10	56507	4,74
6	165	100	10	56509	5,18
6	215	150	10	56510	6,99
8	115	50	10	56967	6,21
8	165	100	10	56971	6,21

D mm	L mm	I mm		N° Art.	€ 1 ud.
8	215	150	10	56972	7,79
10	115	50	10	56973	7,07
10	165	100	10	56974	7,55
10	215	150	10	56976	9,00
12	160	110	10	56978	9,36
12	210	160	10	56979	11,17



Set 1489

7 Pcs

Cont. ∅	N° Art.	€
5-6-8 x 115 + 6-8-10-12 x 165 mm	39851	41,77



Ref. **1890**

BROCA-MARTILLO SDS PLUS

SDS plus Rotary Hammer Drill Bit
Foret percussion SDS plus

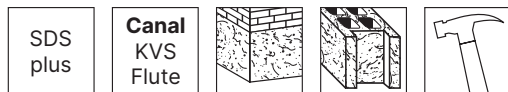

Hormigón
Concrete
Béton

Hormigón Bloque
Concrete Block
Parpaing



Puntos de desbaste efecto "demolición".
Producen micro-fisuras en el material.

"Demolition" effect power breakers.
Produce micro cracks in the material.

Points d'ébauche effet "démolition".
Produit des micro-fissures dans le matériel.



Punta centrado inmediato.
Previene que resbale en superficies lisas.

Immediate centering tip.
Prevent skidding on smooth surfaces.

Pointe Autocentrage immédiat.
Il prévient le glissement sur Surfaces lisses.





Chaflanes de acero corrugado más extenso (+35%).
Previenen daños laterales en la punta.

Enlarged rebar chamfers (+35%).
Prevent side tip damage.

Chanfreins aciers contractés plus étendus (+35%).
Il prévient des dommages aux côtés de la pointe.



D mm	L mm	I mm		Nº Art.	€	D mm	L mm	I mm		Nº Art.	€	D mm	L mm	I mm		Nº Art.	€
4,00	110	50	1	30245	4,20	9,00	160	100	1	11518	6,01	15,00	160	100	1	30286	10,25
4,00	160	100	1	43405	5,11	9,00	210	150	1	11519	6,55	15,00	210	150	1	69917	12,50
5,00	110	50	1	30246	3,04	10,00	110	50	1	30261	4,51	15,00	260	200	1	42773	13,37
5,00	160	100	1	30247	3,96	10,00	160	100	1	30262	5,05	15,00	450	400	1	70642	22,38
5,00	210	150	1	42770	6,32	10,00	210	150	1	18541	6,07	16,00	160	100	1	30291	10,25
5,00	260	200	1	70631	7,67	10,00	260	200	1	30263	8,93	16,00	210	150	1	30292	12,50
5,00	310	250	1	69445	8,47	10,00	310	250	1	30264	10,36	16,00	260	200	1	42774	13,48
5,00	360	300	1	70633	13,32	10,00	450	400	1	30266	16,76	16,00	310	250	1	30294	14,42
5,00	460	400	1	70634	23,06	10,00	600	550	1	30267	23,47	16,00	450	400	1	30295	21,31
5,50	110	50	1	23976	3,53	10,00	800	740	1	70640	36,34	16,00	600	550	1	30296	28,63
5,50	160	100	1	23977	4,44	10,00	1000	950	1	69911	56,08	16,00	800	750	1	30298	46,87
5,50	210	150	1	70636	7,28	11,00	160	100	1	11520	6,63	16,00	1000	950	1	30290	71,65
5,50	260	200	1	69446	9,44	11,00	210	150	1	25600	6,71	18,00	200	150	1	30300	16,05
5,50	310	250	1	70637	11,09	11,00	260	200	1	11521	10,27	18,00	300	250	1	30413	21,34
6,00	110	50	1	30248	3,12	12,00	160	100	1	30270	5,36	18,00	450	400	1	30303	24,33
6,00	160	100	1	18538	3,60	12,00	210	150	1	30271	6,79	18,00	1000	950	1	30299	73,67
6,00	210	150	1	30249	5,96	12,00	260	200	1	30273	9,66	20,00	200	150	1	30306	22,31
6,00	260	200	1	30251	7,66	12,00	310	250	1	42771	13,02	20,00	300	250	1	30309	25,04
6,00	310	250	1	70639	11,97	12,00	450	400	1	30414	15,34	20,00	450	400	1	30311	31,59
6,00	460	400	1	69448	16,02	12,00	600	550	1	30275	24,30	20,00	600	550	1	30312	46,87
6,50	110	50	1	23978	3,58	12,00	800	750	1	69916	39,43	20,00	1000	950	1	30305	74,72
6,50	160	100	1	23979	4,20	12,00	1000	950	1	30269	58,05	22,00	250	200	1	30314	28,66
6,50	260	200	1	59957	9,09	13,00	160	100	1	30276	6,40	22,00	450	400	1	30317	39,91
7,00	110	50	1	30252	4,52	13,00	210	150	1	74789	10,01	22,00	600	550	1	23980	47,78
7,00	160	100	1	30253	4,84	13,00	310	250	1	30278	12,58	22,00	1000	950	1	23986	75,42
7,00	210	150	1	68614	6,14	13,00	450	400	1	55407	20,73	24,00	250	200	1	30319	33,44
7,00	250	200	1	19592	8,71	14,00	160	100	1	30280	7,38	24,00	450	400	1	30322	43,40
8,00	110	50	1	30254	3,77	14,00	210	150	1	30281	10,77	25,00	250	200	1	30324	36,21
8,00	160	100	1	18540	3,95	14,00	260	200	1	42772	12,92	25,00	450	400	1	30327	46,41
8,00	210	150	1	30255	5,38	14,00	310	250	1	30283	13,63	25,00	1000	950	1	23987	83,31
8,00	260	200	1	30256	7,64	14,00	450	400	1	30284	17,92	26,00	250	200	1	11522	45,36
8,00	460	400	1	30257	16,02	14,00	600	550	1	30285	26,61	26,00	450	400	1	30330	51,22
8,00	1000	950	1	70030	55,45	14,00	1000	950	1	30279	63,10						



Línea 1 m - Ref. 1890



∅	5	6	7	8	10	5	6	7	8	10	12	14	6	8	10	12	14	8	16
	L110	L110	L110	L110	L110	L160	L160	L160	L160	L160	L160	L160	L210	L210	L210	L210	L210	L260	L260
Pcs	5	5	3	5	3	5	5	3	3	3	3	3	3	3	3	3	3	2	2

Ref. 4995 - N° Art. 71017: 341,43 €

Display 01 - Ref. 1890 -1-



∅	18	20	22	24	25	8	10	12		
	L300	L300	L250	L250	L250	L460	L450	L450		
Pcs	1	1	1	1	1	2	2	2		
∅	6	8	10	12	14	16	18	20		
	L210	L210	L210	L210	L210	L210	L200	L200		
Pcs	3	3	3	3	3	1	1	1		
∅	4	5	6	7	8	10	5	6	7	8
	L110	L110	L110	L110	L110	L110	L160	L160	L160	L160
Pcs	5	5	5	3	5	3	5	5	3	3

Ref. 4995 - N° Art. 22182: 558,61 €

Display 02 - Ref. 1890 -2-



∅	14	16	18	20	22	24	25	26
	L450	L450	L450	L450	L450	L450	L450	L450
Pcs	3	1	1	1	1	1	1	1
∅	6	8	10	12	10	13	14	16
	L260	L260	L260	L260	L310	L310	L310	L310
Pcs	3	3	3	3	3	2	2	2
∅	9	10	11	12	13	14	15	16
	L160	L160	L160	L160	L160	L160	L160	L160
Pcs	2	2	2	3	3	3	2	2

Ref. 4995 - N° Art. 22183: 659,74 €

Display 45 - Ref. 1890



∅	12 L260	14 L310	16 L310	8 L460	10 L450	12 L450	14 L450	16 L450		
Pcs	3	2	2	1	1	2	1	1		
∅	14 L160	16 L160	6 L210	8 L210	10 L210	12 L210	14 L210	10 L260		
Pcs	3	2	5	3	3	3	3	3		
∅	4 L110	5 L110	6 L110	8 L110	10 L110	5 L160	6 L160	8 L160	10 L160	12 L160
Pcs	5	5	5	5	5	5	5	5	4	3

Ref. 4995 - N° Art. 55614: 561,06 €



Display 25 - Ref. 1890



∅	4 L110	5 L110	6 L110	7 L110	8 L110	10 L110	5 L160	6 L160	7 L160	8 L160
Pcs	5	5	5	3	5	3	5	5	3	3

Ref. 4995 - N° Art. 22278: 161,91 €

Display 26 - Ref. 1890



∅	9 L160	10 L160	11 L160	12 L160	13 L160	14 L160	15 L160	16 L160
Pcs	2	2	2	3	3	3	2	2

Ref. 4995 - N° Art. 22604: 133,80 €



Display 27 - Ref. 1890



∅	6	8	10	12	14	16	18	20
	L210	L210	L210	L210	L210	L210	L200	L200
Pcs	3	3	3	3	3	1	1	1

Ref. 4995 - N° Art. 22605: 155,77 €

Display 28 - Ref. 1890



∅	6	8	10	12	10	13	14	16
	L260	L260	L260	L260	L310	L310	L310	L310
Pcs	3	3	3	3	3	2	2	2

Ref. 4995 - N° Art. 22609: 214,01 €

Display 29 - Ref. 1890



∅	18	20	22	24	25	8	10	12
	L300	L300	L250	L250	L250	L460	L450	L450
Pcs	1	1	1	1	1	2	2	2

Ref. 4995 - N° Art. 22612: 240,93 €

Display 30 - Ref. 1890



∅	14	16	18	20	22	24	25	26
	L450	L450	L450	L450	L450	L450	L450	L450
Pcs	3	1	1	1	1	1	1	1

Ref. 4995 - N° Art. 22614: 311,93 €





Ref. **1899**

BROCA-MARTILLO SDS PLUS

SDS plus Rotary Hammer Drill Bit
Foret percussion SDS plus



D mm	L mm	I mm		Nº Art.	€ 1 ud.
5	110	50	10	18706	2,89
5	160	100	10	18707	3,76
6	110	50	10	18710	2,97
6	160	100	10	18712	3,42
6	210	150	10	18714	5,66
7	160	100	10	74777	4,00
8	110	50	10	18715	3,58
8	160	100	10	18716	3,75
8	210	150	10	18717	5,12

D mm	L mm	I mm		Nº Art.	€ 1 ud.
10	110	50	10	18719	4,27
10	160	100	10	18721	4,80
10	210	150	10	18722	5,78
12	160	100	10	18723	5,10
12	210	150	10	18724	6,46
13	160	100	10	74778	6,08
13	210	150	10	74780	9,51
14	160	100	10	74782	7,01
14	210	150	10	74783	10,23



Set **1494**

4 Pcs

Cont. Ø	Nº Art.	€
5×110 6×110 8×160 10×160 mm	11528	18,98

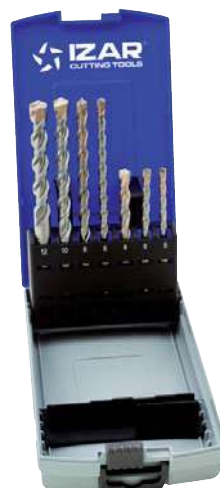

Set **1497**

7 Pcs

Cont. Ø	Nº Art.	€
5-6-8 x 110 + 6-8-10-12 x 160 mm	11529	27,91

Línea 33 cm - 14S2 - Refs. 1899 - 1886 - 1880

SETS BROCAS HORMIGÓN, PARED PRO, PARED

Concrete, Masonry Sets
Jeux béton, maçonnerie



26 cm

	Hormigón Concrete Béton	Pared Pro Concrete Béton	Pared Masonry Maçonnerie
Ref	Set 1494 - Ref. 1899	Set 1487 - Ref. 1886	Set 1488 - Ref. 1880
Diam	5/6×110 + 8/10×160 mm	3-4-5-6-7-8-9-10 mm	3-4-5-6-7-8-9-10 mm
Pcs.	3	5	5

Ref. 4995 - Nº Art. 72194: 235,69 €



Ref. **1695**

CORONA LIGERA PARED PROFESIONAL

Professional Concrete Light Hollow Core Bit
Trépan béton professionnel



Diente MD
Carbide Tipped
Dent Carbure



SDS plus

Rosca Interna M-16
M-16 Internal Thread
Filetage Intérieur M-16



Hormigón
Concrete
Béton

Hormigón Bloque
Concrete Block
Parpaing

Ladrillo
Brick
Brique



- Más robusta
- Nueva geometría de canales mejorada

- Now Stronger
- New improved channel geometry

- Plus robuste
- Nouvelle géométrie améliorée des goujures

D mm	L mm	Nº Art.	€	D mm	L mm	Nº Art.	€	D mm	L mm	Nº Art.	€
30	50	13898	45,34	50	50	13902	67,56	82	50	19032	92,47
35	50	13899	53,68	65	50	13904	70,68	90	50	25207	94,63
40	50	13900	61,54	68	50	19012	74,23	100	50	25208	109,26
45	50	13901	64,80	80	50	19014	74,23				

* Accesorios no incluidos / Accessories not included / Accessoires non inclus

Ref. **1696**

ACCESORIOS – Accessories – Accessoires



Broca Centrar
Center Drill / Foret à Centrer



00001

Broca	D mm	L mm	Nº Art.	€
Drill Bit Mod. Foret Mod.	1	8 120	18857	8,80

Husillo SDS plus
SDS plus Spindle / Arbre SDS plus



00003-5

SDS plus Mod.	L mm	Nº Art.	€
3	105	18858	24,99
4	220	19021	33,25
5	370	19023	47,24

Husillo Hex
Hex Spindle / Arbre Hex



00006-8

HEX Mod.	L mm	Nº Art.	€
6	100	19018	22,02
7	220	19026	28,85
8	370	19030	38,64

Display 05 - Ref. 1695



Ø	SDS plus L110	SDS plus L110	SDS plus L220	SDS plus L350
Pcs	1	1	2	1
Ø	40	50	50	Broca Drill Bit Foret
Pcs	1	1	1	2
Ø	65	68	80	82
Pcs	1	1	1	1

Ref. 4995 - Nº Art. 22418: 698,39 €



HERRAMIENTAS SDS MAX

SDS max Tools

Outils SDS max

Ref. **1892**

BROCA-MARTILLO SDS MAX 4 PUNTAS

4-Cutter SDS max Rotary Hammer Drill Bit

Foret percussion SDS max 4 pointes



Marca desgaste
Wear Marking
Témoin d'usure

Hormigón Reforzado
Reinforced Concrete
Béton armé

Hormigón
Concrete
Béton

Hormigón Bloque
Concrete Block
Parpaing



2 puntas / 2-Cutter / 2-Taillants:

D mm	L mm	I mm	Nº Art.	€
12	340	200	30332	43,17
12	540	400	30333	50,63
12	690	550	30334	76,91
14	340	200	30335	46,70
14	540	400	30336	53,30
15	340	200	30337	50,46
15	540	400	30338	56,68

4 puntas / 4-Cutter / 4-Taillants:

D mm	L mm	I mm	Nº Art.	€
16	340	200	30339	55,25
16	540	400	30340	63,24
16	940	800	60065	106,19
16	1320	1180	60066	203,36
18	340	200	30341	56,68
18	540	400	30342	69,29
18	940	800	60068	106,30
18	1320	1180	60070	209,67
20	320	200	30343	57,57
20	520	400	30344	74,60
20	920	800	30345	106,41
20	1320	1200	60072	251,20
22	320	200	30346	65,91
22	520	400	30347	78,33
22	920	800	30348	115,48
22	1320	1200	60075	268,41
24	320	200	30349	68,22
24	520	400	30350	83,85
25	320	200	30351	70,18
25	520	400	30352	85,28
25	920	800	30353	126,66
25	1320	1200	60077	273,51
26	520	400	30354	86,88
28	370	250	30355	84,57
28	570	450	30356	94,34
28	670	550	30357	116,54
28	920	800	60079	140,51
30	370	250	30358	92,20
30	570	450	30359	98,24
32	370	250	30360	95,93
32	570	450	30361	119,55
32	920	800	30362	164,68
32	1320	1200	60085	291,55
35	370	250	30363	106,58
35	570	450	30364	127,74
35	670	550	30365	150,83
35	920	800	38103	178,84
37	370	250	60088	112,21
37	570	450	60089	129,62
37	920	800	60090	191,21
38	370	250	30366	123,83
38	570	450	30367	131,47
38	720	600	79736	191,27
38	920	800	79737	202,30
40	370	250	30368	135,01
40	570	450	30369	154,56
40	920	800	30370	211,41
40	1320	1200	60093	335,88
45	570	450	30371	222,05
45	920	800	23981	305,68
50	570	450	52952	246,40
52	570	450	52954	299,62

Línea 1 m - Ref. 1892



∅	16	16	18	18	20	20	22	22	25	25	28	28	30	30	32	35
	L340	L540	L340	L540	L320	L520	L320	L520	L320	L520	L370	L570	L370	L570	L570	L570
Pcs	1	1	1	1	1	1	1	1	1	1	1	1	1	1	1	1

Ref. 4995 - Nº Art. 72141: 1.382,84 €



Display 03 - Ref. 1892



∅	16 L540	18 L540	20 L520	22 L520	25 L520	28 L570	30 L570	32 L570	35 L570
Pcs	1	1	1	1	1	1	1	1	1

∅	12 L340	14 L340	16 L340	18 L340	20 L320	22 L320	25 L320	28 L370	30 L370
Pcs	1	1	1	1	1	1	1	1	1

Ref. 4995 - N° Art. 22315: 1.382,84 €



Display 33 - Ref. 1892



49
cm

∅	12 L340	14 L340	16 L340	18 L340	20 L320	22 L320	25 L320	28 L370	30 L370
Pcs	1	1	1	1	1	1	1	1	1

Ref. 4995 - N° Art. 22618: 572,23 €

Display 34 - Ref. 1892



68
cm

∅	16 L540	18 L540	20 L520	22 L520	25 L520	28 L570	30 L570	32 L570	35 L570
Pcs	1	1	1	1	1	1	1	1	1

Ref. 4995 - N° Art. 22619: 810,61 €

Ref. **1894**

CORONA SDS MAX

SDS max Core Cutter
Foret trépan SDS max

¡NUEVO MODELO MEJORADO!
New improved model!
Nouveau modèle amélioré !



SDS max

Nuevo Diseño Especial Hormigón Reforzado
New Special Design for Reinforced Concrete
Nouveau dessin pour béton armé

Hormigón
Concrete
Béton

Hormigón Bloque
Concrete Block
Parpaing



- Punta de centrar 3 cortes para una mayor precisión y vida útil
- 3-cutter centering tip for increased precision and long lifetime
- Pointe de centrage à 3 coupes pour une précision et une durabilité accrues



- 3 alas, con un diseño y solidez del núcleo, para perforaciones rápidas (incluso en hormigón armado) y máxima resistencia a la fractura
- 3-piece outer rim-design and solid core strength, for fast drilling (even in reinforced concrete) and maximum fracture resistance
- 3 arêtes, avec un design et une solidité du noyau, pour des perforations rapides (même dans le béton armé) et une résistance maximale à la rupture



- Dientes de metal duro con una óptima geometría. Innovadoras fases de centrado para prevenir la rotura de los dientes. Un nuevo diseño para un progreso de perforación mayor
- Carbide teeth with optimal geometry. Innovative centering phases for preventing tooth failures. A new design for enhanced drilling progress
- Dents en carbure avec une géométrie optimale. Phases de centrage innovantes pour prévenir la casse des dents. Un nouveau design pour une progression de perçage accrue

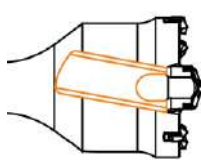

- 3 canales de evacuación de polvo con mayor pendiente para evacuación más rápida y de mayor volumen
- 3 dust channels with a steeper slope for faster and better drilling dust removal
- 3 canaux d'évacuation de la poussière avec une pente plus prononcée pour une évacuation plus rapide et en plus grande quantité

- Diámetro exterior aerodinámico para mayor velocidad y reducción de la fricción
- Aerodynamic outer diameter for higher speed and reduced friction
- Diamètre extérieur aérodynamique pour une vitesse accrue et une réduction de la friction

D mm	L mm	I mm	Nº Art.	€
45	550	450	16864	311,46
45	990	890	16865	376,32
55	550	450	16868	359,90
55	990	890	16869	412,58
65	550	450	16870	388,02
65	990	890	16871	446,52
80	550	450	16873	432,32
80	990	890	16874	557,41



Ref. **1697**

CORONA PERFORADORA TALADRO PERCUTOR

Tapered Hollow Hammer Core Bit
Trépan pour perceuses percussion lourds



Diente MD
Carbide Tipped
Dent Carbure

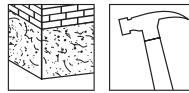

SDS
max

Conicidad 1:8
1:8 Tapered
Conicité 1:8

Hormigón
Concrete
Béton



D mm	L mm	Nº Art.	€
40	100	19035	111,89
50	100	19041	135,40
65	100	19045	174,37
80	100	19047	200,11
90	100	19048	230,56
100	100	19050	250,22
125	100	19051	327,16



* **Accesorios no incluidos**
Accessories not included
Accessoires non inclus

Ref. **1698**

ACCESORIOS – Accesories – Accessoires



Broca Centrar
Center Drill
Foret à centrer



00001

Broca Drill Bit Foret Mod.	D mm	L mm	Nº Art.	€
1	11	120	19054	9,52

Cuña Expulsora Ref. 1104
Drill Drift
Chasse



00002

CM min.	CM max.	L mm	Nº Art.	€
1	2	116	16436	11,57

Husillo SDS max
SDS max Spindle
Arbre SDS max



00003-4

SDS max Mod.	L mm	Nº Art.	€
3	180	19057	51,79
4	450	19058	92,02

Display 06 - Ref. 1697



∅	Llave Key / Clé	Broca Drill Bit / Foret	Broca Drill Bit / Foret	SDS max L180	SDS max L180	SDS max L450
Pcs	3	2	1	2	1	1
∅	40	50	65	80		
Pcs	1	1	1	1		

Ref. 4995 - Nº Art. 22463: 932,43 €



ADAPTADOR iCONNECT

iConnect Adaptor

Adaptateur iConnect

Descripción

iConnect permite taladrar agujeros extremadamente profundos con una broca-martillo corta, de una manera mucho más económica gracias a su sistema de adaptadores y alargadores. Estos alargadores permiten incluso la combinación de un taladro SDS plus con una broca SDS max.

Ventajas

- 2 clicks y ya tiene la broca de la longitud que necesita
- Las dos entradas SDS max del adaptador consiguen una conexión rápida y segura entre la broca y los diferentes alargadores
- Con el adaptador iConnect no hay pérdida de energía, algo habitual en otros sistemas tradicionales de adaptadores
- No hay posibilidad de rotura por causa de una excesiva presión en el área de unión
- Reducción al mínimo de las herramientas necesarias para el taladrado profesional

Uso

Hormigón, pared y piedra natural

Description

iConnect allows drilling extremely deep holes with a short hammer drill bit, in very inexpensive way thanks to this system of adaptors and extensions. These extensions allow even the combination of a SDS plus drilling machine with a SDS max rotary hammer drill bit.

Advantages

- 2 clicks and the tools is the required length
- The adaptor's two SDS max chucks provide a quick and safe connection between the drilling tool and the extension shanks
- With the iConnect adaptor there is no energy loss, normally encountered in traditional adapter systems
- Breakages because of excessive strain in the coupling area are not possible
- Professional drilling tool requirements reduced to a minimum

Use

Concrete, masonry and natural stone

Description

IConnect permet percer des trous très profonds avec un foret percussion court, d'une façon beaucoup plus économique grâce à son système d'adaptateurs et rallonges.

Ces rallonges permettent aussi une combiner un perçage SDS PLUS avec un foret SDS Max.

Avantages

- En 2 clicks vous obtenez la longueur du foret que vous avez besoin.
- Les 2 entrées SDS MAX de l'adaptateur vous permettent une connexion rapide entre le foret et les différents rallonges.
- Avec l'adaptateur IConnect pas de perte d'énergie, comme dans d'autres systèmes.
- Pas de rupture à cause d'une haute pression dans la zone de la connexion d'union.
- Réduire au minimum les outils pour le perçage professionnel.

Emploi

Béton Armé, Béton et Pierre.

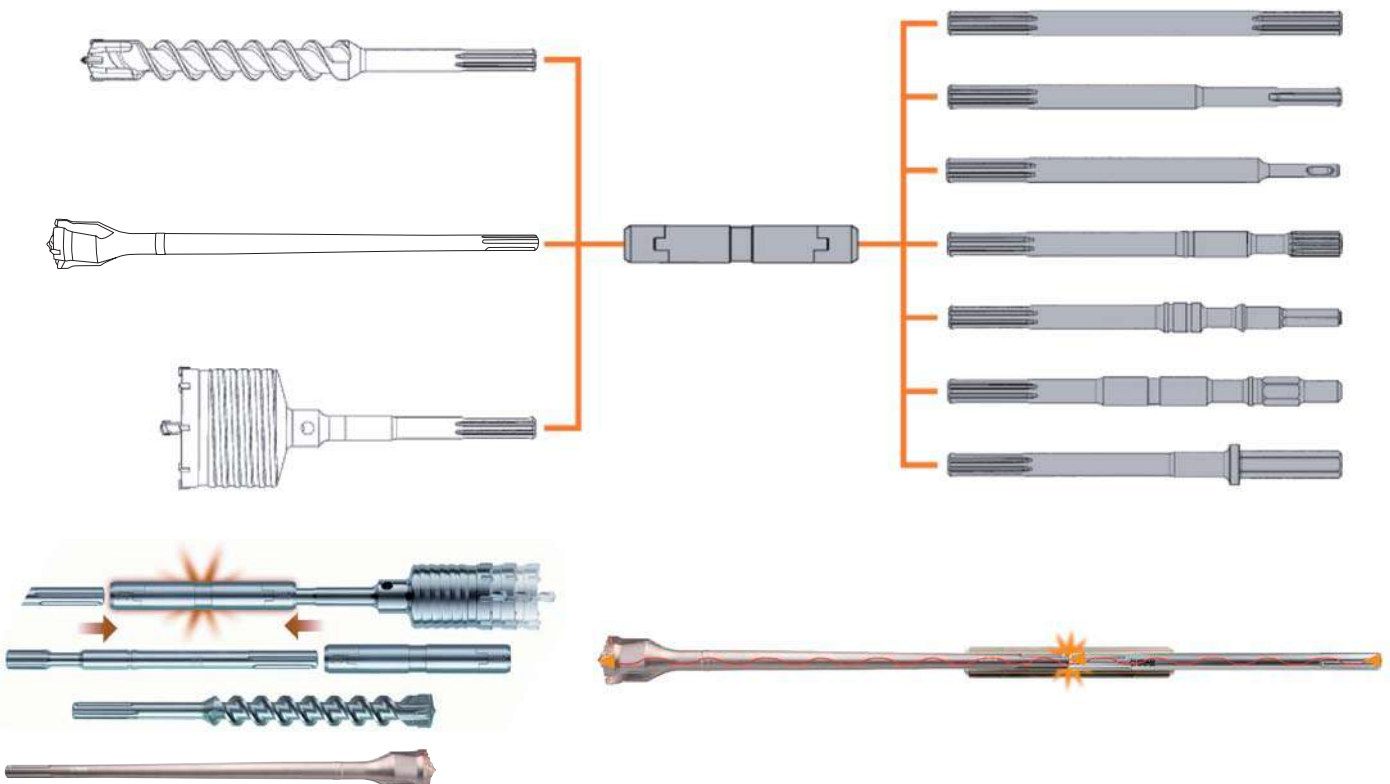

Ref. **1875**

ADAPTADOR SDS MAX

SDS max Adaptor
Adaptateur SDS max



SDS
max



Hormigón
Concrete
Béton

Hormigón Bloque
Concrete Block
Parpaing



Adaptador Mod.	L mm	d mm	Nº Art.	€
1	190	30	56810	96,29



Extensión MAX-MAX Mod.	L mm	Nº Art.	€
0320-MAX	320	56811	39,96
0750-MAX	750	56812	50,12
1100-MAX	1100	56813	67,61



Extensión MAX-PLUS	L mm	Nº Art.	€
0320-PLUS	320	56814	43,94
0750-PLUS	750	56815	55,93





Grasa Grease / Graisse Mod.	Nº Art.	€
2	57504	5,84





CINCELES
Chisels
Burins



Ref. 1872



Ref. 1870



Ref. 1871



Ref. **1870**

CINCEL SDS PLUS

SDS plus Chisel
Burin SDS plus

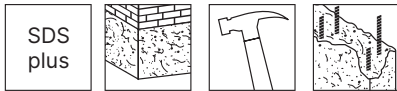

Hormigón Reforzado
Reinforced Concrete
Béton armé

Hormigón
Concrete
Béton



	Mod.	Tipo Type / Type	L mm	I mm	Nº Art.	€
 Puntero / Pointed / Ciseau	00001-250	Puntero / Pointed / Ciseau	250		30372	7,58
 Plano / Flat / Plate	00002-250	Plano / Flat / Plate	250	20	30373	7,58
 Ancho / Wide / Large	00003-200038	Ancho / Wide / Large	200	38	30374	12,98
 Hueco / Hollow / Gouge	00004-240	Hueco / Hollow / Gouge	240	22	30375	15,66
 Alas / Wing-Canal / Ailes	00005-250	Alas / Wing-Canal / Ailes	250	22	54983	37,85
 Azulejo / Tile / Carreau	00009-200038	Azulejo Tile / Carreau	200	38	54985	14,85
	00009-250060		250	60	54986	38,09
 Dentado / Slotting / Denté	00010-200032TCT	Dentado / Slotting / Denté	200	32	54988	100,96
 Ancho / Wide / Large	00011-250040	Ancho / Wide / Large	250	40	82692	16,87

Reafilable
Resharpenable
Réaffûtable

Ref. **1872**

CINCEL SDS MAX

SDS max Chisel
Burin SDS max



SDS
max

Hormigón Reforzado
Reinforced Concrete
Béton armé

Hormigón
Concrete
Béton



Puntero / Pointed / Ciseau



Plano / Flat / Plate



Ancho / Wide / Large



Hueco / Hollow / Gouge



Alas / Wing-Canal / Ailes



Acanalador / Canal / Gouge-Brique



Azulejo / Tile / Carreau



Dentado / Slotting / Denté



Pala / Clay-Spade / Pelle



Asfalto / Asphalt / Asphalte



Abujardar / Bushing / Bouchardage

Mod.	Tipo Type / Type	L mm	I mm	Nº Art.	€
00001-280	Puntero Pointed / Ciseau	280		54989	10,84
00001-400		400		30376	12,84
00001-600		600		23036	17,30
00002-280	Plano Flat / Plate	280	24	54990	10,84
00002-400		400	24	30377	12,84
00002-600		600	24	23037	17,30
00003-360050	Ancho Wide / Large	360	50	23038	19,11
00003-300080		300	80	30378	28,69
00003-350115		350	115	54991	58,62
00004-300	Hueco Hollow / Gouge	300	26	30379	31,85
00005-380035	Alas Wing-Canal / Ailes	380	35	18186	70,57
00008-300032	Acanalador Canal / Gouge-Brique	300	32	54993	35,33
00009-300050	Azulejo Tile / Carreau	300	50	54994	30,35
00009-300080		300	80	54996	31,85
00010-280038TCT	Dentado Slotting / Denté	280	38	54999	94,50
00011-400110	Pala Clay-Spade / Pelle	400	110	55000	77,16
00012-400090	Asfalto Asphalt / Asphalte	400	90	55003	74,52
00013-240045	Abujardar Bushing Bouchardage	240	45x 45	55004	121,77



Línea 33 cm - Ref. 1870



∅	Puntero Pointed Ciseau	Plano Flat Plate	Ancho Wide Large	Hueco Hollow Gouge
Pcs	2	2	2	2

Ref. 4995 - N° Art. 71023: 87,60 €

Display 04 - Refs. 1872 - 1870



SDS MAX Ref. 1872

∅	Puntero Pointed Ciseau L400	Plano Flat Plate L400	Ancho Wide Large 50	Ancho Wide Large 80	Hueco Hollow Gouge	Alas Wing-Canal Ailes L380	Puntero Pointed Ciseau L600	Plano Flat Plate L600
Pcs	2	2	2	2	2	2	1	1

Display 35

Ref. 4995
N° Art. 22621
386,40 €



SDS PLUS Ref. 1870

∅	Puntero Pointed Ciseau	Puntero Pointed Ciseau	Plano Flat Plate	Plano Flat Plate	Ancho Wide Large	Ancho Wide Large	Hueco Hollow Gouge	Hueco Hollow Gouge
Pcs	1	1	1	1	1	1	1	1

Display 36

Ref. 4995
N° Art. 22623
87,60 €

Ref. 4995 - N° Art. 22289: 474,00 €

Ref. **1871**

CINCEL HEXAGONAL 30 mm *

HEX Shank Chisel *

Burin hexagonal *



Hormigón Reforzado
Reinforced Concrete
Béton armé

Hormigón
Concrete
Béton

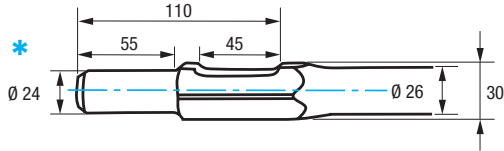

* **Mango rebajado**
Reduced Shank | $\varnothing 24 \times 55$ mm
Queue reduite



00001-400

Puntero / Pointed / Ciseau

400

70710

36,04



00002-400

Plano / Flat / Plate

400

75

70712

64,83



BROCAS MANGO CILÍNDRICO

Straight Shank Drill Bits

Forets queue cylindrique

Ref. **1882**

BROCA PORCELÁNICO
PORCELAIN Drill Bit
Foret PORCELAINE

¡MODELO EXCLUSIVO!

IZAR
CUTTING TOOLS



Sin percusión
No percussion
Sans percussion



H₂O
Refrigerar punta
Point Cooling
Refroidir la pointe



Video



Porcelánico
Porcelain
Porcelaine

Teja, piedra, pizarra, cemento, terrazo, mármol, terracota, calizas
Tile, quarry, slate, cement, terrazzo, marble, terracotta, limestones
Tuile, pierre, ardoise, ciment, terrazzo, marbre, terre cuite, calcaires

D mm	L mm	I mm	d mm		Nº Art.	€
3,00	85	50	3,0	1	13903	12,34
3,50	85	50	3,0	1	13906	12,34
4,00	85	50	3,5	1	13909	12,34
4,50	85	50	4,0	1	13910	12,34
5,00	85	50	4,5	1	14030	13,05
6,00	100	65	5,5	1	14036	13,66
7,00	125	75	6,5	1	14061	15,62
8,00	125	75	7,5	1	14062	16,92
9,00	150	90	8,5	1	14063	20,53
10,00	150	90	9,5	1	14066	20,53
11,00	150	90	10,0	1	14068	22,74
(New) 12,00	150	90	10,0	1	56521	22,74



Set **1482**

4 Pcs

Cont. Ø	Nº Art.	€
4-5-6-8 mm	31004	57,64



Display Ref. 1882



Display Sobremesa
Table Display
Pres. Comptoir

∅	3	4	5	5	6	6	7	8	8	9	10
Pcs	4	4	5	5	5	5	4	2	2	4	4

Ref. 1882 - N° Art. 22661: **660,22 €**

Display 37 - Ref. 1882



∅	4	4	5	5	6	6	8	8	10	10
Pcs	2	2	2	2	2	2	2	2	2	2

Ref. 4995 - N° Art. 22620: **306,00 €**

Display 70 - Refs. 1882 - 1879 - 1883

BROCA, BROCA-CORONA, CORONA DIAMANTE PORCELÁNICO
PORCELAIN Diamond Core Bit & Drill Bit
 Foret, Foret-Trépan et Trépan Diamant **PORCELAINE**



Ref. 1882	∅	4	5	5	6	6	8	8	10
	Pcs	2	3	2	5	5	3	2	2
Ref. 1879	∅	5	6	6	8	8	10	12	14
	Pcs	5	3	3	2	2	2	1	1
Ref. 1883	∅	6	8	10	20	25	32	35	
	Pcs	1	1	1	1	1	1	1	1

Ref. 4995 - N° Art. 82239: **1.078,44 €**

Especial Porcelánico
Special Porcelain
Spécial porcelaine



Ref. **1879**

BROCA-CORONA DIAMANTE PORCELÁNICO

Porcelain Diamond Core Bit
Foret-Trépan diamant PORCELAINE

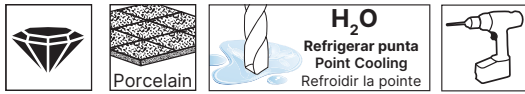

Porcelánico
Porcelain
Porcelaine

Uso / Use / Usage

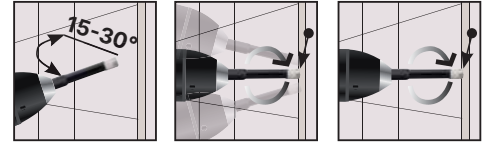

D mm	d mm	L mm	l mm		Nº Art.	€
5,00	8,30	68	10	1	56664	14,82
6,00	8,30	68	10	1	56665	15,51
8,00	8,30	80	10	1	56667	19,22
10,00	8,30	80	10	1	56668	23,31
12,00	8,30	80	10	1	56670	25,82
14,00	8,30	80	10	1	56671	29,85



Set 5 Pcs

Cont. Ø	Nº Art.	€
5-6-8-10-12 mm	57448	98,68

Línea 33 cm - Ref. 1879



Ø	5	6	8	10	12	14
Pcs	3	3	3	3	3	3

Ref. 4995 - Nº Art. 71026: 385,59 €



Ref. **1883**

CORONA DIAMANTE PORCELÁNICO

Porcelain Diamond Core Bit
Trépan diamant PORCELAINE



Video

Porcelánico
Porcelain
Porcelaine

Aplicación

Taladrado limpio de agujeros exactos en placas de piedra, azulejos, cerámicas, dekten y piedra artificial dura. Especial para Porcelánico.

Atención

Comenzar a taladrar con cuidado por un lado y redirigir poco a poco hacia un taladrado completo.

Consejo

Puede conseguir un mejor rendimiento con leves movimientos oscilantes a la corona mientras corta.

Diámetros más usuales

35 mm: Grifería
40 mm: Desagües electrodomésticos
50 mm: Desagües industriales
60 mm: Cajas eléctricas

Application

Clean drilling of exact and Sharp holes in stone plates, tiles, ceramics, dekten and hard artificial stone. Special for Porcelain.

Please note

Start drilling carefully edgewise and slowly continue with full drilling.

Tip

With small tilting movements of the core drill the cutting performance can be improved.

Most usual diameters

35 mm: Water Taps
40 mm: Appliances Pipes
50 mm: Industrial Pipes
60 mm: Electrical Boxes

Application

Perçage trous précision sur tôles pierre, carreaux de faïence, céramiques et dekten. Spécial pour porcelaine.

Attention

Commencer à percer doucement et rediriger petit à petit vers un perçage complet.

Conseil

Vous pouvez avoir une meilleure performance avec faibles mouvements variables sur le trépan dans la coupe.

Diamètres plus usuels

35 mm: Robinetterie
40 mm: Déversoirs ménage
50 mm: Déversoirs industriels
60 mm: Boîtes électriques

D mm	L mm	Rosca Thread Filet	N° Art.	€
6	63	M14	34506	36,35
8	63	M14	34353	37,38
10	63	M14	34507	41,48
12	63	M14	34508	45,56
14	63	M14	55532	54,79
16	90	M14	81515	55,30
18	90	M14	55533	55,81
20	90	M14	55534	56,83
25	90	M14	55535	64,00
32	90	M14	55536	71,17

D mm	L mm	Rosca Thread Filet	N° Art.	€
35	90	M14	34510	72,71
40	90	M14	34511	84,99
45	90	M14	55538	94,21
50	90	M14	34512	101,89
55	90	M14	55539	107,53
60	90	M14	34513	108,05
68	90	M14	55541	118,78
75	90	M14	34516	131,08
82	90	M14	55542	142,86
110	90	M14	69797	258,97



Mod. 00021

Husillo Mango Hexagonal disponible en [pag. 95](#)

Hex Shank Spindle available in [page 95](#)

Arbre queue hexagonal disponible à la [pag. 95](#)

Línea 1 m - Ref. 1883



ø	6	8	10	12	14	18	20	25	32	35	40	45	50
Pcs	1	1	1	1	1	1	1	1	1	1	1	1	1

Ref. 4995 - N° Art. 72145: 817,17 €



Ref. **1877**

BROCA GRANITO

Granite Drill Bit
Foret Granite



BlackGranite



Video

Granito
Granite
Granite

Piedra
Stone
Pierre

Mármol
Marble
Marbre

Silestone

- Ideal para piedras de todo tipo hasta granitos de gran dureza.
- Ideal for all types of stones, from general ones to hard granites.
- Idéal pour tous les types de pierres jusqu'aux granites difficiles à percer.

- El uso de refrigeración con agua permite una mayor eficiencia de corte y durabilidad. También apto en seco.
- Better performance and durability if cooled using water when drilling. Dry cutting also possible
- Le refroidissement à eau permet une meilleure efficacité de coupe et une meilleure durabilité. Coupe à sec également possible.

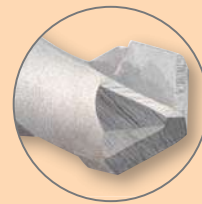

• **Forma de filo asimétrico.**

El rectificado asimétrico de la punta de metal duro reduce la resistencia al corte, permitiendo una perforación del material de trabajo con menor esfuerzo de torsión.

• **Asymmetric cutting edge shape.**

The asymmetric grinding of the carbide tip reduces cutting resistance, allowing the work material drilling with a lower torque.

• **Arête de coupe asymétrique.**

La réctification asymétrique de la pointe en carbure réduit la résistance à la coupure, permettant le perçage du matériau de travail avec une torsion plus faible.

D mm	L mm	l mm	d mm	RPM		N° Art.	€
3,00	85	50	3,00	2000-2500	1	76539	9,89
3,50	85	50	3,00	2000-2500	1	76540	9,89
4,00	85	50	3,50	2000-2500	1	76543	9,89
4,50	85	50	4,00	2000-2500	1	76544	9,89
5,00	85	50	4,50	2000-2500	1	76545	10,36
6,00	100	65	5,50	1500-2000	1	76547	10,46
7,00	125	75	6,50	1500-2000	1	76548	12,52
8,00	125	75	7,50	1000-1500	1	76549	13,56
9,00	150	90	8,50	1000-1500	1	76550	16,44
10,00	150	90	9,50	1000-1500	1	76553	16,44



Display
69



29 cm

ø	4	4	5	5	6	6	8	8	10	10
Pcs	2	2	3	3	3	3	3	3	2	2

Ref. 4995 - N° Art. 81880: 311,60 €



Una broca para TODOS los materiales

One Drill Bit for ALL Materials

Un foret pour TOUS les matériaux

Ref. **1876**

BROCA PUNTA METAL DURO MULTIPROPÓSITO

MultiPurpose Carbide Tipped Drill Bit
Foret pointe carbure Multifonction

New!



MULTIMAT

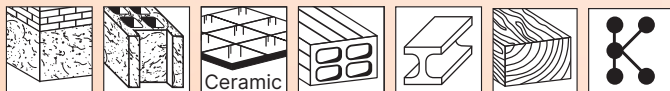

Video

- Hormigón**
Concrete
Béton
- Ladrillo**
Brick
Brique
- Cerámica**
Ceramics
Céramique
- Porcelánico Blando**
Soft Porcelain
Porcelaine tendre
- Aceros**
Steels
Aciers
- Madera**
Wood
Bois
- Plásticos**
Plastics
Plastiques

D mm	L mm	I mm		Nº Art.	€
3	70	35	1	25533	4,46
4	75	40	1	25534	4,27
5	85	50	1	25536	4,66
6	100	65	1	25539	5,54
8	120	70	1	25542	7,21
10	120	70	1	25546	8,93
12	150	90	1	25549	11,55

D mm	L mm	I mm		Nº Art.	€
6	150	90	1	25540	6,13
8	150	90	1	25543	7,77
10	150	90	1	25548	9,51



- Punta de metal duro con afilado exclusivo IZAR
 - Apta para trabajar con percusión (hormigón) y rotación (ladrillo, cerámica, chapa, madera y plásticos)
 - Canales amplios, mejor desahogo del polvo / viruta
 - Permite trabajo en seco, optimizado con refrigeración
 - Perforación con precisión
 - Geometría innovadora que permite una rápida perforación
 - Tratamiento superficial IZAR BLUE, evita la adherencia del polvo / viruta
- Carbide Tip with exclusive Sharpening
 - Suitable for working with Percussion (Concrete) & Rotation (Brick, Ceramics, Sheets, Wood & Plastic)
 - Wide Flutes, better dust / chip relief
 - Dry Running allowed, optimized with Cooling
 - Drilling with Precision
 - Innovative Geometry that allows Fast Drilling
 - IZAR BLUE Surface Treatment, prevents the adhesion of dust / chips
- Pointe carbure avec affûtage exclusif
 - Convient pour travailler avec percussion (béton) et rotation (brique, céramique, tôle, bois et plastique)
 - Goujure large, meilleur soulagement des poussières / copeaux
 - Travail à sec, optimisé avec réfrigération
 - Perçage avec précision
 - Géométrie innovante qui permet un perçage rapide
 - Traitement de surface IZAR BLUE, empêche l'adhérence des poussières / copeaux



Una broca para TODOS los materiales
 One Drill Bit for ALL Materials
 Un foret pour TOUS les matériaux



Set 1876

Set 6 Pcs

Cont. Ø	Nº Art.	€
3-4-5-6-8-10 mm	70478	35,07

Display 72 - Ref. 1876



Ø	3	4	5	5	6	6	8	8	10	12
Pcs	5	5	5	5	5	5	5	5	5	5

Ref. 4995 - Nº Art. 40228: 320,15 €

Display 09 - Refs. 1880 - 1836 - 1876

BROCAS PARED, VIDRIO, MULTIPROPÓSITO
 Masonry, Glass, MultiPurpose Drill Bits
 Forets maçonnerie, verre, multifonction



Ref. 1880	Ø	3 L60	4 L75	5 L85	6 L100	7 L100	8 L120	9 L120	10 L120	12 L150	14 L150
	Pcs	5	5	10	10	5	6	3	3	3	3
Ref. 1836	Ø	3	4	4	5	5	6	6	8	8	10
	Pcs	5	3	2	3	2	3	2	3	2	5
Ref. 1876	Ø	3	4	5	5	6	6	8	8	10	12
	Pcs	5	5	5	5	5	5	5	5	5	5

Ref. 4995 - Nº Art. 22410: 626,88 €

Ref. **1821** New!

Broca Pared Pro 4Z+ Mango 3 Planos

3-Flat Shank 4Z+ Professional Concrete Drill Bit

Foret béton professionnel 4Z+ queue 3 plans



No patina - Extra Grip - Pas de glissement

Ref. **1821**

BROCA PUNTA METAL DURO PARED PRO 4Z+ MANGO 3 PLANOS

3-Flat Shank 4Z+ Professional Concrete Carbide Tipped Drill Bit
Foret pointe carbure béton professionnel 4Z+ queue 3 plans

New!

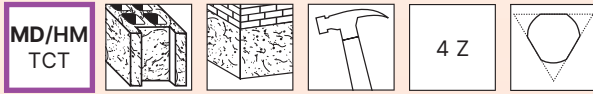

Hormigón Concrete Béton
Hormigón Bloque Concrete Block Parpaing

- Punta centradora de Metal Duro de alto rendimiento
- Perforación precisa debido a las 4 puntas
- El mango de 3 planos evita el patinado
- Óptima evacuación del polvo que evita el calentamiento de la broca
- Más eficiente que una broca convencional
- High performance Carbide centering tip
- Precise drilling due to the 4 cutter point
- 3 Flat-shank for Extra Grip which prevents slipping
- Optimal dust evacuation that prevents the bit from heating up
- More efficient than a conventional drill bit
- Pointe de centrage en carbure de haut rendement
- Perçage précis grâce aux 4 pointes
- La queue à 3 plans évite le glissement
- Évacuation optimale de la poussière évitant le chauffage du foret
- Plus efficace qu'un foret conventionnel

D mm	L mm	I mm		Nº Art.	€
5	85	50	1	26220	2,39
5,5	85	50	1	84585	2,48
6	100	60	1	26221	2,58
7	100	60	1	84586	3,08
8	120	80	1	26285	3,44
9	120	80	1	84587	4,32
10	120	80	1	26287	4,32
11	150	100	1	84588	5,56
12	150	90	1	26360	6,49
13	150	100	1	84589	8,11
14	150	80	1	84590	9,56
16	150	80	1	84591	17,42

D mm	L mm	I mm		Nº Art.	€
5	150	100	1	84571	3,31
6	150	100	1	84572	4,06
8	200	150	1	84573	6,28
10	200	150	1	84575	7,73
12	200	150	1	84599	7,88



Set 5 Pcs

D mm	Nº Art.	€
5, 6, 8, 10, 12	69406	19,22



6 Sets

Nº Art.	€
69408	109,55

Línea 33 cm - Ref. 1821

New!

∅	5	6	8	10	12
Pcs	10	10	10	10	5

Ref. 4995 - Nº Art. 84075: 159,75 €

Ref. **1886**

BROCA PUNTA METAL DURO PARED PROFESIONAL

Professional Concrete Carbide Tipped Drill Bit
Foret pointe carbure béton professionnel



MD/HM
TCT



Hormigón
Concrete
Béton

Hormigón Bloque
Concrete Block
Parpaing

D mm	L mm	I mm		Nº Art.	€
3,0	60	35	1	30232	2,02
4,0	75	45	1	18525	2,02
5,0	85	40	1	18526	2,05
5,5	85	40	1	23983	2,13
6,0	100	55	1	18528	2,21
6,5*	100	55	1	23984	2,41
7,0	100	55	1	18529	2,65
8,0	120	70	1	18531	2,96
9,0	120	70	1	18532	3,71
10,0	120	70	1	18534	3,71
11,0	150	90	1	17858	4,77
12,0	150	90	1	18535	5,57
13,0	150	90	1	30234	6,96
14,0	150	90	1	18537	8,21
16,0	150	90	1	30235	14,96

D mm	L mm	I mm		Nº Art.	€
5,0	150	80	1	30176	2,84
6,0	150	80	1	30200	3,48
8,0	200	130	1	30208	5,39
10,0	200	130	1	30214	6,63
12,0	200	130	1	30222	6,77



* Diam. hasta fin de existencias / while stock lasts / jusqu'à la fin de stock

Línea 1 m - Ref. 1886



Ø	3	4	5	6	7	8	9	10	12	14	16
Pcs	10	10	10	10	10	10	10	10	10	10	10

Ref. 4995 - Nº Art. 71100: 500,70 €



Ref. **1846**

BROCA PUNTA METAL DURO PARED PRO EXTRA LARGA

Extra Long Professional Concrete Carbide Tipped Drill Bit
Foret pointe carbure béton professionnel extra-longue



MD/HM
TCT



Serie Extra Larga
Extra Long Series
Série extra-longue

Hormigón
Concrete
Béton

Hormigón Bloque
Concrete Block
Parpaing

D mm	L mm	I mm		Nº Art.	€
6	400	300	1	30202	6,28
8	400	300	1	30212	6,28
10	400	300	1	30216	6,57
12	400	300	1	30227	7,07
14	400	300	1	30233	8,98
16	400	300	1	30237	15,71
18	400	300	1	30207	19,65
20	400	300	1	30225	21,77
22	400	300	1	16474	25,05
24	400	300	1	16475	25,94
25	400	300	1	16476	29,62

D mm	L mm	I mm		Nº Art.	€
8	600	450	1	76910	10,27
10	600	450	1	30218	10,75
12	600	450	1	30229	11,72
14	600	450	1	30236	14,20
16	600	450	1	30238	18,13
18	600	450	1	16477	24,38
20	600	450	1	16478	28,28



Línea 1 m - Ref. 1846



ø	6	8	10	12	14	16	18	20	22	24	25	10	12	14	16	18	20
	L400	L400	L400	L400	L400	L400	L400	L400	L400	L400	L400	L600	L600	L600	L600	L600	L600
Pcs	2	2	2	2	2	2	2	1	1	1	1	2	2	2	2	2	1

Ref. 4995 - Nº Art. 72150: 430,10 €

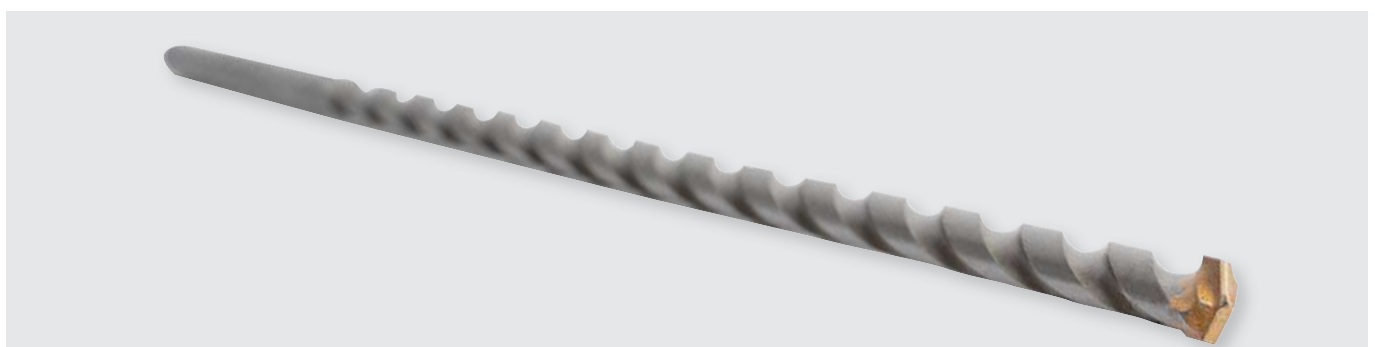

Display 07 - Refs. 1846 - 1886



Ref. 1846	∅	12	8	10	12	14	16	18	20		
	Pcs	L200	L400	L400	L400	L400	L400	L400	L400		
Ref. 1886	∅	10	12	14	16	5	6	8	10		
	Pcs	L120	L150	L150	L150	L150	L150	L200	L200		
Ref. 1886	∅	3	4	5	5	6	6	7	8	8	9
	Pcs	L60	L75	L85	L85	L100	L100	L100	L120	L120	L120

Ref. 4995 - N° Art. 22191: 622,07 €

Display 52 Mixto PRO - Refs. 1886 - 1641 - 1004



BROCAS MULTI INOX + PARED PRO + MADERA PRO

Multi-Stainless + Concrete Pro + Wood Pro Drill Bits

Forets Multi INOX + béton pro + bois pro

Ref. 1886	∅	3	4	5	6	7	8	9	10	12	14
	Pcs	5	5	10	10	5	5	3	3	3	3
Ref. 1641	∅	3	3	4	4	5	5	6	6	8	10
	Pcs	3	2	3	2	3	2	3	2	5	5
Ref. 1004	∅	1	2	3	3,5	4	4,5	5	6	8	10
	Pcs	2	2	3	3	5	5	5	5	5	3

Ref. 4995 - N° Art. 68575: 505,89 €

Display 23 - Refs. 1880 - 1886 - 1640 - 1899

JUEGOS CASSETTE MADERA Y CONSTRUCCIÓN

Wood & Construction Cassette Sets

Jeux cassette bois & construction



Constr. Madera Wood / Bois	Set 1485 - Ref. 1880 Pared Masonry / Béton 5 Pcs.	Set 1486 - Ref. 1886 Pared Pro Masonry Pro / Béton Pro 5 Pcs.	Set 1435 - Ref. 1640 Madera Wood / Bois 5 Pcs.	Set 1438 - Ref. 1640 Madera Wood / Bois 8 Pcs.
	Pcs	5	5	5
Constr.	Set 1488 - Ref. 1880 Pared Masonry / Béton 8 Pcs.	Set 1487 - Ref. 1886 Pared Pro Masonry Pro / Béton Pro 8 Pcs.	Set 1494 - Ref. 1890 SDS plus 4 Pcs.	
	Pcs	5	5	3

Ref. 4995 - N° Art. 22372: 430,09 €



Sets. Ref. 1886



Set **1486**

5 Pcs

Cont. Ø	Nº Art.	€
4-5-6-8-10 mm	30220	14,96



Set **1487**

8 Pcs

Cont. Ø	Nº Art.	€
3-4-5-6-7-8-9-10 mm	21653	24,58

Línea 33 cm - 14S1

SETS BROCAS METAL, PARED PRO, PARED, MADERA

Metal, Concrete, Masonry, Wood Sets
Jeux Métal, Béton, Maçonnerie, Bois



	Metal Metal Métal	Pared Pro Concrete Béton	Pared Masonry Maçonnerie	Madera Wood Bois
Ref	Set 1462 - Ref. 1010	Set 1486 - Ref. 1886	Set 1485 - Ref. 1880	Set 1435 - Ref. 1640
Diam	2-3-4-5-6-8 mm	4-5-6-8-10 mm	4-5-6-8-10 mm	4-5-6-8-10 mm
Pcs.	5	5	5	5

Ref. 4995 - Nº Art. 72193: **186,25 €**

Línea 33 cm - 14S2

SETS BROCAS HORMIGÓN, PARED PRO, PARED

Concrete, Masonry Sets
Jeux Béton, Maçonnerie



	Hormigón Concrete Béton	Pared Pro Concrete Béton	Pared Masonry Maçonnerie
Ref	Set 1494 - Ref. 1899	Set 1487 - Ref. 1886	Set 1488 - Ref. 1880
Diam	5/6×110 + 8/10×160 mm	3-4-5-6-7-8-9-10 mm	3-4-5-6-7-8-9-10 mm
Pcs.	3	5	5

Ref. 4995 - Nº Art. 72194: **235,69 €**

Ref. **1880**

BROCA PUNTA METAL DURO PARED STANDARD

Standard MASONRY Carbide Tipped Drill Bit
Foret pointe carbure MAÇONNERIE standard



MD/HM
TCT



Ladrillo
Brick
Brique

D mm	L mm	l mm	d mm		Nº Art.	€
3	60	30	2,5	1	18495	0,79
4	75	40	3,2	1	18496	0,80
5	85	50	4,0	1	18498	0,91
6	100	60	4,8	1	18499	1,02
7	100	60	5,2	1	18501	1,15
8	120	80	6,2	1	18502	1,27
9	120	80	7,5	1	18504	1,44
10	120	80	7,5	1	18505	1,56
11	150	85	8,5	1	30178	2,46
12	150	85	8,5	1	18507	2,65

D mm	L mm	l mm	d mm		Nº Art.	€
13	150	95	10,0	1	30180	3,01
14	150	95	10,0	1	18508	3,87
16	150	95	14,0	1	30184	5,98
18	160	105	16,0	1	30188	6,84
20	160	105	18,0	1	30190	8,39
22	160	105	19,0	1	30192	9,83
25	160	105	22,5	1	30194	12,15



D mm	L mm	l mm	d mm		Nº Art.	€
5	150	85	4,0	1	30174	1,47
6	150	85	4,8	1	30196	1,58

D mm	L mm	l mm	d mm		Nº Art.	€
6	200	135	4,8	1	30198	1,88
8	200	135	7,5	1	30211	2,19
10	200	135	8,5	1	30412	2,97
12	200	135	8,5	1	30224	3,63
14	200	135	12,0	1	30228	4,60

Línea 1 m - Ref. 1880



∅	3	4	5	6	7	8	9	10	12	14
Pcs	10	10	10	10	10	10	10	10	10	10

Ref. 4995 - Nº Art. 71032: **154,60 €**



Display 08 - Ref. 1880



Ref. 1880	∅	16 L150	5 L150	6 L150	6 L200	8 L200	10 L200	12 L200	14 L200		
	Pcs	5	5	10	10	10	5	5	5		
Sets 1485 1488	∅	3 L60	4 L75	5 L85	6 L100	7 L100	8 L120	9 L120	10 L120	12 L150	14 L150
	Pcs	10	10	10	10	10	10	5	5	5	5
	∅	Set 1485 - Ref. 1880			Set 1488 - Ref. 1880			Set 1485 - Ref. 1880			
	Pcs	5			5			5			

Ref. 4995 - N° Art. 22311: 387,30 €

Display 09 - Refs. 1880 - 1836 - 1876

BROCAS PARED, VIDRIO, MULTIPROPÓSITO

Masonry, Glass, MultiPurpose Drill Bits
Forets maçonnerie, verre, multifonction



Ref. 1880	∅	3 L60	4 L75	5 L85	6 L100	7 L100	8 L120	9 L120	10 L120	12 L150	14 L150
	Pcs	5	5	10	10	5	6	3	3	3	3
Ref. 1836	∅	3	4	4	5	5	6	6	8	8	10
	Pcs	5	3	2	3	2	3	2	3	2	5
Ref. 1876	∅	3	4	5	5	6	6	8	8	10	12
	Pcs	5	5	5	5	5	5	5	5	5	5

Ref. 4995 - N° Art. 22410: 626,88 €

Display 51 - Refs. 1880 - 1640 - 1001

BROCAS METAL + PARED + MADERA

Metal + Masonry + Wood Drill Bits

Forets métal + maçonnerie + bois



Ref. 1880	∅	3	4	5	6	7	8	9	10	12	14
	Pcs	10	10	10	10	10	10	5	5	5	5
Ref. 1640	∅	3	4	5	6	8	9	10	12	14	16
	Pcs	10	10	10	10	10	5	5	5	5	5
Ref. 1001	∅	1	2	3	3,5	4	4,5	5	6	8	10
	Pcs	10	10	10	10	10	10	10	5	5	3

Ref. 4995 - N° Art. 68572: 363,47 €

Display 59 - Refs. 1880 - 1640 - 1002

BROCAS SPEED POINT + PARED + MADERA

Speed Point + Masonry + Wood Drill Bits

Forets speed point + maçonnerie + bois



Ref. 1880	∅	3	4	5	6	7	8	9	10	12	14
	Pcs	10	10	10	10	10	10	5	5	5	5
Ref. 1640	∅	3	4	5	6	8	9	10	12	14	16
	Pcs	10	10	10	10	10	5	5	5	5	5
Ref. 1002	∅	2	3	3,5	4	4,5	5	6	7	8	10
	Pcs	10	10	10	10	10	10	5	5	5	3

Ref. 4995 - N° Art. 70099: 364,81 €

Sets - Ref. 1880



Set **1485**

5 Pcs

Cont. Ø	Nº Art.	€
4-5-6-8-10 mm	30215	7,47



Set **1488**

8 Pcs

Cont. Ø	Nº Art.	€
3-4-5-6-7-8-9-10 mm	30219	11,17

Línea 33 cm - 14S1

SETS BROCAS METAL, PARED PRO, PARED, MADERA

Metal, Concrete, Masonry, Wood Sets
Jeux Métal, Béton, Maçonnerie, Bois



	Metal Metal Métal	Pared Pro Concrete Béton	Pared Masonry Maçonnerie	Madera Wood Bois
Ref	Set 1462 - Ref. 1010	Set 1486 - Ref. 1886	Set 1485 - Ref. 1880	Set 1435 - Ref. 1640
Diam	2-3-4-5-6-8 mm	4-5-6-8-10 mm	4-5-6-8-10 mm	4-5-6-8-10 mm
Pcs.	5	5	5	5

Ref. 4995 - Nº Art. 72193: **186,25 €**

Línea 33 cm - 14S2

SETS BROCAS HORMIGÓN, PARED PRO, PARED

Concrete, Masonry Sets
Jeux Béton, Maçonnerie



	Hormigón Concrete Béton	Pared Pro Concrete Béton	Pared Masonry Maçonnerie
Ref	Set 1494 - Ref. 1899	Set 1487 - Ref. 1886	Set 1488 - Ref. 1880
Diam	5/6×110 + 8/10×160 mm	3-4-5-6-7-8-9-10 mm	3-4-5-6-7-8-9-10 mm
Pcs.	3	5	5

Ref. 4995 - Nº Art. 72194: **235,69 €**

Ref. **1460**

SET MIXTO BROCAS

Drill Bit Mix Set
Jeu forets mix



9 Pcs

Cont. Ø	Nº Art.	€
3 Pcs Metal: 5-6-8 3 Pcs Madera/Wood/Bois: 5-6-8 3 Pcs Pared/Masonry/Béton 5-6-8	55610	11,58



Ref. **1836**

BROCA VIDRIO

GLASS Drill Bit
Foret VERRE

¡NUEVO MODELO MEJORADO!
New improved model!
Nouveau modèle amélioré !



**MD
HM**
Carbure



Vidrio
Glass
Verre

Cerámica
Ceramics
Céramique

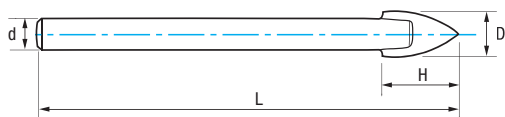

D mm	d mm	L mm	H mm	Art.	Nº Art.	€
3	2,80	70	6	1	30239	5,84
4	3,20	75	8	1	30240	6,42
5	4,00	80	10	1	30241	6,81
6	4,80	85	12	1	30242	7,22
8	6,30	90	16	1	30243	8,84
10	7,50	100	20	1	30244	12,38



New!

4 Pcs



Cont. Ø	Nº Art.	€
4-5-6-8 mm	59168	29,28

Pag. 342

Ref. **1834**

New!



BROCA VIDRIO Y AZULEJO 4Z+
4Z+ Glass and Soft Tiles Drill Bit
Foret verre et carreau 4Z+

Línea 33 cm - Ref. 1836



Ø	3	4	5	6	8	10
Pcs	5	5	5	5	5	5

Ref. 4995 - Nº Art. 71037: 237,55 €

Ref. **1699**

PUNTERO MARCADOR

Pencil Scriber
Traçeur carbure



**MD/HM
TCT**



Aceros
Steel
Aciers

Madera
Wood
Bois

Cerámica
Ceramics
Céramique

Nº Art.	€
1 18856	5,13



CORONAS

Hole Saws

Trépan

Ref. **1645**

SIERRA CORONA METAL / MADERA

METAL / WOOD Hole Saw
Trépan MÉTAL / BOIS



HSSE
5% Co



INOX
Stain-
less

Bimetal

Aceros
<850 N/mm²
Steel / Aciers

INOX
Stainless Steel
Acier INOX

TPI
4-6





Fundición
Cast Iron
Fonte

Cobre
Copper
Cuivre

Madera
Wood
Bois



D mm	L mm	P.G.	Pulgadas Inches / Pouces		Nº Art.	€	D mm	L mm	P.G.	Pulgadas Inches / Pouces		Nº Art.	€
14	37		9/16	1	20094	11,30	57	37		2 1/4	1	30325	19,39
16	37	9	5/8	1	20104	11,30	59	37	48	2 5/16	1	30326	19,39
17	37		11/16	1	21321	11,30	60	37		2 3/8	1	30328	19,39
19	37	11	3/4	1	30250	11,30	63	37		2 31/64	1	18801	21,15
20	37		25/32	1	30258	11,30	64	37		2 1/2	1	30329	21,15
21	37	14	13/16	1	30260	11,30	65	37		2 9/16	1	30331	21,15
22	37	16	7/8	1	30265	11,30	67	37		2 5/8	1	30388	21,15
23	37		14/16	1	30268	11,30	68	37		2 11/16	1	30391	21,15
24	37		15/16	1	30274	11,30	70	37		2 3/4	1	30392	21,15
25	37		1	1	30282	11,86	73	37		2 7/8	1	30393	21,15
27	37		1 1/16	1	30287	12,54	76	37		3	1	30394	21,66
29	37	21	1 1/8	1	30289	12,54	79	37		3 1/8	1	30395	21,67
30	37		1 3/16	1	30293	12,54	83	37		3 1/4	1	30396	21,67
32	37		1 1/4	1	30297	12,54	86	37		3 3/8	1	30397	21,67
33	37		1 5/16	1	30301	12,54	89	37		3 1/2	1	30398	21,67
35	37		1 3/8	1	30302	13,34	92	37		3 5/8	1	30399	25,14
37	37	29	1 7/16	1	30304	13,34	95	37		3 3/4	1	30400	29,49
38	37		1 1/2	1	30307	13,34	98	37		3 7/8	1	30401	31,58
40	37		1 9/16	1	30308	13,36	102	37		4	1	30402	32,99
41	37		1 5/8	1	30310	13,36	105	37		4 1/8	1	52485	36,72
43	37		1 11/16	1	30313	13,36	114	37		4 1/2	1	30403	61,67
44	37		1 3/4	1	30315	16,45	121	37		4 3/4	1	30404	68,72
46	37		1 13/16	1	30316	16,45	127	37		5	1	30405	72,98
48	37	36	1 7/8	1	30318	16,45	140	37		5 1/2	1	30406	78,03
50	37		1 31/32	1	18800	16,45	152	37		6	1	30407	80,91
51	37		2	1	30320	16,45	160	37		6 5/16	1	24475	159,10
52	37		2 1/16	1	30321	19,35	210	37		8 9/32	1	24606	188,23
54	37	42	2 1/8	1	30323	19,35							

Husillos y Adaptadores: Pag. 284 / Spindles & Adaptors: Pag. 284 / Arbres et Adaptateurs: Pag. 284



Línea 1 m - Ref. 1645



ø	16	19	20	22	24	25	27	29	30	32	35	51	64	65	H3A	H4A
Pcs	2	2	2	2	2	2	2	2	2	2	2	2	2	2	2	2

Ref. 4995 - N° Art. 71040: **449,88 €**

Display 19 - Ref. 1645



ø	16	19	20	22	24	25	27	29	30	32	35
Pcs	2	2	2	2	2	2	2	2	2	2	2
Ref. 1645	ø	38	40	41	43	44	48	51	54		
	Pcs	2	2	2	2	2	2	2	2		
ø	60	65	68	70	76	79					
Pcs	2	2	2	2	2	2					
Ref. 1645 1646	ø	83	89	102	H3A	H4A	BR 90	BR 110			
	Pcs	1	1	1	3	3	3	3			

Ref. 4995 - N° Art. 22220: **962,42 €**



Mod. 1
7 Pcs

Básico
Basic
Essentiel



Cont. Ø mm	Nº Art.	€
25-35-43-51-64-H3A-H4A	18232	110,49

Mod. 2
14 Pcs

Completo
Complete
Complet



Cont. Ø mm	Nº Art.	€
19-22-25-32-35-38-43-51-57-60-64-76 H3A-H4A	18234	219,41

Mod. 3
12 Pcs

Electricista
Electrician
Electricien



Cont. Ø mm	Nº Art.	€
16-20-25-32-40-43-51-60-63-65-H3A-H4A	18235	186,19

Mod. 4
8 Pcs

Básico 2
Basic 2
Essentiel 2



Cont. Ø mm	Nº Art.	€
16-20-25-32-40-51-H3A-H4A	58617	111,14

Mod. 5
11 Pcs

Electricista 2
Electrician 2
Electricien 2



Cont. Ø mm	Nº Art.	€
16-20-27-32-40-43-48-51-64-H3A-H4A	58618	162,78

Mod. 6
8 Pcs

Electricista 3
Electrician 3
Electricien 3



Cont. Ø mm	Nº Art.	€
22-35-51-57-68-76-H3A-H4A	66889	137,62

Ref. **1647**

CORONA MULTIPRO

MULTIPRO Hole Saw
Trépan MULTIPRO

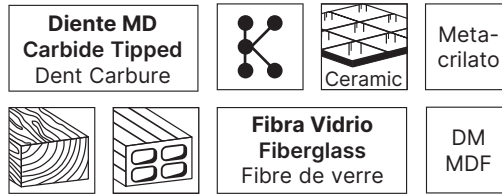

D mm	L mm	Pulgadas Inches / Pouces	Z		Nº Art.	€	D mm	L mm	Pulgadas Inches / Pouces	Z		Nº Art.	€
16	57	5/8	1	1	31855	11,21	65	57	2 3/16	3	1	30710	20,99
19	57	3/4	1	1	30691	11,21	67	57	2 5/8	3	1	30711	20,99
20	57	25/32	1	1	30692	11,21	68	57	2 11/16	3	1	30712	20,99
22	57	7/8	1	1	30693	11,21	70	57	2 3/4	3	1	30713	20,99
24	57	15/16	1	1	31856	11,77	73	57	2 7/8	3	1	30714	20,99
25	57	1	1	1	30694	11,77	76	57	3	4	1	30715	21,48
27	57	1 1/16	1	1	30695	12,44	79	57	3 1/8	4	1	30716	21,49
29	57	1 1/8	1	1	30696	12,44	83	57	3 1/4	4	1	30717	21,49
30	57	1 3/16	1	1	30697	12,44	86	57	3 3/8	4	1	30718	21,49
32	57	1 1/4	1	1	30698	12,44	89	57	3 1/2	4	1	30719	21,49
35	57	1 3/8	1	1	30699	13,27	92	57	3 5/8	4	1	30720	24,94
38	57	1 1/2	1	1	30700	13,27	95	57	3 3/4	4	1	30721	29,24
40	57	1 9/16	2	1	30701	13,27	98	57	3 7/8	4	1	30722	31,31
41	57	1 5/8	2	1	30702	13,27	102	57	4	5	1	30723	32,72
43	57	1 11/16	2	1	31857	16,32	105	57	4 1/8	5	1	30724	35,00
44	57	1 3/4	2	1	30703	16,32	108	57	4 1/4	5	1	30725	37,44
48	57	1 7/8	2	1	30704	16,32	111	57	4 3/8	5	1	30726	40,08
51	57	2	2	1	30705	16,32	114	57	4 1/2	5	1	30727	61,12
54	57	2 1/8	2	1	30706	19,18	121	57	4 3/4	5	1	30728	68,13
57	57	2 1/4	2	1	30707	19,23	127	57	5	5	1	30729	72,36
60	57	2 3/8	3	1	30708	19,23	140	57	5 1/2	5	1	30730	77,36
64	57	2 1/2	3	1	30709	19,98	152	57	6	5	1	30731	80,22
							160	57	6 5/16	5	1	30732	105,18



Husillos y Adaptadores: Pag. 284 / Spindles & Adaptors: Pag. 284 / Arbres et Adaptateurs: Pag. 284

- **Recomendado para terrazas de madera y tarimas sintéticas. Por ejemplo, en colocación de luces de suelo.**
- **Highly recommended for open terrace flooring, both wood and synthetic, e.g. on ground light installations.**
- **Recommandé pour les terrasses en bois et les terrasses synthétiques. Par exemple, lors de l'installation de lumières au sol.**



Línea 1 m - Ref. 1647



∅	25	29	30	35	40	51	60	67	68	73	76	H3C	H4C	BRC 110
Pcs	2	2	2	2	1	1	1	1	1	1	1	3	3	3

Ref. 4995 - N° Art. 72151: 348,01 €

Display 60 - Refs. 1647 - 1646



Ref. 1647	∅	16	19	20	22	24	25	27	29	30	32	35
	Pcs	2	2	2	2	2	2	2	2	2	2	2
Ref. 1647	∅	38	40	41	43	44	48	51	54			
	Pcs	2	2	2	1	1	1	1	1			
Ref. 1646	∅	60	65	68	70	76	79					
	Pcs	1	1	1	1	1	1					
Ref. 1647	∅	83	89	102	H3C	H4C	BRC 110	BRC 110				
	Pcs	1	1	1	3	3	3	3				

Ref. 4995 - N° Art. 32965: 754,58 €



Ref. **1661**

SIERRA CORONA DIENTE MD INTEGRAL

Carbide Teeth Core Drill
Trépan denture carbure

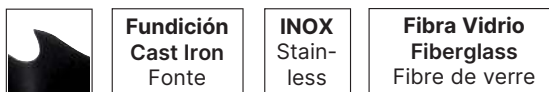
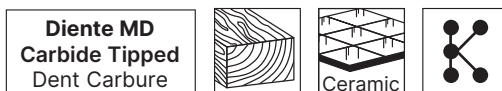

D mm	L mm	Pulgadas Inches / Pouces		Nº Art.	€
19	31	3/4	1	34311	21,84
22	31	7/8	1	34312	23,36
25	31	1	1	34313	24,43
29	31	1 1/8	1	34314	27,42
32	31	1 1/4	1	34315	28,80
35	31	1 3/8	1	34316	32,11
38	31	1 1/2	1	34317	34,04
44	31	1 3/4	1	34318	35,98
48	31	1 7/8	1	34319	39,33
51	31	2	1	34320	41,48
54	31	2 1/8	1	34321	42,51
57	31	2 1/4	1	34322	43,58
60	31	2 3/8	1	34323	45,69
64	31	2 1/2	1	34324	47,78
67	31	2 5/8	1	36831	50,18
70	31	2 3/4	1	34325	53,16
76	31	3	1	34326	53,61
83	31	3 1/4	1	34327	57,39
86	31	3 3/8	1	34328	60,30
89	31	3 1/2	1	34329	63,22
95	31	3 3/4	1	34330	73,33
102	31	4	1	34331	77,60



Husillos y Adaptadores: Pag. 284 / Spindles & Adaptors: Pag. 284 / Arbres et Adaptateurs: Pag. 284









Ref. **1662**

CORONA POLVO MD ELECTRODEPOSITADO

Electrodeposited Carbide Powder Core Drill Bit
Trépan Poudre carbure électrodéposé



Polvo MD Carbide Powder Poudre Carbure	 Ceramic	 Kevlar
 Fibra Vidrio Fiberglass Fibre de verre	 Vidrio Glass Verre	 Ladrillo Brick Brique
		 Cerámica Ceramics Céramique

D mm	L mm	Pulgadas Inches / Pouces		Nº Art.	€
16	36	5/8	1	34289	14,18
19	36	3/4	1	34290	15,50
20	36	25/32	1	34291	16,40
22	36	7/8	1	34292	17,16
25	36	1	1	34293	16,35
29	36	1 1/8	1	34294	17,73
32	36	1 1/4	1	34295	17,88
35	36	1 3/8	1	34296	18,45
38	36	1 1/2	1	34297	20,06
44	36	1 3/4	1	34298	20,12
48	36	1 7/8	1	34299	21,63
51	36	2	1	34300	22,07
54	36	2 1/8	1	34301	21,50
57	36	2 1/4	1	34302	23,55
60	36	2 3/8	1	34303	24,24
64	36	2 1/2	1	34304	24,78
70	36	2 3/4	1	34305	28,39
76	36	3	1	34306	31,42
83	36	3 1/4	1	34307	32,01
86	36	3 3/8	1	34308	34,61
95	36	3 3/4	1	34309	36,65
102	36	4	1	34310	40,10



Husillos y Adaptadores: Pag. 284 / Spindles & Adaptors: Pag. 284 / Arbres et Adaptateurs: Pag. 284



Ref. **1646**

HUSILLOS Y BROCAS CORONAS

Hole Saw Spindles & Drill Bits
Arbres et forets trépan



HSS

Mod.	d mm	Corona Hole Saw Trépan mm	Rosca Thread Filetage		Nº Art.	€
H3A	9,52	14-30	1/2×20 UNF	1	19602	12,61
H4A	9,52	32-210	3/8×18 UNF	1	19603	21,72

MD/HM TCT

Mod.	d mm	Corona Hole Saw Trépan mm	Rosca Thread Filetage		Nº Art.	€
H3C	9,52	14-30	1/2×20 UNF	1	39848	12,61
H4C	9,52	32-210	3/8×18 UNF	1	39849	21,72

MD/HM TCT

New!

Mod.	d mm	Corona Hole Saw Trépan mm	Rosca Thread Filetage		Nº Art.	€
H3S	SDS plus	14-30	1/2×20 UNF	1	13724	16,81
H4S	SDS plus	32-210	3/8×18 UNF	1	13725	33,43

New!

Mod.	D mm	L mm		Nº Art.	€
BR 90	6,35	90	1	19605	3,63
BR 110	6,35	110	1	30019	3,97
BRC 110	7,00	110	1	39850	3,97

Ref. **1642**

ALARGADOR

Extension
Rallonge



Cap. mm	d mm	L mm		Nº Art.	€
9,52	11,00	300	1	69878	20,60



ELECCIÓN HUSILLOS Y BROCAS CORONAS

Hole Saw Spindles & Drill Bits Choice

Choix des arbres et forets trépan

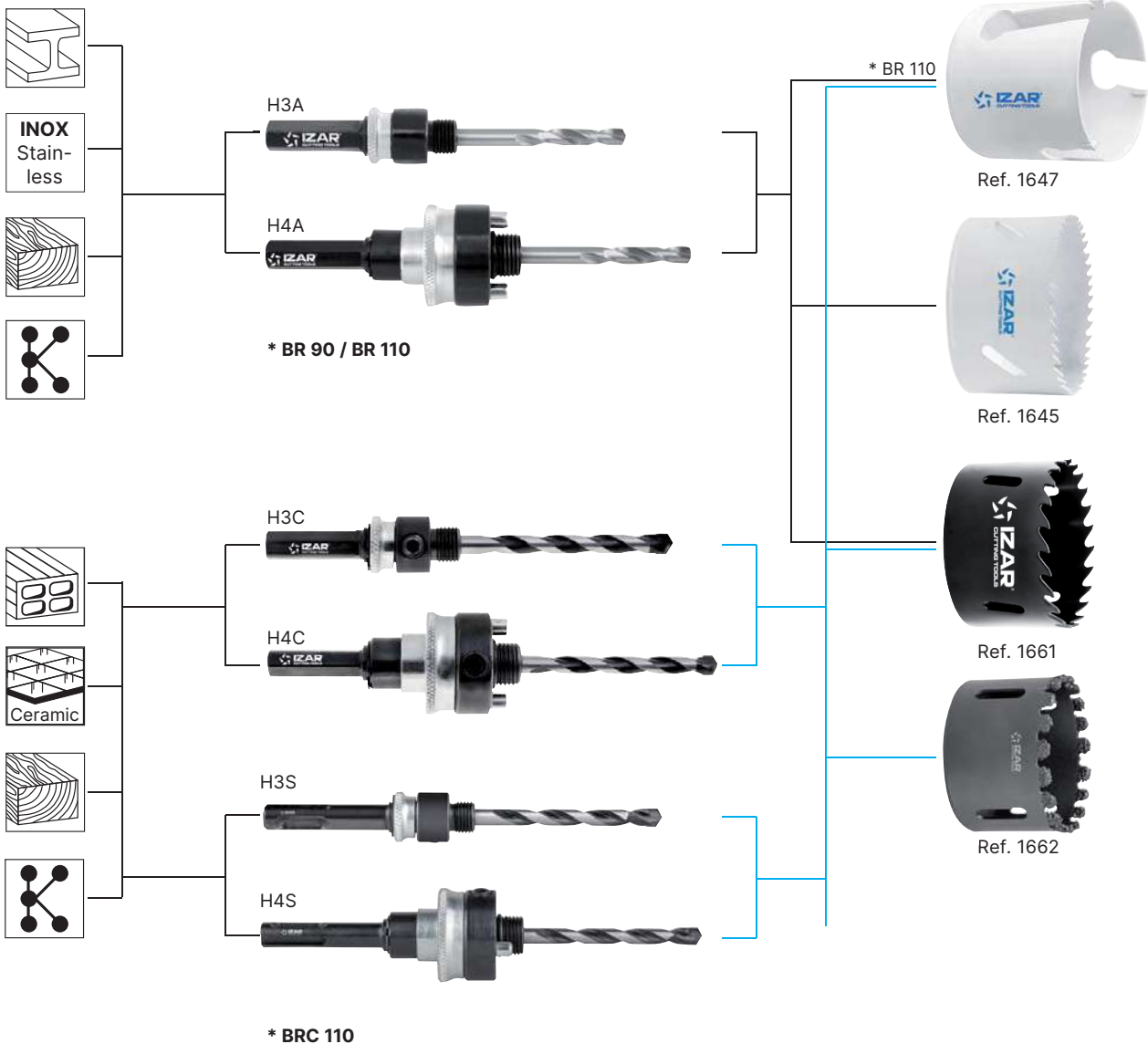

Ref. **1860**

CORONA DIAMANTE HORMIGÓN

CONCRETE Diamond Core Bit

Trépan diamant BÉTON

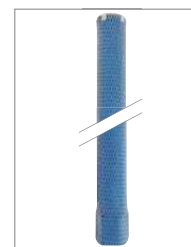

Hormigón Reforzado
Reinforced Concrete
Béton armé

Hormigón
Concrete
Béton

Hormigón Bloque
Concrete Block
Parpaing



D mm	Rosca Thread Filet	L mm	Nº Segmentos	Alto Height Haut Segmento mm	Largo Length Longueur Segmento mm	Ancho Width Largeur Segmento mm	Kw*		Nº Art.	€
32	1" 1/4	450	3	9	24	4	0,7>1,2	1	34333	127,31
42	1" 1/4	450	4	9	24	4	0,7>1,2	1	34334	138,89
52	1" 1/4	450	5	9	24	4	0,7>1,2	1	34335	150,47
62	1" 1/4	450	6	9	24	4	0,7>1,2	1	34336	173,63
72	1" 1/4	450	6	9	24	4	0,7>1,2	1	34337	208,37
82	1" 1/4	450	7	9	24	4	1,2>2,3	1	34338	219,96
92	1" 1/4	450	8	9	24	4	1,2>2,3	1	34339	254,67
102	1" 1/4	450	9	9	24	4	1,2>2,3	1	34340	277,84
112	1" 1/4	450	9	9	24	4	1,2>2,3	1	34341	289,41
122	1" 1/4	450	10	9	24	4	1,2>2,3	1	34342	312,57
127	1" 1/4	450	11	9	24	4	1,2>2,3	1	34332	329,88
132	1" 1/4	450	11	9	24	5	1,2>2,3	1	34343	347,32
142	1" 1/4	450	12	9	24	5	1,2>2,3	1	34344	405,20
152	1" 1/4	450	12	9	24	5	1,2>2,3	1	34357	405,20
162	1" 1/4	450	12	9	24	5	2,3>3,9	1	34345	428,37
172	1" 1/4	450	13	9	24	5	2,3>3,9	1	34346	486,25
182	1" 1/4	450	13	9	24	5	2,3>3,9	1	34347	497,83
200	1" 1/4	450	15	9	24	5	2,3>3,9	1	34349	555,74
225	1" 1/4	450	15	9	24	5	2,3>3,9	1	34350	659,94
250	1" 1/4	450	16	9	24	5	2,3>3,9	1	34351	729,40
300	1" 1/4	450	17	9	24	5	2,3>3,9	1	34352	926,25

*Aplicar esta potencia y usar mucha agua para un rendimiento óptimo de la corona

*Use this power and plenty of water for an optimum performance of the core bit

*Appliquez cette puissance et utilisez de l'eau pour rendement optimale des trépan



DISCOS DIAMANTE

Diamond Cutting Blades

Disques diamant

CUADRO USO DISCOS DIAMANTE

Diamond Disc Use Table

Tableau utilisation disques diamant

		Ref. 1851	Ref. 1852	Ref. 1853	Ref. 1854	Ref. 1855	Ref. 1857	Ref. 1858	Ref. 1861	Ref. 1862	Ref. 1863	Ref. 1864
<p>● Ideal - Ideal - Idéal</p> <p>◐ Adecuado - Suitable - Convenable</p> <p>○ Possible - Possible</p>												
	Hormigón Reforzado Reinforced Concrete Béton armé				●							
	Hormigón Seco Dry Concrete Béton sec	○	◐		●			◐				
	Hormigón Duro Hard Concrete Béton dur		○		●			◐				
	Hormigón Blando Soft Concrete Béton tendre	○	◐			◐						
	Hormigón Universal Universal Concrete Béton universel	◐	●		●		●	●	◐			
	Hormigón Silex Flint Concrete Béton silex						◐		○			
	Ladrillo Brick Brique	○	◐									
	Granito Duro Hard Granite Granite dur			◐	◐					●	◐	●
	Granito Medio Medium Granite Granite moyen		○					○			●	
	Granito Blando Soft Granite Granite tendre	○	◐					◐				
	Mármol Marble Marbre									●		
	Piedra Natural / Dura Natural / Hard Stone Pierre naturelle / Dure				○					○	○	
	Asfalto, Abrasivos Asphalt, Abrasives Asphalte, Abrasifs					●						
	Porcelánico, Gres, Azulejo Duro Porcelain, Stoneware, Hard Tile Porcelaine, Céramique, Carreau dur			●								

Ref. **1851**

SEGMENTADO RÁPIDO OBRA GENERAL

General Works **Fast** Segmented
Segmenté **rapide** général travaux



Hormigón Universal
Universal Concrete
Béton universel

Hormigón Seco
Dry Concrete
Béton sec

Hormigón Blando
Soft Concrete
Béton tendre

Granito Blando
Soft Granite
Granite tendre

Ladrillo
Brick
Brique

D mm	d1 mm	Nº Segmentos	Alto Height Haut Segmento mm	Ancho Width Largeur Segmento mm	Grosor Acero Steel Thickness Épaisseur acier mm	Max R.P.M.		Nº Art.	€
115	22,23	8	12	2,40	1,4	13300	1	60720	8,14
125	22,23	9	12	2,40	1,4	12250	1	60722	9,67
180	22,23	14	12	2,60	1,6	8500	1	67886	19,55
230	22,23	16	12	2,80	1,8	6650	1	60723	24,67
300	25,40	22	12	3,20	2,2	6400	1	60724	48,03
350	25,40	24	12	3,20	2,2	5500	1	60725	59,46



Ref. **1852**

SEGMENTADO LÁSER PROFESIONAL ALTO RENDIMIENTO

Long Life Professional Segmented Laser
Professionnel segmenté laser **haut rendement**



Hormigón Universal
Universal Concrete
Béton universel

Hormigón Seco
Dry Concrete
Béton sec

Hormigón Duro
Hard Concrete
Béton dur

Granito Medio
Medium Granite
Granite moyen

Granito Blando
Soft Granite
Granite tendre

Ladrillo
Brick
Brique

D mm	d1 mm	Nº Segmentos	Alto Height Haut Segmento mm	Ancho Width Largeur Segmento mm	Grosor Acero Steel Thickness Épaisseur acier mm	Max R.P.M.		Nº Art.	€
115	22,23	9	10	2,20	1,4	13300	1	64078	23,64
125	22,23	10	10	2,20	1,4	12250	1	60729	30,94
150	22,23	12	10	2,20	1,4	10200	1	60730	37,34
180	22,23	14	10	2,40	1,6	8500	1	68880	42,61
230	22,23	16	10	2,60	1,8	6650	1	60731	53,96
300	20,00	20	10	3,00	2,2	6400	1	68883	72,78
350	20,00	20	10	3,20	2,4	5500	1	68889	87,08
350	25,40	23	10	3,20	2,4	5500	1	68890	87,08



Ref. **1858**

TURBO OBRA GENERAL

General Works Turbo
Général travaux turbo

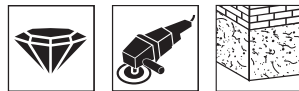

Hormigón Universal
Universal Concrete
Béton universel

Hormigón Seco
Dry Concrete
Béton sec

Hormigón Duro
Hard Concrete
Béton dur

Granito Medio
Medium Granite
Granite moyen

Granito Blando
Soft Granite
Granite tendre



D mm	d1 mm	Nº Segmentos	Alto Height Haut Segmento mm	Ancho Width Largeur Segmento mm	Grosor Acero Steel Thickness Épaisseur acier mm	Max R.P.M.		Nº Art.	€
115	22,23	9	10	2,20	1,4	13300	1	64080	21,16
125	22,23	10	10	2,20	1,4	12250	1	60726	26,75
150	22,23	12	10	2,20	1,4	10200	1	60727	31,77
180	22,23	14	10	2,40	1,6	8500	1	69565	42,61
230	22,23	16	10	2,60	1,8	6650	1	60728	65,71



Ref. **1854**

SOLDADO LÁSER FORMA N

N Form Laser Welded
Soudé laser forme N



Hormigón Reforzado
Reinforced Concrete
Béton armé

Hormigón Seco
Dry Concrete
Béton sec

Hormigón Duro
Hard Concrete
Béton dur

Hormigón Universal
Universal Concrete
Béton universel

Granito Duro
Hard Granite
Granite dur

Piedra Natural
Natural Stone
Pierre naturelle



D mm	d1 mm	Nº Segmentos	Alto Height Haut Segmento mm	Ancho Width Largeur Segmento mm	Grosor Acero Steel Thickness Épaisseur acier mm	Max R.P.M.		Nº Art.	€
125	22,23	10	10	2,20	1,4	12250	1	60740	34,37
180	22,23	14	10	2,40	1,6	8500	1	68895	54,81
230	22,23	15	10	2,60	1,8	6650	1	60741	60,78
300	25,40	20	10	3,00	2,2	6400	1	60742	115,30
350	25,40	23	10	3,00	2,2	5500	1	60743	143,40



Ref. **1853**

TURBO PORCELÁNICO

PORCELAIN Turbo
Turbo PORCELAINE



Porcelánico, Gres, Azulejo Duro
Porcelain, Stoneware, Hard Tile
Porcelaine, Céramique, Carreau dur

Granito Duro
Hard Granite
Granite dur

D mm	d1 mm	Nº Segmentos	Alto Height Haut Segmento mm	Ancho Width Largeur Segmento mm	Grosor Acero Steel Thickness Épaisseur acier mm	Max R.P.M.		Nº Art.	€
115	22,23	Continuo	11	1,30	1,0	13300	1	60732	28,28
125	22,23	Continuo	11	1,30	1,0	12250	1	60739	31,10
230	22,23	Continuo	11	1,50	1,2	6650	1	66552	67,34



Ref. **1855**

SOLDADO LÁSER ASFALTO

ASPHALT Laser Welded
Soudé Laser ASPHALTE



Asfalto, Abrasivos
Asphalt, Abrasives
Asphalte, Abrasifs

Hormigón Blando
Soft Concrete
Béton tendre

Gran protección del segmento para evitar el corte inferior
No undercutting by strong wedge protection
Forte protection du segment pour éviter la coupe inférieure.

D mm	d1 mm	Nº Segmentos	Alto Height Haut Segmento mm	Ancho Width Largeur Segmento mm	Grosor Acero Steel Thickness Épaisseur acier mm	Max R.P.M.		Nº Art.	€
300	25,40	18	10	3,20	2,2	6400	1	60744	82,50
350	25,40	21	10	3,20	2,2	5500	1	60745	105,94
400	25,40	24	10	3,40	2,4	4800	1	60747	134,67



Ref. **1861**

HORMIGÓN FORMA DOBLE COPA

Double Rowed Cup Form Concrete
Béton forme double coupe



Hormigón Universal
Universal Concrete
Béton universel

Hormigón Silex
Flint Concrete
Béton Silex



D mm	d1 mm	Nº Segmentos	Alto Height Haut Segmento mm	Ancho Width Largeur Segmento mm	Grosor Acero Steel Thickness Épaisseur acier mm	Max R.P.M.		Nº Art.	€
115	22,23	12	8	5,00	3,0	13300	1	69473	50,66
125	22,23	14	8	5,00	3,0	12250	1	69475	55,28
180	22,23	28	8	5,00	3,0	8500	1	69477	105,95



Ref. **1857**

TOP HORMIGÓN FORMA COPA Y ALTO RENDIMIENTO

Long Life Y Cup Form Concrete
Top béton forme coupe Y haut rendement



Hormigón Universal
Universal Concrete
Béton universel

Hormigón Silex
Flint Concrete
Béton Silex



Segmentos auto-afilados, superficie fina, tolerancia precisa, eficiente extracción del polvo
Self-sharpened segments, smooth surface, accurate tolerance, efficient dust exhausting
Ségments auto-affûtés, Surface fine, tolerance précise, extraction efficace de la poussière

D mm	d1 mm	Nº Segmentos	Grosor Acero Steel Thickness Épaisseur acier mm	Max R.P.M.		Nº Art.	€
115	22,23	8	3,0	13300	1	60749	61,40
125	22,23	8	3,0	12250	1	60750	69,63
180	22,23	12	3,0	8500	1	64082	136,72



Ref. **1864**

GRANITO FORMA COPA "Y" DE ALUMINIO

Aluminium Cup Wheel for **Granite**
Granite forme coupe "Y" aluminium

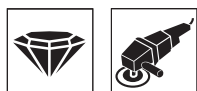

Granito Duro
Hard Granite
Granite Dur

Cuerpo de aluminio, filo amolado fino
Aluminium body, smooth edge grinding
Corps en aluminium, filet meulé fin

D mm	d1 mm	Alto Height Haut Segmento mm	Ancho Width Largeur Segmento mm	Grosor Acero Steel Thickness Épaisseur acier mm	Max R.P.M.		Nº Art.	€
100	22,23	20	7,30	5,5	14500	1	69487	73,70



Ref. **1862**

TURBO GRANITO / MÁRMOL

Turbo Granite / **Marble**
Turbo granite / **marbre**

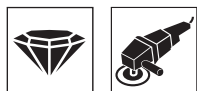

Granito Duro
Hard Granite
Granite dur

Mármol
Marble
Marbre

Piedra Dura
Hard Stone
Pierre dure

Forma en ola, no descascarilla el material
Wave shape, no wobbling during cutting
Forme vaguee, matériel sans décorticage

D mm	d1 mm	Alto Height Haut Segmento mm	Ancho Width Largeur Segmento mm	Grosor Acero Steel Thickness Épaisseur acier mm	Max R.P.M.		Nº Art.	€
115	22,23	7	2,20	1,2	13300	1	69479	29,02
230	22,23	8	2,60	1,8	6650	1	69481	73,70



Ref. **1863**

LÁSER CANTERO

Laser Quarry
Laser carrière



Granito Duro
Hard Granite
Granite dur

Granito Medio
Medium Granite
Granite moyen

Piedra Dura
Hard Stone
Pierre dure

Corte estable y gran rendimiento
Stable cutting high performance
Coupe stable et haute performance

D mm	d1 mm	Nº Segmentos	Alto Height Haut Segmento mm	Ancho Width Largeur Segmento mm	Grosor Acero Steel Thickness Épaisseur acier mm	Max R.P.M.		Nº Art.	€
230	22,23	15	12	3,20	2,2	6650	1	69485	92,12



Ref. **1849**

AMARRE RÁPIDO AMOLADORA

Quick Lock Grinding Tool
Attachement rapide meuleuse



Mod.	Nº Art.	€
1	55946	24,59



New!

6 Pcs

Nº Art.	€
24140	140,16



Ref. **8309**

CUTER HOJA PARTIBLE 9 MM

9 mm Snap-Off Blade Box Cutter
Couteau à lames rétractables 9 mm

MOD. 9



Zamak
5



Mod.	Hoja Blade / Lame mm		Nº Art.	€
9	9	1	34238	10,63

Ref. **8331**

CUCHILLAS REPUESTO

Spare Blades - Lames de rechange

Mod.	Hoja Blade / Lame mm		Nº Art.	€
9	9	10	34241	0,32

Cúter con cuerpo metálico con mecanismo de bloqueo y almacén para cuchillas de repuesto. Incluye 3 cuchillas.

Box Cutter with metal body, locking mechanism and storage for spare blades. Includes 3 blades.

Couteau à lames avec corps en métal, mécanisme de verrouillage et dépôt pour les lames de rechange. Comprend 3 lames.

Ref. **8318**

CUTER HOJA PARTIBLE 18 MM

18 mm Snap-Off Blade Box Cutter
Couteau à lames rétractables 18 mm

New! MOD. 18-ERG



Mod.	Hoja Blade / Lame mm		Nº Art.	€
18-ERG	18	1	83359	4,22

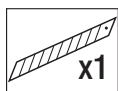

- Cuchilla de 15 Segmentos
- 15 segment blade
- Lame à 15 segments



- Ergonómico. ABS para mejor agarre
- Ergonomic. ABS for better grip
- Ergonomique. ABS pour une meilleure prise



- Portacuchillas inoxidable
- Stainless blade holder
- Porte-lames inoxydable



Box-Pallet
8320

24 uds

Nº Art.	€
10177	96,34

Ref. **8331**

CUCHILLAS REPUESTO - Spare Blades - Lames de rechange



New!

Mod.	Hoja Blade / Lame mm		Nº Art.	€
18-ERG	18	10	83765	0,43

New!



Box-Pallet
8320

20 uds

Nº Art.	€
12676	82,98



Ref. **8318**

CUTER HOJA PARTIBLE 18 MM

18 mm Snap-Off Blade Box Cutter
 Couteau à lames rétractables 18 mm



MOD. 18

Zamak
5



Cúter con cuerpo metálico con mecanismo de bloqueo y almacén para cuchillas de repuesto. Incluye 3 cuchillas.

Box Cutter with metal body, locking mechanism and storage for spare blades. Includes 3 blades.

Couteau à lames avec corps en métal, mécanisme de verrouillage et dépôt pour les lames de rechange. Comprend 3 lames.

Mod.	Hoja Blade / Lame mm		Nº Art.	€
18	18	1	34239	17,48



Ref. **8331**

CUCHILLAS REPUESTO - Spare Blades - Lames de rechange

Mod.	Hoja Blade / Lame mm		Nº Art.	€ 1 ud.
18	18	10	34242	0,46

Ref. **8319**

CUTER HOJA SEGURIDAD 19 MM

19 mm Security Blade Box Cutter
 Couteau à lame sécurité 19 mm



New! MOD. 19S-RET



- Recogida semiautomática de la cuchilla después del corte, evitando lesiones.
- Mango ergonómico
- Cambio de cuchilla rápido y sencillo. Incluye 3 cuchillas

- After cutting, semi-automatic Blade collection, avoiding injuries.
- Ergonomic handle
- Quick Blade change. Includes 3 blades.

- Ramassage semi-automatique de la lame après la coupe, pour éviter des blessures
- Poignée ergonomique
- Changement de lame rapide et facile. Comprend 3 lames.

Mod.	Hoja Blade / Lame mm		Nº Art.	€
19S-RET	59×19×0,61	1	83360	10,26



Box-Pallet
8320

6 uds

Nº Art.	€
10174	58,49



Ref. **8331**

CUCHILLAS REPUESTO

Spare Blades
Lames de rechange



Mod.	Hoja Blade / Lame mm		Nº Art.	€ 1 ud.
New! 19S-RET-TRA	59×19×0,61	10	83766	0,36



Mod.	Hoja Blade / Lame mm		Nº Art.	€ 1 ud.
New! 19S-RET-GAN	Gancho Hook / Crochet	10	83767	0,40



Box-Pallet
8320

20 uds

Nº Art. €
12677 **68,45**



Box-Pallet
8320

20 uds

Nº Art. €
12682 **76,76**

Ref. **8319**

CUTER HOJA SEGURIDAD 19 MM

19 mm Security Blade Box Cutter
Couteau à lame sécurité 19 mm

MOD. 19S



Zamak
5



Cúter metálico con almacén para cuchillas de repuesto.

Metal Box Cutter with storage for spare blades.

Couteau à lames en métal avec dépôt pour les lames de rechange.

Mod.	Hoja Blade / Lame mm		Nº Art.	€
19S	60×19×0,65	1	34240	6,95



Ref. **8331**

CUCHILLAS REPUESTO - Spare Blades - Lames de rechange

Mod.	Hoja Blade / Lame mm		Nº Art.	€ 1 ud.
19S	60×19×0,65	10	34243	0,38



03.

MADERA

Wood
Bois

BROCAS

Drill Bits
Forets

298

FRESAS

Router Cutters
Fraises

314

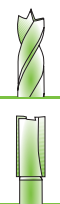

BROCAS

Drill Bits

Forets

Ref. **1641**

BROCA PUNTA CENTRAR PRO

PRO Drill Bit
Foret auto-centreur PRO



- Óptima evacuación de viruta
- Más rápida
- Mejor centrado
- Mayor durabilidad
- Mayor precisión
- Agujeros limpios

- Optimum chipping-off
- Faster
- Better centering
- Longer tool life
- Higher precision
- Clean holes

- Evacuation optimale des copeaux
- Plus rapide
- Meilleur auto-centrage
- Vie plus longue de l'outil
- Meilleure precision
- Trous plus propres



Maderas Duras
Hard Wood
Bois dur

Maderas Tropicales
Tropical Wood
Bois Tropical

Contrachapado
Plywood
Contreplaqué

D mm	L mm	l mm	d mm		Nº Art.	€
3	61	33	3	1	34450	2,01
4	75	43	4	1	34451	2,41
5	86	52	5	1	34452	2,97
6	93	57	6	1	34453	3,43
8	117	75	8	1	34454	5,39
10	133	87	10	1	34455	7,65



Línea 33 cm - Ref. 1641



∅	3	4	5	6	8	10
Pcs	5	5	5	5	5	5

Ref. 4995 - Nº Art. 71044: **119,30 €**



Display 55 - Refs. 1651 - 1641



Ref. 1651	∅	22	24	25	26	28	30				
	Pcs	5	5	5	5	5	5	5			
Ref. 1651	∅	10	12	14	16	18	20				
	Pcs	5	5	5	5	5	5	5			
Ref. 1641	∅	3	3	4	4	5	5	6	6	8	10
	Pcs	5	5	5	5	5	5	5	5	5	5

Ref. 4995 - N° Art. 70074: 435,45 €

Display 58 - Ref. 1641



28
cm

Ref. 1641	∅	3	3	4	4	5	5	6	6	8	10
	Pcs	5	5	5	5	5	5	5	5	5	5

Ref. 4995 - N° Art. 70088: 238,6 €

Display 52 Mixto PRO - Refs. 1886 - 1641 - 1004



BROCAS MULTI INOX + PARED PRO + MADERA PRO
Multi-Stainless + Concrete Pro + Wood Pro Drill Bits
Forets Multi INOX + béton pro + bois pro

Ref. 1886	∅	3	4	5	6	7	8	9	10	12	14
	Pcs	5	5	10	10	5	5	3	3	3	3
Ref. 1641	∅	3	3	4	4	5	5	6	6	8	10
	Pcs	3	2	3	2	3	2	3	2	5	5
Ref. 1004	∅	1	2	3	3,5	4	4,5	5	6	8	10
	Pcs	2	2	3	3	5	5	5	5	5	3

Ref. 4995 - N° Art. 68575: 505,89 €



Ref. **1640**

BROCA PUNTA CENTRAR

Center Point Drill Bit
Foret auto-centreur



CrV

Maderas Blandas
Soft Wood
Bois tendre

D mm	L mm	I mm	d mm		Nº Art.	€
3	61	33	3,00	1	18426	0,70
4	75	43	4,00	1	18427	0,71
5	86	52	5,00	1	18429	0,75
6	97	60	6,00	1	18430	0,95
7	109	69	7,00	1	18432	1,03
8	117	75	8,00	1	18433	1,30
9	125	80	9,00	1	18435	1,52
10	133	87	10,00	1	18436	1,61

D mm	L mm	I mm	d mm		Nº Art.	€
11	142	89	9,95	1	30380	2,02
12	151	96	9,95	1	18438	2,21
13	151	96	9,95	1	30381	2,33
14	151	97	9,95	1	18439	2,55
15	160	100	9,95	1	30382	2,99
16	160	100	9,95	1	30383	3,41
18	180	120	9,95	1	17860	8,66
20	200	130	9,95	1	17861	10,53



Larga / Long / Longue

D mm	L mm	I mm	d mm		Nº Art.	€
6	250	200	6,00	1	55969	2,46
8	250	200	8,00	1	55970	2,80
10	250	200	10,00	1	55971	3,65
12	250	200	9,95	1	55972	4,37



Línea 1 m - Ref. 1640



ø	3	4	5	6	7	8	9	10	11	12	13	14	15	16	18	20
Pcs	10	10	10	10	10	10	5	5	5	5	5	5	5	3	3	3

Ref. 4995 - Nº Art. 71047: 198,35 €



Display 10 - Refs. 1650 - 1640



Ref. 1650 (L 152)	∅	22	24	25	26	28	30	32			
	Pcs	7	5	5	5	5	5	5	5		
Ref. 1650 (L 152)	∅	6	8	10	12	14	16	18	20		
	Pcs	7	7	7	7	7	7	7	7	7	
Ref. 1640	∅	3	4	5	6	8	9	10	12	14	16
	Pcs	10	10	10	10	10	5	5	5	5	5

Ref. 4995 - N° Art. 22184: 342,13 €

Display 51 - Refs. 1880 - 1640 - 1001

BROCAS METAL + PARED + MADERA

Metal + Masonry + Wood Drill Bits

Forets métal + maçonnerie + bois



Ref. 1880	∅	3	4	5	6	7	8	9	10	12	14
	Pcs	10	10	10	10	10	10	5	5	5	5
Ref. 1640	∅	3	4	5	6	8	9	10	12	14	16
	Pcs	10	10	10	10	10	5	5	5	5	5
Ref. 1001	∅	1	2	3	3,5	4	4,5	5	6	8	10
	Pcs	10	10	10	10	10	10	10	5	5	3

Ref. 4995 - N° Art. 68572: 363,47 €



Display 59 - Refs. 1880 - 1640 - 1002

BROCAS SPEED POINT + PARED + MADERA

Speed Point + Masonry + Wood Drill Bits

Forets speed point + maçonnerie + bois



Ref. 1880	∅	3	4	5	6	7	8	9	10	12	14
	Pcs	10	10	10	10	10	10	5	5	5	5
Ref. 1640	∅	3	4	5	6	8	9	10	12	14	16
	Pcs	10	10	10	10	10	5	5	5	5	5
Ref. 1002	∅	2	3	3,5	4	4,5	5	6	7	8	10
	Pcs	10	10	10	10	10	10	5	5	5	3

Ref. 4995 - N° Art. 70099: 364,81 €

Display 23 - Refs. 1880 - 1886 - 1640 - 1899

JUEGOS CASSETTE MADERA Y CONSTRUCCIÓN

Wood & Construction Cassette Sets

Jeux cassette bois & construction



Constr. Madera Wood / Bois		Set 1485 - Ref. 1880 Pared Masonry / Béton 5 Pcs.	Set 1486 - Ref. 1886 Pared Pro Masonry Pro /Béton Pro 5 Pcs.	Set 1435 - Ref. 1640 Madera Wood / Bois 5 Pcs.	Set 1438 - Ref. 1640 Madera Wood / Bois 8 Pcs.
	Pcs	5	5	5	5
Constr.		Set 1488 - Ref. 1880 Pared Masonry / Béton 8 Pcs.	Set 1487 - Ref. 1886 Pared Pro Masonry Pro /Béton Pro 8 Pcs.	Set 1494 - Ref. 1890 SDS plus 4 Pcs.	
	Pcs	5	5	3	

Ref. 4995 - N° Art. 22372: 430,09 €



Sets - Ref. 1640



Set **1435**

5 Pcs

Cont. Ø	Nº Art.	€
4-5-6-8-10 mm	30223	6,57



Set **1438**

8 Pcs

Cont. Ø	Nº Art.	€
3-4-5-6-7-8-9-10 mm	30226	9,88



Set **1460**

9 Pcs

Cont. Ø	Nº Art.	€
3 Pcs Metal: 5-6-8 3 Pcs Madera/Wood/Bois: 5-6-8 3 Pcs Pared/Masonry/Béton 5-6-8	55610	11,58

Línea 33 cm - 14S1

SETS BROCAS METAL, PARED PRO, PARED, MADERA

Metal, Concrete, Masonry, Wood Sets
 Jeux Métal, Béton, Maçonnerie, Bois



	Metal Metal Métal	Pared Pro Concrete Béton	Pared Masonry Maçonnerie	Madera Wood Bois
Ref	Set 1462 - Ref. 1010	Set 1486 - Ref. 1886	Set 1485 - Ref. 1880	Set 1435 - Ref. 1640
Diam	2-3-4-5-6-8 mm	4-5-6-8-10 mm	4-5-6-8-10 mm	4-5-6-8-10 mm
Pcs.	5	5	5	5

Ref. 4995 - N° Art. 72193: 186,25 €



Ref. **1651**

BROCA PLANA GRAN RENDIMIENTO

Heavy Duty Flat Bit
Mèche plate haut rendement



Maderas Blandas
Soft Wood
Bois tendre



D mm	d mm	L mm	I mm		Nº Art.	€	D mm	d mm	L mm	I mm		Nº Art.	€
6,00	6,35	152	38	1	56019	2,68	22,00	6,35	152	42	1	56031	3,99
8,00	6,35	152	38	1	56021	2,68	24,00	6,35	152	46	1	56032	4,97
10,00	6,35	152	38	1	56022	2,83	25,00	6,35	152	46	1	56033	4,97
12,00	6,35	152	42	1	56023	3,11	26,00	6,35	152	46	1	56034	4,97
13,00	6,35	152	42	1	56024	3,11	28,00	6,35	152	46	1	56035	6,38
14,00	6,35	152	42	1	56025	3,24	30,00	6,35	152	46	1	56036	6,73
16,00	6,35	152	42	1	56026	3,24	32,00	6,35	152	46	1	56037	6,73
18,00	6,35	152	42	1	56028	3,99	35,00	6,35	152	46	1	56038	7,78
19,00	6,35	152	42	1	56029	3,99	38,00	6,35	152	46	1	56040	8,82
20,00	6,35	152	42	1	56030	3,99	40,00	6,35	152	46	1	56042	8,88



Set **1651**

8 Pcs



Cont. Ø	Nº Art.	€
12-16-18-20-22-25-28-32 mm	57449	36,40

Línea 1 m - Ref. 1651



Ø	6	8	10	12	14	16	18	20	22	24	25	26	28	30	32	35	38	L305
Pcs	8	8	8	8	8	8	8	8	5	5	5	5	5	5	5	5	5	1

Ref. 4995 - Nº Art. 72169: 493,68 €

Ref. **1653**

ALARGADOR

Extension
Rallonge



L mm	d mm	D mm		Nº Art.	€
305	6,35	15,85	1	23982	10,90



Display 55 - Refs. 1651 - 1641



Ref. 1651	∅	22	24	25	26	28	30				
	Pcs	5	5	5	5	5	5	5			
Ref. 1651	∅	10	12	14	16	18	20				
	Pcs	5	5	5	5	5	5	5			
Ref. 1641	∅	3	3	4	4	5	5	6	6	8	10
	Pcs	5	5	5	5	5	5	5	5	5	5

Ref. 4995 - N° Art. 70074: 435,45 €

Display 56 - Ref. 1651



30
cm

∅	10	12	14	16	18	20		
Pcs	10	10	10	10	10	10	10	

Ref. 4995 - N° Art. 70078: 204,00 €

Display 57 - Ref. 1651



30
cm

∅	22	24	25	26	28	30		
Pcs	5	5	5	5	5	5	5	

Ref. 4995 - N° Art. 70084: 160,05 €

Ref. **1650**

BROCA PLANA

Flat Bit
Mèche plate



Pala
Flat
Plate



Maderas Blandas
Soft Wood
Bois tendre

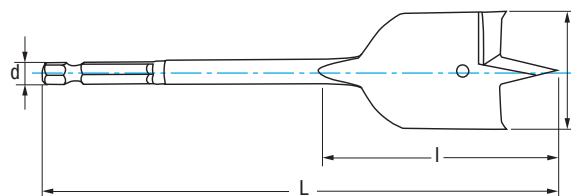

Larga / Long / Longue

D mm	L mm	I mm	d mm		N° Art.	€
6	152	38	6,35	1	30384	1,62
8	152	38	6,35	1	30385	1,62
10	152	38	6,35	1	30386	1,71
12	152	42	6,35	1	30387	1,88
13	152	42	6,35	1	55988	1,93
14	152	42	6,35	1	18457	1,96
16	152	42	6,35	1	18459	2,15
17	152	42	6,35	1	55989	2,29
18	152	42	6,35	1	18460	2,42
19	152	42	6,35	1	55990	2,42
20	152	42	6,35	1	18462	2,42
22	152	42	6,35	1	18463	2,81
24	152	46	6,35	1	18465	3,01
25	152	46	6,35	1	18466	3,41
26	152	46	6,35	1	18468	3,58
28	152	46	6,35	1	18469	3,86
30	152	46	6,35	1	18471	4,07
32	152	46	6,35	1	18472	4,35
35	152	46	6,35	1	55992	4,88
36	152	46	6,35	1	30389	5,02
38	152	46	6,35	1	30390	5,35
40	152	46	6,35	1	17864	5,37

D mm	L mm	I mm	d mm		N° Art.	€
6	400	38	6,35	1	55973	6,82
8	400	38	6,35	1	55974	6,82
10	400	38	6,35	1	55975	7,14
12	400	42	6,35	1	55976	7,90
14	400	42	6,35	1	55977	6,79
16	400	42	6,35	1	55978	7,46
18	400	42	6,35	1	55979	8,41
20	400	42	6,35	1	55980	8,41
22	400	42	6,35	1	55981	9,74
24	400	46	6,35	1	55982	10,44
25	400	46	6,35	1	55983	11,90
28	400	46	6,35	1	55984	13,40
30	400	46	6,35	1	55985	14,13
32	400	46	6,35	1	55986	15,18
35	400	46	6,35	1	55987	17,04



Set **1650**

8 Pcs

Cont. Ø	N° Art.	€
12-16-18-20-22- 25-28-32 mm	66378	23,30



Línea 1 m - Ref. 1650



∅	6	8	10	12	14	16	18	20	22	24	25	26	28	30	32	36	38	L305
Pcs	10	10	10	10	10	10	10	10	5	5	5	5	5	5	5	5	5	1

Ref. 4995 - N° Art. 71051: 346,00 €

Display 10 - Refs. 1650 - 1640



Ref. 1650 (L 152)	∅	22	24	25	26	28	30	32			
	Pcs	7	5	5	5	5	5	5			
Ref. 1650 (L 152)	∅	6	8	10	12	14	16	18	20		
	Pcs	7	7	7	7	7	7	7	7		
Ref. 1640	∅	3	4	5	6	8	9	10	12	14	16
	Pcs	10	10	10	10	10	5	5	5	5	5

Ref. 4995 - N° Art. 22184: 342,13 €



Ref. **1655**

BROCA ESPIRAL TORNILLO EN LA PUNTA

Screw-Point Auger Drill Bit

Foret spirale vis en pointe



CrV

Maderas Duras
Hard Wood
Bois dur

D mm	L mm	I mm	d mm		Nº Art.	€
New! 3	230	155	2,5	1	19792	9,46
New! 4	230	155	3,5	1	19793	9,75
New! 5	230	155	4,5	1	19794	10,04
6	230	155	5,5	1	19139	10,34
7	230	155	6,5	1	66809	10,63
8	230	155	7,5	1	19145	10,91
9	230	155	8,5	1	66811	11,23
10	230	155	9,5	1	19148	11,52
11	230	155	10,5	1	66812	11,76
12	230	155	11,5	1	19154	11,98
13	230	155	12,5	1	66813	12,33
14	230	155	12,5	1	19172	12,68
16	230	155	12,5	1	19187	14,53
18	230	155	12,5	1	19202	18,51
20	230	155	12,5	1	19211	21,02
22	230	155	12,5	1	19226	23,47
23	230	155	12,5	1	66814	24,61
24	230	155	12,5	1	19235	25,76
25	230	155	12,5	1	66815	26,92
26	230	155	12,5	1	27304	28,10
28	230	155	12,5	1	27604	33,17
30	230	155	12,5	1	27630	47,46
32	230	155	12,5	1	29040	47,46

D mm	L mm	I mm	d mm		Nº Art.	€
6	460	385	5,5	1	60683	12,42
8	460	385	7,5	1	19082	13,09
10	460	385	9,5	1	19151	14,26
12	460	385	11,5	1	19163	15,45
14	460	385	12,5	1	19181	18,91
16	460	385	12,5	1	19193	22,40
18	460	385	12,5	1	19205	29,98
20	460	385	12,5	1	19217	33,62
22	460	385	12,5	1	19229	36,98
24	460	385	12,5	1	19238	40,54
26	460	385	12,5	1	27603	44,03
28	460	385	12,5	1	27605	47,71
30	460	385	12,5	1	27680	52,34
32	460	385	12,5	1	29041	58,17

D mm	L mm	I mm	d mm		Nº Art.	€
8	600	530	7,5	1	67750	18,54
10	600	530	9,5	1	15811	21,71
12	600	530	11,5	1	15813	22,35
14	600	530	12,5	1	15816	31,73
16	600	530	12,5	1	15817	37,27
18	600	530	12,5	1	15823	56,15
20	600	530	12,5	1	15828	64,09
22	600	530	12,5	1	15855	71,69



New!

Set **1655**

9 Pcs

Cont. Ø	Nº Art.	€
4-5-6-8-10-12-14-16-18-mm	19795	110,26

Línea 1 m - Ref. 1655



38 cm

ø	6	7	8	9	10	11	12	13	14	16	18	20	22	23	24	25	26	28	30
Pcs	2	2	2	2	2	2	2	2	2	2	2	2	1	1	1	1	1	1	1

Ref. 4995 - Nº Art. 72171: **524,37 €**

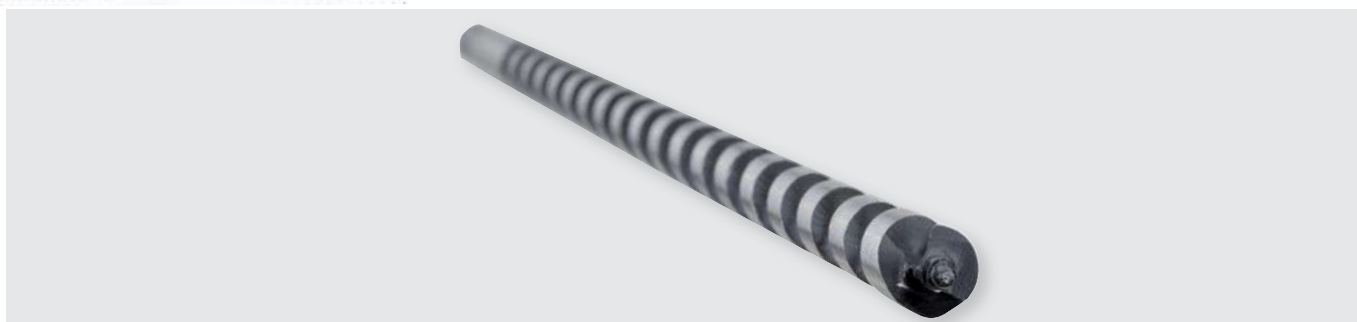



Display 11 - Ref. 1655

∅	18 L460	20 L460	22 L460	24 L460	26 L460	28 L460	30 L460	32 L460
Pcs	2	2	1	1	1	1	1	1
∅	26 L230	28 L230	30 L230	32 L230	10 L460	12 L460	14 L460	16 L460
Pcs	1	1	1	1	2	2	2	2
∅	10 L230	12 L230	14 L230	16 L230	18 L230	20 L230	22 L230	24 L230
Pcs	2	2	2	2	2	2	1	1

Ref. 4995 - N° Art. 22307: 934,91 €

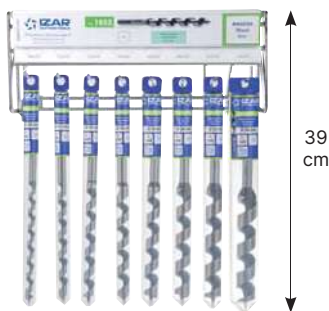

Display 38 - Ref. 1655

∅	10 L230	12 L230	14 L230	16 L230	18 L230	20 L230	22 L230	24 L230
Pcs	2	2	2	2	2	2	1	1

Ref. 4995 - N° Art. 22624: 229,71 €



Display 39 - Ref. 1655

∅	26 L230	28 L230	30 L230	32 L230	10 L460	12 L460	14 L460	16 L460
Pcs	1	1	1	1	2	2	2	2

Ref. 4995 - N° Art. 22626: 298,23 €

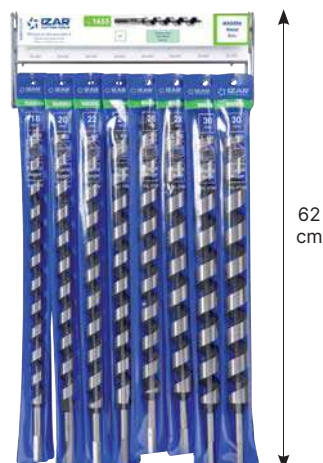

Display 40 - Ref. 1655

∅	18 L460	20 L460	22 L460	24 L460	26 L460	28 L460	30 L460	32 L460
Pcs	2	2	1	1	1	1	1	1

Ref. 4995 - N° Art. 22627: 406,97 €



Ref. **1644**

BROCA ENCOFRADO MADERA SDS PLUS

SDS PLUS WOOD Cavity Drill Bit
Foret coffrage BOIS SDS PLUS

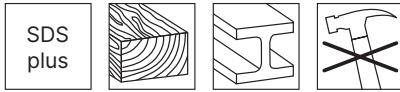

Aceros
Steel
Aciers

Madera
Wood
Bois

D mm	L mm	I mm		Nº Art.	€
10	400	87	1	15447	20,49
12	400	100	1	15450	22,05
14	400	100	1	15453	28,78
16	400	100	1	15460	36,35
18	400	100	1	15507	47,49
20	400	100	1	15576	52,48
22	400	100	1	15579	60,67
24	400	100	1	15582	77,26
26	400	100	1	15603	91,54
28	400	100	1	15621	98,33
30	400	100	1	15627	109,14

D mm	L mm	I mm		Nº Art.	€
10	600	87	1	15660	21,25
12	600	100	1	15669	23,70
14	600	100	1	15780	31,78
16	600	100	1	15781	39,30
18	600	100	1	15783	50,56
20	600	100	1	15784	55,51
22	600	100	1	15793	63,73
24	600	100	1	15799	80,27
26	600	100	1	15801	94,65
28	600	100	1	15807	101,37
30	600	100	1	15808	112,29



Línea 1 m - Ref. 1644 - L400



Ø	10 L400	12 L400	14 L400	16 L400	18 L400	20 L400	22 L400	24 L400	26 L400	28 L400	30 L400
Pcs	1	1	1	1	1	1	1	1	1	1	1

Ref. 4995 - Nº Art. 72174: **644,58 €**

Línea 1 m - Ref. 1644 - L600



Ø	10 L600	12 L600	14 L600	16 L600	18 L600	20 L600	22 L600	24 L600	26 L600	28 L600	30 L600
Pcs	1	1	1	1	1	1	1	1	1	1	1

Ref. 4995 - Nº Art. 72175: **674,41 €**



Ref. **1643**

BROCA ENCOFRADO MADERA

WOOD Cavity Drill Bit
Foret coffrage BOIS



Aceros
Steel
Aciers

Madera
Wood
Bois

D mm	L mm	l mm	d mm		Nº Art.	€
6	400	57	5	1	23988	10,57
8	400	75	6	1	23989	10,65
10	400	87	8	1	23990	12,48
12	400	100	8	1	23991	16,01
14	400	100	8	1	23992	19,19
16	400	100	10	1	23993	22,79
18	400	100	10	1	23994	30,01
20	400	100	10	1	23995	34,81
22	400	100	10	1	23996	46,59
24	400	100	11	1	23997	54,75
26	400	100	11	1	23999	62,97
28	400	100	11	1	24000	67,10
30	400	100	11	1	24001	75,03

D mm	L mm	l mm	d mm		Nº Art.	€
6	600	57	5	1	24002	11,33
8	600	75	6	1	24004	11,40
10	600	87	8	1	24005	13,31
12	600	100	8	1	24006	16,75
14	600	100	8	1	24007	20,14
16	600	100	10	1	24008	24,01
18	600	100	10	1	24009	31,73
20	600	100	10	1	24010	36,26
22	600	100	10	1	24011	49,09
24	600	100	11	1	24012	60,70
26	600	100	11	1	24013	65,54
28	600	100	11	1	24014	69,64
30	600	100	11	1	24015	78,54



Display 41 - Ref. 1643



53 cm

∅	6	8	10	12	14	16	18	20
	L400	L400	L400	L400	L400	L400	L400	L400
Pcs	2	2	2	2	2	2	2	2

Ref. 4995 - Nº Art. 22629: 313,02 €

Display 42 - Ref. 1643



71 cm

∅	6	8	10	12	14	16	18	20
	L600	L600	L600	L600	L600	L600	L600	L600
Pcs	2	2	2	2	2	2	2	2

Ref. 4995 - Nº Art. 22630: 329,86 €



Ref. **1692**

BROCA MADERA ESPIRAL SDS PLUS

SDS plus Wood Auger Bit
Foret bois spirale SDS plus

New!



Maderas Duras
Hard Wood
Bois dur

D mm	L mm	I mm		Nº Art.	€
6	230	160	1	79143	14,75
8	230	160	1	79183	15,57
10	230	160	1	79210	16,45
12	230	160	1	79224	17,09
14	230	160	1	79243	18,09
16	230	160	1	79245	20,75
18	230	160	1	79247	26,41
20	230	160	1	79259	30,02

D mm	L mm	I mm		Nº Art.	€
6	460	370	1	79266	17,73
8	460	370	1	79267	18,70
10	460	370	1	79268	20,36
12	460	370	1	79271	22,05
14	460	370	1	79285	27,00
16	460	370	1	79301	31,98
18	460	370	1	79303	42,80
20	460	370	1	79306	48,00
24	460	370	1	84081	57,88
26	460	370	1	84082	62,88



Ref. **1639**

AVELLANADOR MADERA

Shell Drill Bit

Foret outil-lamer-chambres Bois



HSS



También posible uso como **tope** para brocas
Also usable as a drill **stop**
Utilisable comme bague d'**arret** pour forets

D- mm	D+ mm		Nº Art.	€
3	16	1	56011	7,12
4	16	1	56012	7,12
5	16	1	56013	7,12
6	16	1	56014	7,12
8	20	1	56016	8,85
10	20	1	56018	8,85



Línea 33 cm - Ref. 1639



20
cm

∅	3×16	4×16	5×16	6×16	8×20	10×20
Pcs	2	2	2	2	2	2

Ref. 4995 - Nº Art. 72160: 92,36 €



FRESAS

Router Cutters

Fraises

Ref. **1685**

FRESA RANURADO Y COPIADO CON CENTRADOR

Straight Bit with Centre Tip
Fraise rainurage et copiage avec pointe



MD
HM
Carbure

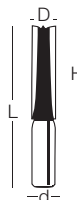
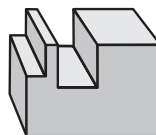

D mm	d mm	L mm	H mm		N° Art.	€
3,00	8,00	37,0	6	1	69222	20,98
4,00	8,00	41,0	10	1	69225	20,98
5,00	8,00	43,0	12	1	69228	22,56
6,00	8,00	48,0	14	1	69231	22,56

D mm	d mm	L mm	H mm		N° Art.	€
8,00	8,00	51,0	20	1	69234	23,42
10,00	8,00	50,0	20	1	69237	23,42
12,00	8,00	50,0	20	1	69240	25,12



Ref. **1669**

FRESA RANURADO Y COPIADO

Straight Bit
Fraise rainurage et copiage



MD
HM
Carbure

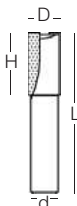
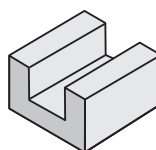

D mm	d mm	L mm	H mm		Z		N° Art.	€
3,00	8,00	47,0	11,0	1	1	36312	18,24	
4,00	8,00	47,0	11,0	1	1	36313	18,24	
5,00	8,00	47,0	11,0	1	1	36314	19,62	
6,00	8,00	48,0	16,0	2	1	36315	19,62	
8,00	8,00	51,0	20,0	2	1	36316	20,37	
10,00	8,00	51,0	20,0	2	1	36317	20,37	
12,00	8,00	51,0	20,0	2	1	36318	21,85	

D mm	d mm	L mm	H mm		Z		N° Art.	€
14,00	8,00	51,0	20,0	2	1	36319	23,45	
16,00	8,00	51,0	20,0	2	1	36320	25,25	
18,00	8,00	51,0	20,0	2	1	36321	26,20	
20,00	8,00	51,0	20,0	2	1	36322	28,44	
22,00	8,00	59,0	25,0	2	1	36323	29,56	
24,00	8,00	43,5	11,5	2	1	36324	30,34	



Ref. **1679**

FRESA REBAJADO CON COPIADOR

Rabbeting Bit
Fraise réduction avec copieur



MD
HM
Carbure

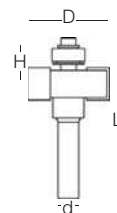
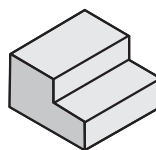

D mm	d mm	L mm	H mm		N° Art.	€
28,50	8,00	54,0	12,7	1	69279	35,33



Ref. **1678**

FRESA REFUNDIDO RECTO CON COPIADOR

Flush Trim Bit
Fraise fusionage droit avec copieur



MD
HM
Carbure

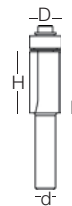
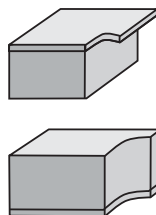

D mm	d mm	L mm	H mm		N° Art.	€
12,70	8,00	70,0	25,4	1	36343	27,71



Ref. **1674**

FRESA RANURAS EN "V"

"V" Grooves Bit
Fraise rainures "V"



MD
HM
Carbure

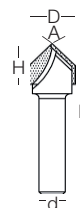
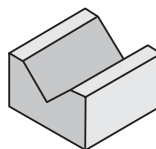

D mm	d mm	L mm	H mm	A		N° Art.	€
12,70	8,00	45,0	12,7	90°	1	60757	22,80
16,00	8,00	46,0	12,7	90°	1	69212	25,74
19,00	8,00	51,0	16,0	90°	1	69214	30,43



Ref. **1676**

FRESA COLA DE MILANO CON PRECORTADOR

Dovetail Bit
Fraise queue d'aronde avec precoupeur



MD
HM
Carbure

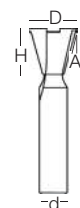
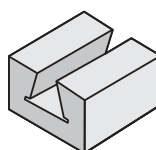

D mm	d mm	L mm	H mm	A		N° Art.	€
12,70	8,00	45,0	12	14°	1	60758	34,31



Ref. **1677**

FRESA BISELADO CON COPIADOR

Bevel Trim Bit
Fraise biseautage avec copieur



MD
HM
Carbure

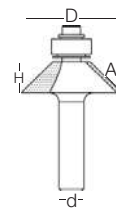
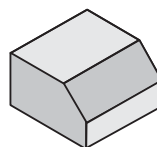

D mm	d mm	L mm	H mm	A		Nº Art.	€
31,80	8,00	56,0	15	45°	1	36356	32,16



Ref. **1670**

FRESA RADIO CÓNCAVO

Core Box Bit
Fraise rayon concave



MD
HM
Carbure

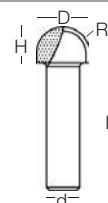
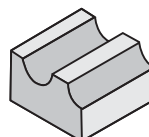

D mm	d mm	L mm	H mm	R		Nº Art.	€
9,50	8,00	40,0	9,5	4,8	1	36328	28,23
12,70	8,00	40,0	12,7	6,3	1	36329	30,14



Ref. **1671**

FRESA RADIO CÓNCAVO CON COPIADOR

Cove Bit
Fraise rayon concave avec copieur



MD
HM
Carbure

3 Z

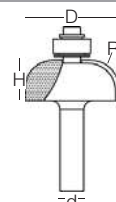
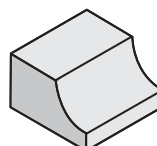

D mm	d mm	L mm	H mm	R		Nº Art.	€
28,50	8,00	55,0	14	9,5	1	60759	43,35
35,00	8,00	58,0	16	12,7	1	60760	51,44



Ref. **1672**

FRESA REDONDEADO CANTOS CON COPIADOR

Beading Bit
Fraise arrondir les bouts avec copieur



MD
HM
Carbure

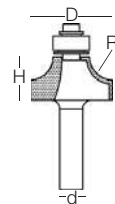
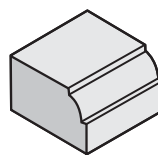

D mm	d mm	L mm	H mm	R		N° Art.	€
25,40	8,00	54,0	13,5	6,3	1	36332	47,39
28,60	8,00	55,0	15,9	7,9	1	36333	50,00
31,80	8,00	56,0	16,7	9,5	1	36334	53,81
38,10	8,00	59,0	19,0	12,7	1	36335	62,60



Ref. **1673**

FRESA REDONDEADO CANTOS CON COPIADOR

Round Over Bit
Fraise arrondir les bouts avec copieur



MD
HM
Carbure

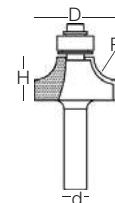
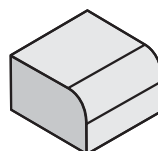

D mm	d mm	L mm	H mm	R		N° Art.	€
25,40	8,00	55,0	13,5	6,3	1	36336	47,39
28,60	8,00	56,0	15,9	7,9	1	36337	50,00
31,80	8,00	57,0	16,7	9,5	1	36338	53,81
38,10	8,00	60,0	19,0	12,7	1	36339	62,60



Ref. **1681**

FRESA PERFILADO CON COPIADOR

Roman Ogee Bit
Fraise profilage avec copieur



MD
HM
Carbure

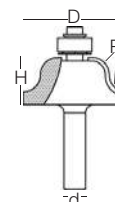
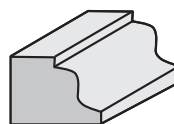

D mm	d mm	L mm	H mm	R		N° Art.	€
35,00	8,00	60,0	17,4	6,30	1	60762	67,36





Ref. **1682**

FRESA PERFILADO
Classical Roman Ogee Bit
Fraise profilage

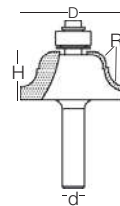
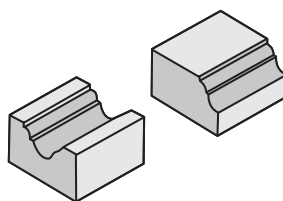

MD
HM
Carbure



D mm	d mm	L mm	H mm	R		N° Art.	€
35,00	8,00	56,0	15,9	4,80	1	60763	45,01





Ref. **1686**

FRESA PERFILADO
Ogee Bit
Fraise profilage

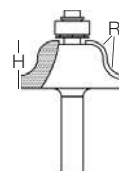
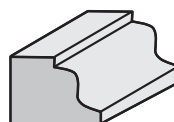

MD
HM
Carbure



D mm	d mm	L mm	H mm	R		N° Art.	€
31,80	8,00	54,0	12,7	4,8	1	69699	52,66
38,00	8,00	57,0	15,9	6,3	1	69701	60,18



Línea 1 m 16FM

FRESAS MADERA Wood Router Cutters Fraises Bois



Ref.	1669	1669	1669	1669	1669	1669	1669	1670	1670	1674	1674	1676	1677	1678	1679	1686	1681	1682	1685
∅	5	6	8	10	12	14	16	9,5	12,7	12,7	16	12,7	31,80	12,7	28,5	31,8	34,90	35	12
Pcs	1	1	1	1	1	1	1	1	1	1	1	1	1	1	1	1	1	1	1

Ref. 4995 - N° Art. 72181: 577,10 €

Display 64

FRESAS MADERA Wood Router Cutters Fraises Bois



Ref.	1669	1669	1669	1669	1669	1669
∅	5	6	8	10	12	14
Ref.	1669	1670	1670	1671	1671	1672
∅	16	9,50	12,70	28,50	35	28,60
Ref.	1672	1672	1673	1673	1673	1674
∅	31,80	38,10	28,60	31,80	38,10	12,70
Ref.	1674	1676	1677	1678	1679	1681
∅	16	12,70	31,80	12,70	28,50	34,90
Ref.	1686	1682	1685	1685	1685	1685
∅	31,80	35	6	8	10	12

N° Art. 39710: 1.074,11 €

Ref. **1615**

BROCA-FRESA INSTALADORES

TCT Hinge Boring Bit
Mèche à façonner installateurs



Diente MD
Carbide Tipped
Dent Carbure



RPM
Max.
800-1000

Maderas Duras
Hard Wood
Bois dur

Maderas Blandas
Soft Wood
Bois tendre

Indicado carpinteros y ebanistas, para instalación de ventanas, puertas y cocinas en todo tipo de maderas y materiales abrasivos.

Suitable for carpenters and cabinet-makers installing windows, doors & kitchens in all wood types and abrasive materials.

Idéal pour charpentiers et menuisiers pour installation de fenêtres, portes et cuisines tout genre de surfaces et matériaux abrasifs.

D mm	d mm	L mm	l mm		Nº Art.	€
15	8	90	10,00	1	23039	13,30
18	8	90	10,00	1	23040	15,80
20	8	90	12,50	1	23041	17,37
22	8	90	12,50	1	23042	18,96
24	8	90	12,50	1	23043	20,89
25	8	90	12,50	1	23044	21,78
26	8	90	14,50	1	23045	22,57
30	8	90	14,50	1	23046	24,76
35	10	90	14,50	1	23047	29,71
40	10	90	16,50	1	23048	33,81



Línea 33 cm - Ref. 1615



∅	20	25	26	35
Pcs	2	2	2	2

Ref. 4995 - Nº Art. 72183: 182,86 €



Ref. **1620**

BROCA-FRESA MADERA

WOOD Forstner Bit
Mèche a façonner BOIS



Maderas Duras
Hard Wood
Bois dur

Maderas Blandas
Soft Wood
Bois tendre

Apropiado para todo tipo de maderas naturales, blandas y nobles.

Ideal for use in all natural soft and hard woods.

Idéal pour tout genre de bois naturels, tendres et nobles.

D mm	d mm	L mm	l mm		N° Art.	€
10	9,50	93	8,50	1	18189	5,87
12	9,50	93	9,00	1	18190	6,06
14	9,50	93	9,00	1	18192	6,38
15	9,50	93	9,50	1	18193	6,48
16	9,50	93	9,50	1	18195	6,57
18	9,50	93	10,00	1	18196	7,85
20	9,50	93	10,50	1	18198	7,26
22	9,50	93	11,00	1	18199	8,26
24	9,50	93	11,50	1	18201	8,47
25	9,50	93	11,50	1	18202	8,59

D mm	d mm	L mm	l mm		N° Art.	€
26	9,50	93	11,50	1	18204	9,29
28	9,50	93	12,50	1	18205	8,05
30	9,50	93	13,00	1	18206	8,05
32	9,50	93	13,00	1	18207	10,57
34	9,50	93	13,50	1	18208	11,14
35	9,50	93	13,50	1	18210	11,52
40	9,50	95	15,50	1	18213	13,06
45	9,50	95	16,00	1	18214	14,68
50	9,50	95	17,50	1	18216	15,95



8 Pcs

Cont. Ø	N° Art.	€
15-20-25-30-35-40-45-50 mm	24630	85,58

Línea 33 cm - Ref. 1620



ø	16	20	26	35	40
Pcs	2	2	2	2	2

Ref. 4995 - N° Art. 72185: 95,40 €



Ref. **1625**

BROCA-FRESA BISAGRAS

Cantilever Hinge Bit
Mèche à façonner charnières



MD
HM
Carbure

D mm	d mm	L mm	l mm		Nº Art.	€
26	8	54	7,50	1	24476	20,52
30	8	54	8,00	1	24477	20,52
35	8	54	8,20	1	24478	21,00



Línea 33 cm - Ref. 1625



∅	26	30	35
Pcs	2	2	2

Ref. 4995 - Nº Art. 72187: 124,08 €



Ref. **1689**

FRESA ESPUMAS EVA* Y MADERA

EVA Foam & Wood End Mill
Fraise caoutchouc EVA et Bois



**MD
HM**
Carbure

IZAR
Std.

2
Dientes
Teeth/Dents

* **Etilvinilacetato**
Ethylene-vinyl acetate
Éthylène-acétate de vinyle

Espumas EVA
Foam
Caoutchouc

Madera
Wood
Bois

Plásticos
Plastics
Plastiques

D mm	d mm	L mm	l mm	Z		Nº Art.	€
1,00	3	38	3	2	1	79346	9,49
1,50	3	38	7	2	1	79421	9,49
2,00	3	38	17	2	1	79422	9,49
2,50	3	38	17	2	1	79423	9,49
3,00	3	55	32	2	1	79435	10,70
4,00	4	65	42	2	1	79436	20,05
6,00	6	70	42	2	1	79437	26,38
8,00	8	75	42	2	1	79438	41,20
10,00	10	85	42	2	1	79440	78,51



- **Geometría Multi Material válida para una amplia gama de productos como espumas, acrílicos, PVC, ABS, tableros, madera contrachapada, resinas, nylon, etc.**
- **Special Multi Material geometry suitable for a wide range of products such as foams, acrylic, PVC, ABS, hardwood, plywood, resins, nylon, etc.**
- **Géométrie Multi Matériaux pour une gamme large de produits comme mousses, acryliques, PVC, ABC, tableaux, bois contreplaqués, résines, nylon, etc.**
- **Mecanizado de las bandejas de herramientas.**
- **Machining of tool trays.**
- **Usinage de plateaux d'outils.**



Ref. **7009**

BROCA-FRESA ROTOZIP® / ROTOCUT® CERÁMICAS

Ceramic Rotozip® / Rotocut® Cutout Bit
Foret-Fraise Rotozip® / Rotocut® Céramique



Argamasa, Azulejos Cerámica, Estuco,
Mármol, Placas Cemento, Yeso

Concrete Panels, Ceramic Tiles, Marble,
Mortar, Plaster, Stucco

Mortier, Carreaux Faïence Céramique,
Stuc, Marbre, Plaques de ciment, Plâtre

D mm	Pulgadas Inches / Pouces	L	I	 N° Art.	€
3,18	1/8	45,00	21,00	1 18933	17,90
6,35	1/4	50,00	20,50	1 18939	30,01



Ref. **7002**

BROCA-FRESA ROTOZIP® / ROTOCUT® ESCAYOLA

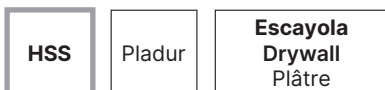

Drywall Rotozip® / Rotocut® Cutout Bit
Foret-Fraise Rotozip® / Rotocut® Plâtre



Escayola, Muros Prefabricados

Drywall, Prefabricated Walls

Plâtre, Murs Préfabriqués

D mm	Pulgadas Inches / Pouces	L	I	 Z  N° Art.	€
3,18	1/8	58,00	35,00	3 2 18927	4,47

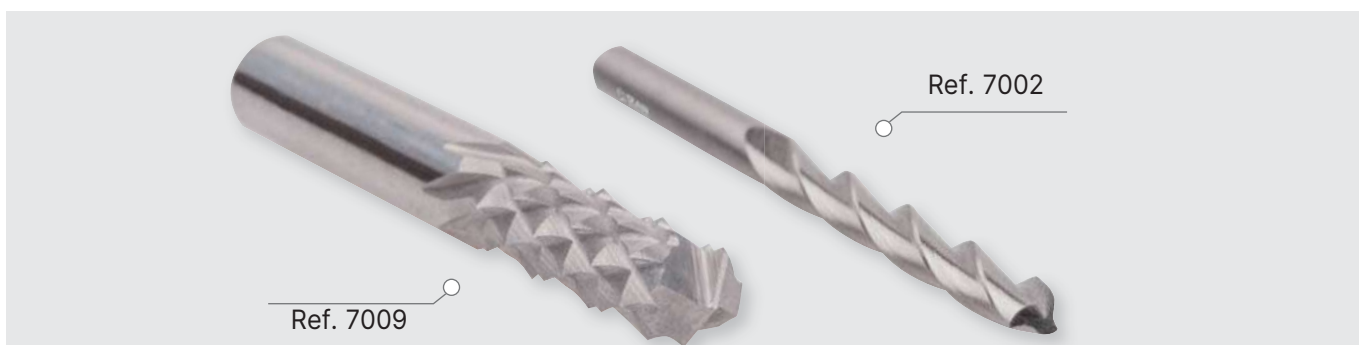

Ref. **7003**

BROCA-FRESA ROTOZIP® / ROTOCUT® AUTO-GUÍA

Autocenter Rotozip® / Rotocut® Cutout Bit
Foret-Fraise Rotozip® / Rotocut® autocentré



HSS

Auto-center

Escayola, Espuma, Muros Prefabricados

Drywall, Foam, Prefabricated Walls

Plâtre, Mousse, Murs Préfabriqués

D mm	Pulgadas Inches / Pouces	L	I	Z	Art.	Nº Art.	€
3,18	1/8	60,00	35,00	1	2	19002	4,47
3,97	5/32	75,00	40,00	1	2	67795	5,74
6,35	1/4	82,00	44,00	1	1	18930	10,00



Ref. **7001**

BROCA-FRESA ROTOZIP® / ROTOCUT® MADERA

Wood Rotozip® / Rotocut® Cutout Bit
Foret-Fraise Rotozip® / Rotocut® Bois



HSS



Aglomerado, Aluminio, Espuma, Fibra Vidrio, Laminados, Plástico, Plexiglas, Vinilo

Aluminium, Chipboard, FibreGlass, Foam, Laminated, Plastics, Plexiglas, Vinyl

Agglomérat, Aluminium, Mousse, Fibre de Verre, Laminés, Plastiques, Plexiglas, Vinyle

D mm	Pulgadas Inches / Pouces	L	I	Z	Art.	Nº Art.	€
3,18	1/8	70,00	35,00	1	2	18999	4,47



Ref. 7003

Ref. 7001



Ref. **1690**

CUCHILLA CEPILLOS ELÉCTRICOS

Planner Blade
Lame à surfacer

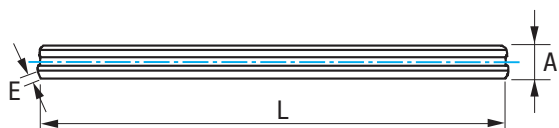

L	A	E		Nº	€
mm	mm	mm		Art.	
82	5,5	1,10	2	60635	3,90 *



* € = 1 ud.



04.HEX

ATORNILLADORES DE IMPACTO

Impact Drivers

Visseuses impact

METAL

Metal
Métal

328

CONSTRUCCIÓN

Construction
Construction

340

MADERA

Wood
Bois

345

OTROS

Others
Autres

352



▶ Video

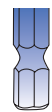

New!

Ref.
1616

BROCA MANGO E6.3 COBALTO

Cobalt E6.3 Shank Drill Bit
Foret queue E6.3 Cobalt



Ref. **1616**

BROCA MANGO E6.3 COBALTO

Cobalt E6.3 Shank Drill Bit
Foret queue E6.3 Cobalt



New!



HSSE 5% Co							Ambar Gold Finish Finition Or	Rectificado Ground Taillé meulé	Materiales Duros Hard Materials Matériaux durs
-------------------	--	--	--	--	--	--	---	---	---

Aceros <1300 N/mm² Steel / Aciers	INOX Ferríticos-Martensíticos Ferritic-Martensitic Stainless INOX Ferritiques-Martensitiques	Titanio Titanium Titane	1 sola pieza solid piece seule pièce
---	---	--------------------------------------	---

- **Fabricada en una sola pieza:** soporta adecuadamente el par de torsión que liberan los atornilladores de impacto más potentes
- **Fabricada con las mismas exigencias de calidad** que el resto de nuestras brocas
- **Produced in 1 solid piece:** It can stand properly the large torque of the impact drivers
- **Manufactured with the same high quality standards** as in the rest of our drill bits
- **Fabriqué en une seule pièce :** Il supporte adéquatement le couple de torsion libéré par les visseuses Impact les plus puissantes
- **Fabriqué avec la même exigence** que le reste de nos forets

D mm	L mm	I mm	d mm		Nº Art.	€
2,00	68	24	6,35	1	23094	9,96
2,50	68	24	6,35	1	23097	9,96
3,00	68	24	6,35	1	23099	8,77
3,30	70	39	6,35	1	23103	8,77
3,50	70	39	6,35	1	23107	8,77
4,00	75	43	6,35	1	23111	7,52
4,20	75	43	6,35	1	23114	7,52
4,50	80	47	6,35	1	23120	7,52
5,00	86	52	6,35	1	23123	7,11
5,50	93	57	6,35	1	23125	7,11
6,00	93	57	6,35	1	23129	6,54
6,50	101	63	6,35	1	23131	6,54

D mm	L mm	I mm	d mm		Nº Art.	€
7,00	109	69	6,35	1	23149	6,54
7,50	109	69	6,35	1	23151	7,36
8,00	117	75	6,35	1	23153	8,46
8,50	117	75	6,35	1	23155	9,29
9,00	125	81	6,35	1	23157	10,13
9,50	125	81	6,35	1	23159	11,19
10,00	133	87	6,35	1	23161	12,29
10,50	133	87	6,35	1	23163	13,82
11,00	142	94	6,35	1	23165	16,09
11,50	142	94	6,35	1	23167	17,27
12,00	151	101	6,35	1	23169	19,17
12,50	151	101	6,35	1	23171	21,04
13,00	151	101	6,35	1	23173	21,85



Set 5 Pcs

Cont. Ø	Nº Art.	€
3-4-5-6-8 mm	35267	38,40



Set 8 Pcs

Cont. Ø	Nº Art.	€
3-4-5-6-7-8-9-10 mm	35268	67,36

Display 74



Ø	2	3	4	4,5	5	6	7	8	9	10
Pcs	5	5	5	5	5	5	3	3	3	3

Ref. 4995 - Nº Art. 84044: 349,36 €



Ref. **1613**

BROCA MANGO E6.3 HSS

HSS E6.3 Shank Drill Bit
Foret queue E6.3 HSS



New!



HSS							Std + Imp. Driver	Blanca Bright Finish Finition blanche	Rectificado Ground Taillé meulé	Usos General General Purpose Utilisation générale
-----	--	--	--	--	--	--	-------------------	---	---------------------------------------	---

Aceros <850 N/mm ² Steel / Aciers	Fundición Cast Iron Fonte	Aluminio Aluminium
---	--	------------------------------

1 sola pieza
solid piece
seule pièce

- Fabricada en una sola pieza:** soporta adecuadamente el par de torsión que liberan los atornilladores de impacto más potentes
- Fabricada con las mismas exigencias de calidad** que el resto de nuestras brocas
- Produced in 1 solid piece:** It can stand properly the large torque of the impact drivers
- Manufactured with the same high quality standards** as in the rest of our drill bits
- Fabriqué en une seule pièce :** Il supporte adéquatement le couple de torsion libéré par les visseuses Impact les plus puissantes
- Fabriqué avec la même exigence** que le reste de nos forets

D mm	L mm	I mm	d mm		Nº Art.	€
2,00	68	24	6,35	1	23093	7,14
2,50	68	24	6,35	1	23096	7,14
3,00	68	24	6,35	1	23098	6,25
3,30	70	39	6,35	1	23100	6,25
3,50	70	39	6,35	1	23106	6,25
4,00	75	43	6,35	1	23109	5,41
4,20	75	43	6,35	1	23113	5,41
4,50	80	47	6,35	1	23115	5,41
5,00	86	52	6,35	1	23121	5,57
5,50	93	57	6,35	1	23124	5,57
6,00	93	57	6,35	1	23127	5,14
6,50	101	63	6,35	1	23130	5,14

D mm	L mm	I mm	d mm		Nº Art.	€
7,00	109	69	6,35	1	23148	5,14
7,50	109	69	6,35	1	23150	5,77
8,00	117	75	6,35	1	23152	6,63
8,50	117	75	6,35	1	23154	6,63
9,00	125	81	6,35	1	23156	7,23
9,50	125	81	6,35	1	23158	8,00
10,00	133	87	6,35	1	23160	8,79
10,50	133	87	6,35	1	23162	9,88
11,00	142	94	6,35	1	23164	11,50
11,50	142	94	6,35	1	23166	12,35
12,00	151	101	6,35	1	23168	13,71
12,50	151	101	6,35	1	23170	15,05
13,00	151	101	6,35	1	23172	15,63



Set 5 Pcs

Cont. Ø	Nº Art.	€
3-4-5-6-8 mm	35269	29,00



Set 8 Pcs

Cont. Ø	Nº Art.	€
3-4-5-6-7-8-9-10 mm	35270	50,16

Display 75



Ø	2	3	4	4,5	5	6	7	8	9	10
Pcs	5	5	5	5	5	5	3	3	3	3

Ref. 4995 - Nº Art. 84048: 257,97 €



Ref. **1611**

BROCA MANGO E6.3 EXTRA CORTA

E6.3 Shank Stub drill Bit
Foret queue E6.3 extra-courte

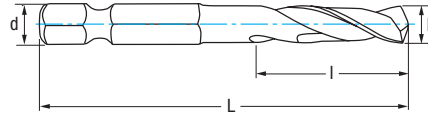

D mm	L mm	l mm	d mm		Nº Art.	€
2,00	47	16	6,35	1	56512	3,49
3,00	47	16	6,35	1	15864	3,49
3,20	47	16	6,35	1	56515	3,49
3,25	47	16	6,35	1	15865	3,49
3,50	47	16	6,35	1	15892	3,24
4,00	53	20	6,35	1	15894	3,24
4,20	53	20	6,35	1	56516	3,24
4,25	53	20	6,35	1	15898	3,24
4,50	53	20	6,35	1	15899	3,07
5,00	59	26	6,35	1	15900	3,07
5,50	59	26	6,35	1	15902	3,06
6,00	59	26	6,35	1	15903	3,06
6,50	59	26	6,35	1	15904	3,06
7,00	59	26	6,35	1	15905	3,76
8,00	59	32	6,35	1	15906	3,76



Línea 33 cm - Ref. 1611



ø	3	4	5	6	8
Pcs	5	5	5	5	5

Ref. 4995 - Nº Art. 72198: **83,10 €**

Ref. **1461**

SET BROCAS MANGO HEXAGONAL 1/4" Y PUNTAS DE ATORNILLAR

Hexagonal Shank Drill Bit and Screwdriver Bit Set
Jeu de forets hexagonales et embouts vissage



Set 17 Pcs

Nº Art.	€
82204	21,35

Brocas Metal
Metal Drill Bits
Forets Métal
3- 4 - 5 - 6 mm

d mm: 6,35
Tx
T10
T15
T20
T25
T30
T40
±25 mm→

PH d mm: 6,35
PH1
PH2
PH3
±25 mm→

Adapt. Quick-Lock
INOX/Stainless
L mm: 60 - d mm: 6,35

PZ d mm: 6,35
PZ1
PZ2
PZ3
±25 mm→

6 Sets

Nº Art.	€
19322	121,70



New!

Ref.
1622

BROCA ESCALONADA ESPIRAL MANGO E6.3

E6.3 Shank Spiral Step Drill Bit
Foret étagé spirale queue E6.3



Ref. **1622**

BROCA ESCALONADA ESPIRAL MANGO E6.3

E6.3 Shank Spiral Step Drill Bit
Foret étagé spirale queue E6.3



New!

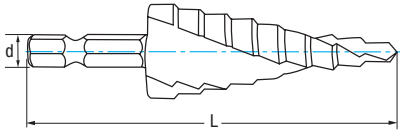

**HSSE
5% Co**

IZAR
Std.

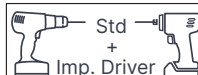

**Aceros
<850 N/mm²
Steel / Aciers**

**INOX
Stainless Steel
Acier INOX**

**Cobre
Copper
Cuivre**

**Aluminio
Aluminium**

**Termoplásticos
Thermoplastics
Thermoplastiques**

- Punta robusta autocentrante
- Avellanado especial 45°
- Menor desgaste y esfuerzo de corte
- Mayor rendimiento y vida útil de la herramienta
- Mejor evacuación de viruta
- Acabado sin rebabas

- Autocentering robust point
- Special 45° Countersinking
- Lower wear and cutting effort
- Better performance & longer tool life
- Better chipping-off
- No-burr finishing

- Pointe plus robuste autocentrante
- Ébavurage special à 45°
- Réduction de l'usure et de l'effort de coupe
- Augmentation de la performance et vie utile de l'outil
- Meilleure évacuation des copeaux
- Finition sans bavures

Cap. mm	Nº Pasos Steps / Étages	L mm	d mm	Nº Art.	€
4-12	9 (4-5-6-7-8-9-10-11-12)	70	6,35	59000	25,16
4-20	9 (4-6-8-10-12-14-16-18-20)	77	6,35	59003	31,98
6-30	13 (6-8-10-12-14-16-18-20-22-24-26-28-30)	98	6,35	59006	47,02



Línea 33 cm - Ref. 1622



∅	4-12	4-20	6-30
Pcs	2	2	2

Ref. 4995 - Nº Art. 84051: 208,32 €

Display 79 - Refs. 1622 - 1635



∅	Ref. 1622				Ref. 1635			
	4-12	4-20	6-30	6-30	12	12	16	19
Pcs	3	3	3	3	3	3	3	3

Ref. 4995 - Nº Art. 85252: 416,14 €



Ref. **3610**

MACHO RECTO MÉTRICA MANGO E6.3

E6.3 Shank Metric Straight Tap
Taraud droit métrique queue E6.3

New!

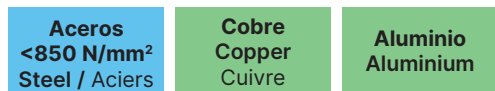
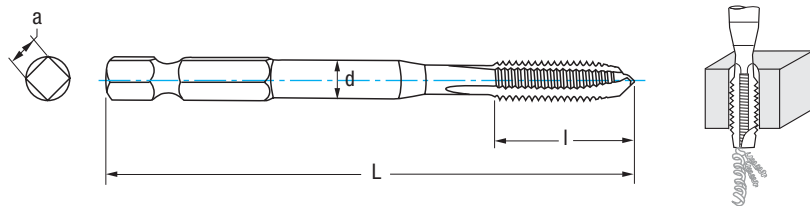

M	P	L mm	l mm	d mm	a mm		Nº Art.	€
M3	0,50	56	11	3,50	6,35	1	26706	10,93
M4	0,70	63	13	4,50	6,35	1	26708	10,93
M5	0,80	70	16	6,00	6,35	1	26717	10,93
M6	1,00	80	19	6,00	6,35	1	26718	12,75
M8	1,25	90	22	8,00	6,35	1	26719	14,43
M10	1,50	100	24	10,00	6,35	1	26720	18,21
M12	1,75	110	29	9,00	6,35	1	26721	21,15



Línea 33 cm - Ref. 3610



∅	M3	M5	M6	M8	M10
Pcs	3	3	3	3	3

Ref. 4995 - Nº Art. 84054: **201,75 €**

Display 78 - Refs. 3610 - 3650



∅	Ref. 3610					Ref. 3650				
	M3	M5	M6	M8	M10	M3	M5	M6	M8	M10
Pcs	3	3	3	3	3	3	3	3	3	3

Ref. 4995 - Nº Art. 85251: **439,74 €**



Ref. **3650**

MACHO HELICOIDAL MÉTRICA MANGO E6.3

E6.3 Shank Metric Spiral Tap
Taraud Hélicoïdal métrique queue E6.3

New!

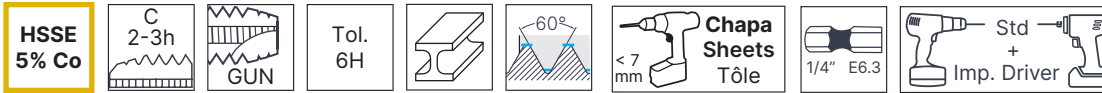
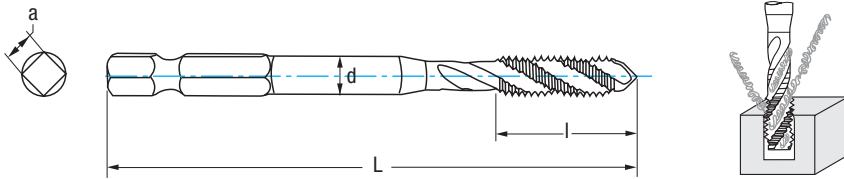

Aceros
<850 N/mm²
Steel / Aciers

Cobre
Copper
Cuivre

Aluminio
Aluminium

- Para roscado a mano no se recomiendan profundidades >7 mm, dado que la vibración podría causar roturas de los machos
- When threading by hand, not recommended for depths >7 mm, as the vibration could break the tap
- Pour le taraudage à main, il est déconseillé d'aller au-delà de 7 mm de profondeur, car les vibrations pourraient causer des ruptures des tarauds

M	P	L mm	l mm	d mm	a mm		N° Art.	€
M3	0,50	56	11	3,50	6,35	1	26723	13,51
M4	0,70	63	13	4,50	6,35	1	26725	13,51
M5	0,80	70	16	6,00	6,35	1	26726	13,51
M6	1,00	80	19	6,00	6,35	1	26727	13,82
M8	1,25	90	22	8,00	6,35	1	26728	16,86
M10	1,50	100	24	10,00	6,35	1	26730	21,63
M12	1,75	110	29	9,00	6,35	1	26731	24,64



Línea 33 cm - Ref. 3650



∅	M3	M5	M6	M8	M10
Pcs	3	3	3	3	3

Ref. 4995 - N° Art. 84057: 237,99 €



Ref. **1614**

BROCA-MACHO-AVELLANADOR MANGO E6.3

E6.3 Shank Combi Tap with Countersink
Outil multi-fonction queue E6.3



New!

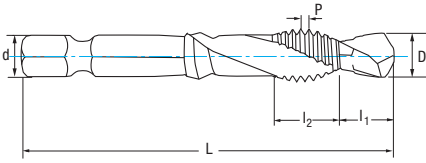

Aceros
<850 N/mm²
Steel / Aciers

Aluminio
Aluminium

D mm	P	L mm	l1 mm	l2 mm	d mm	Avellanado Countersinking Fraisage mm		Nº Art.	€
M3	0,50	52	8,10	8,90	6,35	7,20	1	53437	18,95
M4	0,70	52	8,60	8,90	6,35	7,20	1	53449	18,95
M5	0,80	56	8,90	11,90	6,35	7,20	1	53458	21,35
M6	1,00	56	8,90	11,90	6,35	7,20	1	53463	21,95
M8	1,25	57	8,90	11,90	6,35	9,10	1	53466	29,72
M10	1,50	58	9,60	14,00	6,35	10,80	1	53469	35,92
M12	1,75	69	12,70	14,00	6,35	12,80	1	53472	38,56



6 Sets

Nº Art. €
84155 **1.056,78**



Set 7 Pcs

Cont.	Nº Art.	€
M3-M4- M5-M6- M8-M10- M12	84151	185,40

Línea 33 cm - Ref. 1614

∅	3	4	5	6	8
Pcs	3	3	3	3	3

Ref. 4995 - Nº Art. 84060: **332,76 €**



- **3 funciones en 1: Taladrado, Roscado, Avellanado**
- **Roscas limpias y precisas**
- **3 fonctions in 1: Drilling, threading, Countersinking**
- **Clean and accurate threads**
- **3 fonctions en 1 : Perçage, taraudage, fraisage**
- **Filetages propres et précis**



Ref. **1635**

AVELLANADOR 5Z MANGO E6.3

E6.3 Shank 5Z Countersink
Fraise à noyer 5Z queue E6.3

New!

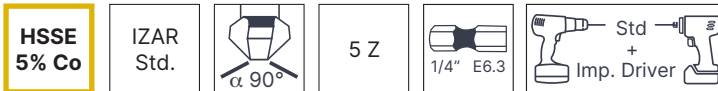
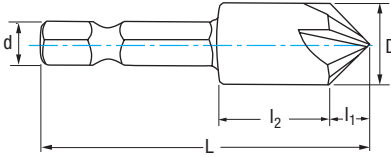

Aceros <850 N/mm ² Steel / Aciers	INOX Stainless Steel Acier INOX	Cobre Copper Cuivre	Aluminio Aluminium	Termoplásticos Thermoplastics Thermoplastiques	Madera Wood Bois
---	--	----------------------------------	------------------------------	---	-------------------------------

- Mecanizado silencioso gracias a los 5 filos de corte
- Poca vibración y acabado excelente
- High number of cutting edges allows a quiet cutting performance
- Chatter-free cutting performance. Excellent surface finishing
- Usinage silencieux grâce aux 5 arêtes de coupe
- Vibration réduite, performance de coupe sans bavardage. Excellente finition de surface

D mm	L mm	l1 mm	l2 mm	d mm	N° Art.	€
12,00	48,50	6,00	16,50	6,35	59009	11,07
16,00	49,50	8,00	15,50	6,35	59012	14,07
19,00	50,00	9,50	14,50	6,35	59015	20,68



Línea 33 cm - Ref. 1635

18 cm		∅	12	16	19
		Pcs	2	2	2

Ref. 4995 - N° Art. 84063: **91,64 €**

Display 76 - Refs. 3610 - 1635 - 1622 - 1614 - 1616



		Ref. 3610					Ref. 1635				
∅		M3	M5	M6	M8	M10	12	16	19		
Pcs		1	1	1	1	1	1	1	1		
		Ref. 1622			Ref. 1614						
∅		4-12	4-20	6-30	M3	M4	M5	M6	M8		
Pcs		1	1	1	2	2	2	2	2		
		Ref. 1616									
∅		2	3	4	4,50	5	6	7	8	9	10
Pcs		5	5	5	5	5	5	3	3	3	3

Ref. 4995 - N° Art. 85249: **788,43 €**



Ref. **8352**

REBARBADOR EXTERIOR

External Chamfer Tool
Outil de chanfrein externe

New!

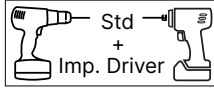
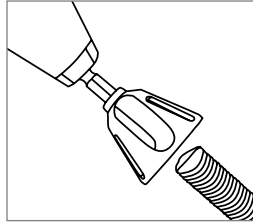

Aceros
<850 N/mm²
Steel / Aciers

Fundición
Cast Iron
Fonte

Cobre
Copper
Cuivre

Latón
Brass
Laiton

Aluminio
Aluminium

Cap.	Nº Art.	€
Ø 6 - 25 mm	25381	16,70

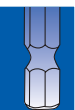

New!

Ref.
1839

BROCA-CORONA DIAMANTE PORCELÁNICO MANGO E6.3

E6.3 Shank Porcelain Diamond Core Bit

Foret-Trépan diamant porcelaine queue E6.3



Ref. **1839**

BROCA-CORONA DIAMANTE PORCELÁNICO MANGO E6.3

E6.3 Shank Porcelain Diamond Core Bit
Foret-Trépan diamant porcelaine queue E6



New!

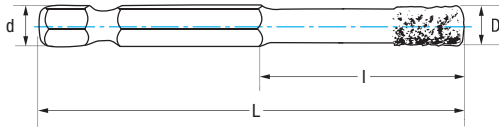

H₂O
Refrigerar punta
Point Cooling
Refrroidir la pointe

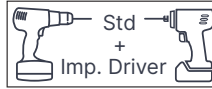

Uso / Use / Usage

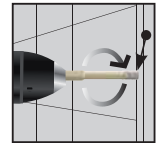
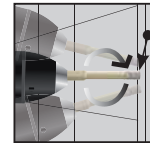
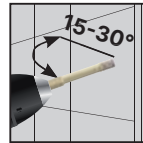

Porcelánico
Porcelain
Porcelaine

Cerámica
Ceramics
Céramique

- Grano de diamante fino adecuado para materiales duros
- Fine grit size of the diamond, suitable for hard materials
- Grain de diamant fin adapté aux matériaux durs
- Incluye un relleno especial de cera que se va disolviendo en el taladrado, ayudando en la refrigeración
- The special wax filled core aids cooling and lubrication
- Includ un remplissage spécial de cire qui se dissout pendant le perçage, aidant au refroidissement

D mm	L mm	I mm	d mm		Nº Art.	€
5,00	67	10	6,35	1	31564	17,06
6,00	67	10	6,35	1	31565	17,85
8,00	80	10	6,35	1	31566	22,13
10,00	80	10	6,35	1	31567	26,79
12,00	80	10	6,35	1	31568	29,63



Línea 33 cm - Ref. 1839

22 cm		∅	5	6	8	10	12
		Pcs	3	3	3	3	3

Ref. 4995 - Nº Art. 84066: 340,38 €

Display 77 - Refs. 1834 - 1601 - 1839 - 1834 - 1613



		Ref. 1834			Ref. 1601						
∅		8	10	12	4	5	6	8	10		
Pcs		5	2	2	5	5	3	3	3		
		Ref. 1839				Ref. 1834					
∅		5	6	6	8	10	12	5	6		
Pcs		3	3	3	3	3	3	5	5		
		Ref. 1613									
∅		2	3	4	4,50	5	6	7	8	9	10
Pcs		3	3	3	3	3	3	1	1	1	1

Ref. 4995 - Nº Art. 85250: 721,39 €



New!

Ref.

1834

BROCA VIDRIO Y AZULEJO 4Z+
4Z+ Glass and Soft Tiles Drill Bit
Foret verre et carreau 4Z+



Ref. **1834**

BROCA VIDRIO Y AZULEJO 4Z+

4Z+ Glass and Soft Tiles Drill Bit
Foret verre et carreau 4Z+



New!

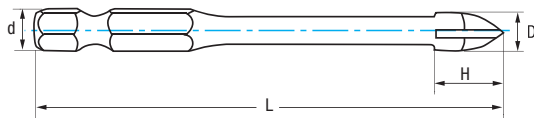

MD/HM TCT					4 Z		
--------------	--	--	--	--	-----	--	--

Vidrio Glass Verre	Cerámica Ceramics Céramique	Porcelánico Blando Soft Porcelain Porcelaine tendre
---------------------------------	--	--

- Punta metal duro con un afilado exclusivo IZAR
- Perforación con precisión debido a la geometría de la punta
- Sus 4 filos de corte permiten una rápida perforación
- Carbide tip with an exclusive IZAR sharpness
- Precision drilling due to the tip's geometry
- Its 4 cutting edges allow for fast drilling
- Pointe en carbure avec un affûtage exclusif IZAR
- Perçage précis grâce à la géométrie de la pointe
- Ses 4 arêtes de coupe permettent un perçage rapide

D mm	d mm	L mm	H mm		Nº Art.	€
5	6,35	75	9,50	1	31873	7,60
6	6,35	75	10,50	1	31992	8,06
8	6,35	85	12,50	1	32075	9,87
10	6,35	85	14,50	1	32099	13,82
12	6,35	90	16,50	1	32117	16,58



6 Sets

Nº Art.	€
69405	318,80



Set 5 Pcs

D mm	Nº Art.	€
5, 6, 8, 10, 12	69403	55,93

Línea 33 cm - Ref. 1834



∅	5	6	8	10	12
Pcs	5	5	5	5	5

Ref. 4995 - Nº Art. 84069: **279,65 €**



Ref. **1601**

BROCA PUNTA METAL DURO PARED

Masonry Carbide Tipped Drill Bit
Foret pointe carbure maçonnerie

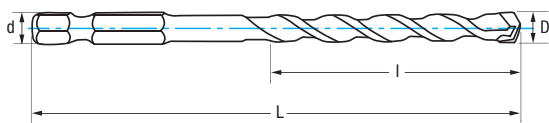

D mm	L mm	l mm	d mm		Nº Art.	€
4,00	90	45	6,35	1	55997	2,50
5,00	100	50	6,35	1	55998	2,65
6,00	100	50	6,35	1	55999	2,85
8,00	120	60	6,35	1	56000	3,79
10,00	120	60	6,35	1	56001	4,78



Línea 33 cm - Ref. 1601



ø	4	5	6	8	10
Pcs	5	5	5	5	5

Ref. 4995 - Nº Art. 72200: **82,85 €**



4 Pcs

Cont. Ø	Nº Art.	€
4-5-6-8 mm	59081	11,79

Ref. **1461**

SET BROCAS METAL-PARED-MADERA

Metal-Masonry-Wood Drill Bits Set
Jeu de forets métal-maçonnerie-bois



42
pcs



Brocas rectificadas metal Metal Ground Drill Bits Forets rectifiés métal 2 - 2,5 - 3 - 3,5 - 4 - 5 - 6 mm	Brocas pared Masonry Drill Bits Forets maçonnerie 4 - 5 - 6 - 8 mm	Brocas madera Wood Drill Bits Forets bois 3 - 4 - 5 - 6 - 8 mm
Nº Art. € 79873 70,51	Adapt. Quick-Lock INOX / Stainless L mm: 60 - d mm: 6,35 1 pc.	Cuter Hoja Partible Snap-Off Box Cutter Couteaux à lames rétractables 1 pc.

Puntas atornillar / Screwdriver Bits / Embouts vissage

PH PH1 PH2 PH3 ↳25 mm↳	Tx T10 T15 T20 T25 T27 T30 T40 ↳25 mm↳	SL SL 4 SL 5,5 SL 6,5 ↳25 mm↳
PZ PZ1 PZ2 PZ3 ↳25 mm↳	Ts TS15 TS20 TS25 TS30 TS40 ↳25 mm↳	
HEX H3 H4 H5 ↳25 mm↳		



New!



Ref.
1654

BROCA ESPIRAL 3Z TORNILLO EN PUNTA MANGO E6.3

3Z Screw-Point E6.3 Shank Auger Bit

Foret spirale 3Z vis en pointe queue E6.3



Ref. **1654**

BROCA ESPIRAL 3Z TORNILLO EN PUNTA MANGO E6.3

3Z Screw-Point E6.3 Shank Auger Bit
Foret spirale 3Z vis en pointe queue E6.3



New!

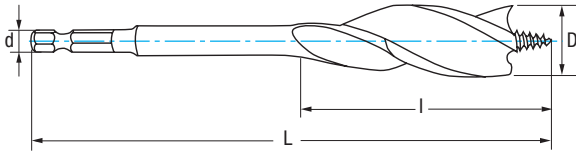

Maderas Duras
Hard Wood
Bois dur

- Gran rendimiento
- Rápido taladrado
- High performance
- Fast drilling
- Haut rendement
- Perçage rapide

D mm	L mm	l mm	d mm		Nº Art.	€
13,00	159	55	6,35	1	58512	7,09
16,00	159	64	6,35	1	58530	8,48
18,00	159	68	6,35	1	58539	9,15
20,00	159	76	6,35	1	58548	10,27
22,00	159	80	6,35	1	58557	10,94
25,00	159	86	6,35	1	58575	13,23
32,00	159	86	6,35	1	58647	17,63



Línea 33 cm - Ref. 1654



∅	16	18	20	22	25
Pcs	5	5	5	5	5

Ref. 4995 - Nº Art. 84072: 260,35 €

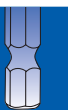

Ref. **1651**

BROCA PLANA GRAN RENDIMIENTO

Heavy Duty Flat Bit

Mèche plate haut rendement

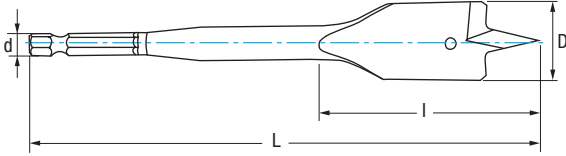

Maderas blandas
Soft Wood
Bois tendre



Set 8 Pcs

D mm	L mm	I mm	d mm		Nº Art.	€
6,00	152	38	6,35	1	56019	2,68
8,00	152	38	6,35	1	56021	2,68
10,00	152	38	6,35	1	56022	2,83
12,00	152	42	6,35	1	56023	3,11
13,00	152	42	6,35	1	56024	3,11
14,00	152	42	6,35	1	56025	3,24
16,00	152	42	6,35	1	56026	3,24
18,00	152	42	6,35	1	56028	3,99
19,00	152	42	6,35	1	56029	3,99
20,00	152	42	6,35	1	56030	3,99

D mm	L mm	I mm	d mm		Nº Art.	€
22,00	152	42	6,35	1	56031	3,99
24,00	152	46	6,35	1	56032	4,97
25,00	152	46	6,35	1	56033	4,97
26,00	152	46	6,35	1	56034	4,97
28,00	152	46	6,35	1	56035	6,38
30,00	152	46	6,35	1	56036	6,73
32,00	152	46	6,35	1	56037	6,73
35,00	152	46	6,35	1	56038	7,78
38,00	152	46	6,35	1	56040	8,82
40,00	152	46	6,35	1	56042	8,88

Cont. Ø	Nº Art.	€
12-16-18-20- 22-25-28-32 mm	57449	36,40

• Agujeros limpios.

• Very clean holes.

• Des trous propres.



Línea 1 m - Ref. 1651



∅	6	8	10	12	14	16	18	20	22	24	25	26	28	30	32	35	38	L305
Pcs	8	8	8	8	8	8	8	8	5	5	5	5	5	5	5	5	5	1

Ref. 4995 - N° Art. 72169: 493,68 €

Display 56 - Ref. 1651



∅	10	12	14	16	18	20
Pcs	10	10	10	10	10	10

Ref. 4995 - N° Art. 70078: 204,00 €

Display 57 - Ref. 1651



∅	22	24	25	26	28	30
Pcs	5	5	5	5	5	5

Ref. 4995 - N° Art. 70084: 160,05 €

Ref. **1653**

ALARGADOR

Extension
Rallonge



L mm	d mm	D mm		N° Art.	€
305	6,35	15,85	1	23982	10,90



Ref. **1650**

BROCA PLANA

Flat Bit
Mèche plate



Pala
Flat
Plate



Maderas Blandas
Soft Wood
Bois tendre

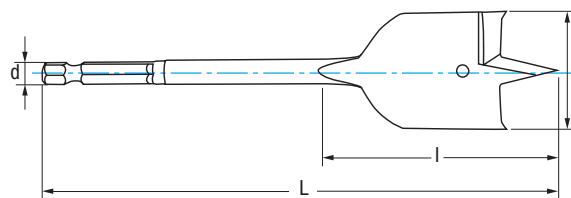

Larga / Long / Longue

D mm	L mm	I mm	d mm	📦	Nº Art.	€
6	152	38	6,35	1	30384	1,62
8	152	38	6,35	1	30385	1,62
10	152	38	6,35	1	30386	1,71
12	152	42	6,35	1	30387	1,88
13	152	42	6,35	1	55988	1,93
14	152	42	6,35	1	18457	1,96
16	152	42	6,35	1	18459	2,15
17	152	42	6,35	1	55989	2,29
18	152	42	6,35	1	18460	2,42
19	152	42	6,35	1	55990	2,42
20	152	42	6,35	1	18462	2,42
22	152	42	6,35	1	18463	2,81
24	152	46	6,35	1	18465	3,01
25	152	46	6,35	1	18466	3,41
26	152	46	6,35	1	18468	3,58
28	152	46	6,35	1	18469	3,86
30	152	46	6,35	1	18471	4,07
32	152	46	6,35	1	18472	4,35
35	152	46	6,35	1	55992	4,88
36	152	46	6,35	1	30389	5,02
38	152	46	6,35	1	30390	5,35
40	152	46	6,35	1	17864	5,37

D mm	L mm	I mm	d mm	📦	Nº Art.	€
6	400	38	6,35	1	55973	6,82
8	400	38	6,35	1	55974	6,82
10	400	38	6,35	1	55975	7,14
12	400	42	6,35	1	55976	7,90
14	400	42	6,35	1	55977	6,79
16	400	42	6,35	1	55978	7,46
18	400	42	6,35	1	55979	8,41
20	400	42	6,35	1	55980	8,41
22	400	42	6,35	1	55981	9,74
24	400	46	6,35	1	55982	10,44
25	400	46	6,35	1	55983	11,90
28	400	46	6,35	1	55984	13,40
30	400	46	6,35	1	55985	14,13
32	400	46	6,35	1	55986	15,18
35	400	46	6,35	1	55987	17,04



Set **1650**

8 Pcs

Cont. Ø	Nº Art.	€
12-16-18-20-22-25-28-32 mm	66378	23,30

Línea 1 m - Ref. 1650



ø	6	8	10	12	14	16	18	20	22	24	25	26	28	30	32	36	38	L305
Pcs	10	10	10	10	10	10	10	10	5	5	5	5	5	5	5	5	5	1

Ref. 4995 - Nº Art. 71051: **346,00 €**



Ref. **1621**

BROCA MADERA

Wood Drill Bit
Foret Bois

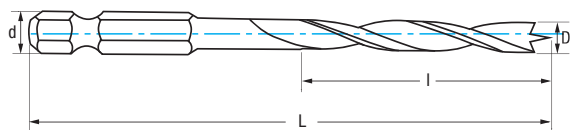

Maderas Blandas
Soft Wood
Bois tendre

D mm	L mm	l mm	d mm		Nº Art.	€
3,00	64	32	6,35	1	56002	3,05
4,00	74	40	6,35	1	56004	2,83
5,00	85	49	6,35	1	56005	2,69
6,00	89	57	6,35	1	56006	2,58
8,00	90	55	6,35	1	56008	2,77



Línea 33 cm - Ref. 1621



∅	3	4	5	6	8
Pcs	5	5	5	5	5

Ref. 4995 - Nº Art. 72201: **69,60 €**

Display 54 - Refs. 1611 - 1610 - 1601 - 1621

BROCAS METAL + PARED + MADERA

Metal + Masonry + Wood Drill Bits
Forets Métal + Maçonnerie + Bois



		Ref. 1611							
∅		2	3	3,25	3,5	4	5	6	8
Pcs		3	3	3	3	3	3	3	3
		Ref. 1610						Ref. 1601	
∅		M3	M4	M5	M6	M8	M10	4	5
Pcs		2	2	2	2	2	2	3	3
		Ref. 1601			Ref. 1621				
∅		6	8	10	3	4	5	6	8
Pcs		3	3	3	3	3	3	3	3

Ref. 4995 - Nº Art. 69804: **439,73 €**



Ref. **1461**

SET BROCAS MANGO HEXAGONAL 1/4" Y PUNTAS DE ATORNILLAR

Hexagonal Shank Drill Bit and Screwdriver Bit Set

Jeu de forets hexagonales et embouts vissage



6 Sets

Nº Art.	€
19291	111,89



Set 17 Pcs

Nº Art.	€
81601	19,63

Brocas Madera
Wood Drill Bits
Forets Bois
3- 4 - 5 - 6 mm

PH d mm: 6,35
PH1
PH2
PH3
L mm: 25

PZ d mm: 6,35
PZ1
PZ2
PZ3
L mm: 25

d mm: 6,35
Tx
T10
T15
T20
T25
T30
T40
L mm: 25

Adapt. Quick-Lock
INOX/Stainless
L mm: 60 - d mm: 6,35





Outils pour les matériaux les plus difficiles

izartool.com/fr

Ref. **1523**

PUNTA ATORNILLAR IMPACTO MANGO E6.3

Impact Screwdriver Bit E6.3 Shank
Embout visage Impact queue E6.3



New!

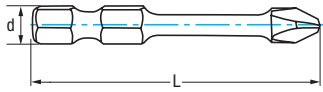

S2
material

60
HRC

d =
6,35 mm

- **Larga vida útil**
- **Soporta grandes pares de torsión**
- **Óptimo acople entre la punta y la cabeza del tornillo**
- **Long life**
- **Suitable for high-torque**
- **Optimal fit between the tip and the screw head**
- **Longue durée de vie**
- **Supporte de grands couples de torsion**
- **Adaptation optimale entre la pointe et la tête de la vis**

PHILLIPS



Tipo Type	L mm	DIN	Torque (Nm)		Nº Art.	€ pack
PH 1	50	E 6.3	5,00	2	58907	2,97
PH 2	50	E 6.3	14,00	2	22807	2,97
PH 3	50	E 6.3	33,60	2	22816	2,97

POZIDRIVE



PZ 1	50	E 6.3	5,00	2	58910	2,97
PZ 2	50	E 6.3	14,00	2	22818	2,97
PZ 3	50	E 6.3	29,40	2	22820	2,97

TORX



TX 20	50	E 6.3	12,70	2	22836	3,68
TX 25	50	E 6.3	19,00	2	22839	3,68
TX 30	50	E 6.3	37,40	2	22843	3,68
TX 40	50	E 6.3	65,10	2	22845	3,68



Ref. **1524**

PUNTA ATORNILLAR EXTRA LARGA

Extra Long Screwdriver Bit
Embout vissage extra-long

New!

Standard
d = 6,35 mm

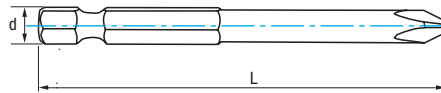

1
Uds



5
Uds

Tipo Type	D mm	L mm	DIN	Nº Art.	€ pack	Nº Art.	€ pack
--------------	---------	---------	-----	------------	-----------	------------	-----------

PHILLIPS



PH	1	75	E 6.3	23222	1,50	23225	6,39
PH	2	75	E 6.3	23270	1,47	23271	6,39
PH	3	75	E 6.3	23278	1,50	23279	6,39
PH	1	100	E 6.3	23227	1,72	23229	7,31
PH	2	100	E 6.3	23274	1,72	23275	7,31
PH	3	100	E 6.3	23280	1,72	23281	7,31
PH	1	150	E 6.3	23230	2,42	23231	10,30
PH	2	150	E 6.3	23276	2,42	23277	10,30
PH	3	150	E 6.3	23282	2,42	23283	10,30

POZIDRIVE



PZ	1	75	E 6.3	23284	1,50	23285	6,39
PZ	2	75	E 6.3	23290	1,50	23291	6,39
PZ	3	75	E 6.3	23296	1,50	23297	6,39
PZ	1	100	E 6.3	23286	1,72	23287	7,31
PZ	2	100	E 6.3	23292	1,72	23293	7,31
PZ	3	100	E 6.3	23298	1,72	23299	7,31
PZ	1	150	E 6.3	23288	2,42	23289	10,30
PZ	2	150	E 6.3	23294	2,42	23295	10,30
PZ	3	150	E 6.3	23300	2,42	23301	10,30

TORX



Tx	10	75	E 6.3	23330	1,59	23333	6,75
Tx	15	75	E 6.3	23342	1,59	23351	6,75
Tx	20	75	E 6.3	23359	1,59	23360	6,75
Tx	25	75	E 6.3	23366	1,59	23367	6,75
Tx	27	75	E 6.3	23384	1,59	23387	6,75
Tx	30	75	E 6.3	23395	1,59	23398	6,75
Tx	40	75	E 6.3	23408	1,59	23409	6,75
Tx	10	100	E 6.3	23334	1,81	23338	7,73
Tx	15	100	E 6.3	23352	1,81	23353	7,73
Tx	20	100	E 6.3	23361	1,81	23362	7,73
Tx	25	100	E 6.3	23374	1,81	23376	7,73
Tx	27	100	E 6.3	23388	1,81	23390	7,73
Tx	30	100	E 6.3	23399	1,81	23400	7,73
Tx	40	100	E 6.3	23410	1,81	23411	7,73
Tx	10	150	E 6.3	23339	2,53	23340	10,76
Tx	15	150	E 6.3	23355	2,53	23357	10,76
Tx	20	150	E 6.3	23364	2,53	23365	10,76
Tx	25	150	E 6.3	23382	2,53	23383	10,76
Tx	27	150	E 6.3	23392	2,53	23393	10,76
Tx	30	150	E 6.3	23404	2,53	23405	10,76
Tx	40	150	E 6.3	23414	2,53	23417	10,76



Ref. **1529**

ADAPTADORES PUNTAS ATORNILLAR

Screwdriver Bit Adaptors
Adaptateurs embouts vissage



Tipo Type	L mm	d mm		Nº Art.	€ pack
Quick Lock INOX / Stainless	60	6,35	1	82687	8,48



Tipo Type	L mm	d mm		Nº Art.	€ pack
Quick Lock	60	6,35	1	33746	7,07



Tipo Type	L mm	d mm		Nº Art.	€ pack
SDS plus	78	6,35	1	33745	19,06



Tipo Type	L mm	d mm		Nº Art.	€ pack
Magnético IND	60	6,35	1	33747	3,52

Adaptador Magnético para Tornillos
Magnetic Screw Adaptor
Adaptateur magnetique pour vis



Tipo Type	mm	L mm	d mm		Nº Art.	€
Adapt.	6	65	6,35	1	42466	3,66
Adapt.	7	65	6,35	1	42472	3,66
Adapt.	8	65	6,35	1	42475	3,66
Adapt.	10	65	6,35	1	42478	3,89
Adapt.	12	65	6,35	1	42481	3,89
Adapt.	13	65	6,35	1	42483	3,89

* Interno / Internal / Intérieur

New!

Adaptador de 1/4 a 1/2
1/4 to 1/2 Adaptor
Adaptateur de 1/4 à 1/2

Para uso de herramientas de mango E6.3(1/4)
en llaves de impacto 1/2

It allows the use of E6.3(1/4) shank tools on a 1/2 Impact wrench

Pour utiliser des outils à queue hexagonale E6.3(1/4)
avec clés à choc de 1/2



mm	L mm	d mm		Nº Art.	€ pack
12,7	50	6,35	1	75107	7,36



Set **1529**

Adaptador Magnético para Tornillos
Magnetic Screw Adaptor
Adaptateur magnetique pour vis

5 Pcs

D mm	L mm	d mm		Nº Art.	€
6-7-8-10-13	65	6,35	5	69751	18,76



Ref. **1527**

TOPE PROFUNDIDAD **PLADUR**

Plasterboard Depth Stop

Butée profondeur Placoplâtre



Tipo Type	D mm	L mm	DIN		Nº Art.	€ pack
PH	2	25	C 6.3	2	77339	3,59
PH	2	50	E 6.3	2	74858	4,48
PZ	2	25	C 6.3	2	81588	3,59
PZ	2	50	E 6.3	2	81589	4,48



Set 4 Pcs

Cont.	Nº Art.	€
PH2 - L25	81594	8,09
PH2 - L50		
PZ2 - L25		
PZ2 - L50		

Ref. **3407**

EXTRACTORES IMPACTO

Impact Extractor
Extracteurs impact

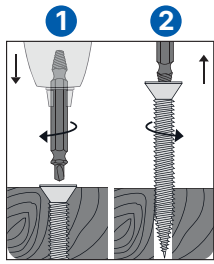

1. Taladrar el tornillo
2. Dar la vuelta y extraer

1. Drill the screw
2. Turn over and remove

1. Percer la vis
2. Retourner et retirez

Mod.	Cap. (mm)	Nº Art.	€
Nº 1	3-5	14953	6,32
Nº 2	4-8	14955	6,32
Nº 3	5-10	14956	6,32
* Nº 4	6-12	14958	6,32

- * Nº 4 no es válido para atornillador de impacto
- * Nº 4 is not suitable for impact drivers
- * Nº 4 n'est pas valide pour les visseuses impact



Set 17 Pcs

Nº Art.	€
72898	25,29



17
pcs

Extractores Impacto
Impact Extractors
Extracteurs impact
N.º 1 - 2 - 3 - 4

PH d mm: 6,35
PH1
PH2
PH3
L 25 mm

PZ d mm: 6,35
PZ1
PZ2
PZ3
L 25 mm

d mm: 6,35
Tx
T10
T15
T20
T25
T30
T40
L 25 mm

Adapt. Quick-Lock
L mm: 60 - d mm: 6,35

Box-Pallet - Ref. 3407



6 Sets

Nº Art.	€
74792	144,53



05.

SIERRAS

Saw Blades

Lames scies

OSCILANTES MULTI-FUNCIÓN

Oscillating Multi-Tools
Outils multifonction

358

SIERRAS SABLE

Sabre Saw Blades
Lames scie sabre

380

SIERRAS CALAR

Jig Saw Blades
Lames scies sauteuses





































396



CUADRO USO SIERRAS OSCILANTES MULTI-FUNCIÓN

Oscillating Multi-Tool Table

Tableau utilisation outils multifonction

Ref. Mod. Mat.		STARLOCK																	
		MADERA - Wood - Bois							METAL										
		2940	2940	2940	2940	2940	2940	2940	2910	2910	2910	2910	2910	2910	2910	2910	2910	2910	
		00010	00020	00030	00040	00050	00060	00070	00010	00020	00030	00040	00050	00060	00070	00080	00090	00100	
		HCS	HCS	Bime-tal	HCS	HCS	Bime-tal	HCS	MD HM	MD HM	Bime-tal	Bime-tal	Bime-tal	Bime-tal	Bime-tal	Bime-tal	Bime-tal	Bime-tal + TIN	
																			
 Madera Blanda Soft Wood / Bois tendre		●	○	○	●	○	○	●				●	●	●	●	●	●	●	●
 Madera Dura Hard Wood / Bois dur			●	●		●	●					●	●	●	●	●	●	●	●
 Madera+Clavos Wood+Nails / Bois+Clous									●	●		○		●	●				
 Metal									○	○	●	●	●	●	●	●	●	●	●
 INOX / Stainless / Inox									●	●					○				
 Plástico / Plastics / Plastique		○				○		○				○	○	○		○	○	○	○
 Fibra Vidrio Fibreglass / Fibre verre									○	○									
 Abrasivos Abrasive / Abrasifs									○	○									
 Pladur / Drywall / Plâtre									○	○	○	○	○						
 No ferrosos Non-ferrous / Non ferreux												○	○	○	○				
 Perfiles / Profiles / Profils																	○	○	○
 Parquet-Laminados Laminated-Parquet Parquet-Laminés																	○	○	
 GFK																			○
 Cerámica Ceramics / Céramique																			
 Grout-Mortero Grout-Mortar Coulies-Mortier																			
 Pulido / Sanding / Poncer																			
 Aislamiento Isolating / Isolant																			
 Caucho Rubber / Caoutchouc																			
 Cuero / Leather / Cuir																			
 Restos blandos (pegamento, moqueta, silicona...) Soft remains (glue, carpet, silicone...) Restes tendres (colle, moquette, silicone...)																			



OSCILANTES MULTI-FUNCIÓN

Oscillating Multi-Tools Outils multifonction

LA GAMA MÁS COMPLETA PARA TODOS LOS MATERIALES

The most complete range for every material

La gamme plus complète pour tous les matériaux

Para serrar, cortar, rascar, fresar y escofinar
For sawing, cutting, scraping, milling and rasping
Pour scier, couper, fraiser et gratter



COMPATIBILIDAD / Compatibility / Compatibilité

Starlock:

Bosch GOP 12-28, PMF 220 CE, PMF 250 CES

Starlock Plus:

Bosch GOP 30-28, Bosch GOP 40-30, Bosch GOP 18V-28, Bosch PMF 350 CES, Fein AFMT 12 SL, Fein AFMT 12 QSL, Fein AFMM 18 QSL, Fein FMT 250 SL, Fein FMT 250 QSL, Fein FMM 350 QSL, Fein Multimaster, Fein Multitalent

Starlock Max:

Bosch GOP 55-36, Fein AFSC 18 QSL, Fein AFSC 18 QCSL, Fein FSC 500 QSL

OTROS Others Autres:

Bosch GOP, Bosch PMF, Fein Multimaster, Fein Multitalent, Makita, Hitachi, Metabo, Milwaukee, AEG, Einheil, Ryobi, Skil...

STARLOCK



MADERA
Wood
Bois



METAL



ESPECIAL
Special
Spécial

IZAR
CUTTING TOOLS



STARLOCK

OSCILANTES MULTI-FUNCIÓN

Oscillating Multi-Tools

Outils multifonction

Ref. **2940**

MADERA Wood Bois



Mod **00010**

CORTE CURVO MADERAS BLANDAS

Curve Cutting in Soft Wood
Coupe courbe pour bois tendre

Mod.		Nº Art.	€
00010	1	69095	20,47

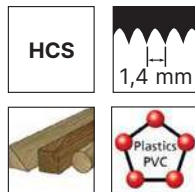
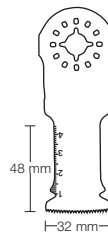

Corte limpio y preciso en maderas blandas y plásticos. Filos de corte redondeados para evitar sacudidas y conseguir una profundización suave del corte. Serrado cerca de bordes, en esquinas y zonas de difícil acceso, como p.e. ventanas estrechas para montar rejillas de ventilación.

Clean and precise cuts in softwood and plastics. Rounded cutting edges for jolt-free and smooth plunge cutting. Sawing near edges and difficult-to-reach areas, such as tight windows to install grilles.

Coupe propre et précise sur bois tendres et plastiques. Filets de coupe arrondis pour éviter les secouées et obtenir une profondeur plus douce de la coupe. Serrage près des bords, en corners et surfaces d'accès difficile, comme fenêtres étroites pour fixer des grilles de ventilation.



Mod **00020**

CORTE CURVO MADERAS DURAS

Curve Cutting in Hard Wood
Coupe courbe pour bois dur

Mod.		Nº Art.	€
00020	1	69096	20,47

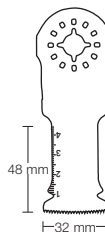

Corte limpio y preciso en maderas, sobre todo duras. Filos de corte redondeados para evitar sacudidas y conseguir una profundización suave del corte.

Clean and precise cuts in Wood, specially in hard wood. Rounded cutting edges for jolt-free and smooth plunge cutting.

Coupe propre et précise sur bois, surtout durs. Filets de coupe arrondis pour éviter les secouées et obtenir une profondeur plus douce de la coupe.





Mod **00030**

CORTE CURVO ALTO RENDIMIENTO MADERAS DURAS

High Performance Curve Cutting in Hard Wood
Coupe courbe haut rendement pour bois dur

Mod.		N° Art.	€
00030	1	69097	25,42

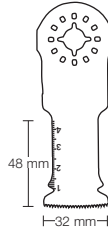

Bimetal	1,8 mm
	Dentado japonés Japanese Teeth Denture japonais

Corte limpio y preciso en maderas, sobre todo duras. Filos de corte redondeados para evitar sacudidas y conseguir una profundización suave del corte.

Clean and precise cuts in Wood, specially in hard wood. **Rounded cutting edges for jolt-free and smooth plunge cutting.**

Coupe propre et précise sur bois, surtout durs. Filets de coupe arrondis pour éviter les secouées et obtenir une profondeur plus douce de la coupe.



Mod **00040**

CORTE CURVO MADERAS BLANDAS

Curve Cutting in Soft Wood
Coupe courbe pour bois tendre

Mod.		N° Art.	€
00040	1	69099	23,60

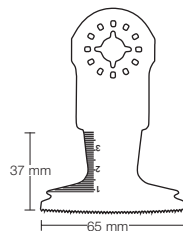

HCS	1,3 mm
	Plastics PVC

Corte limpio y preciso en maderas blandas y plásticos. Filos de corte redondeados para evitar sacudidas y conseguir una profundización suave del corte.

Clean and precise cuts in softwood and plastics. **Rounded cutting edges for jolt-free and smooth plunge cutting.**

Coupe propre et précise sur bois, surtout durs. Filets de coupe arrondis pour éviter les secouées et obtenir une profondeur plus douce de la coupe.





Mod **00050**

CORTE CURVO MADERAS DURAS

Curve Cutting in Hard Wood
Coupe courbe pour bois dur

Mod.		N° Art.	€
00050	1	69102	24,03

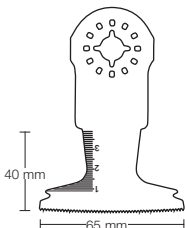

HCS



Dentado japonés
Japanese Teeth
Denture japonais

Corte limpio y preciso en maderas, sobre todo duras. Filos de corte redondeados para evitar sacudidas y conseguir una profundización suave del corte.

Clean and precise cuts in Wood, specially in hard wood. Rounded cutting edges for jolt-free and smooth plunge cutting.

Coupe propre et précise sur bois, surtout durs. Filets de coupe arrondis pour éviter les secouées et obtenir une profondeur plus douce de la coupe.



Mod **00060**

CORTE CURVO ALTO RENDIMIENTO MADERAS DURAS

High Performance Curve Cutting in Hard Wood
Coupe courbe haut rendement pour bois dur

Mod.		N° Art.	€
00060	1	69103	29,35

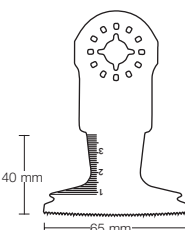

Bimetal



Dentado japonés
Japanese Teeth
Denture japonais

Corte limpio y preciso en maderas, sobre todo duras. Filos de corte redondeados para evitar sacudidas y conseguir una profundización suave del corte.

Clean and precise cuts in Wood, specially in hard wood. Rounded cutting edges for jolt-free and smooth plunge cutting.

Coupe propre et précise sur bois, surtout durs. Filets de coupe arrondis pour éviter les secouées et obtenir une profondeur plus douce de la coupe.



Mod 00070

HOJA SIERRA SEGMENTADASegmented Saw Blade
Lame segmenté

Mod.		Nº Art.	€
00070	1	69104	23,68

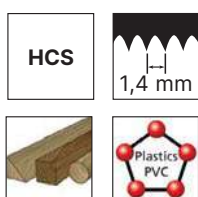
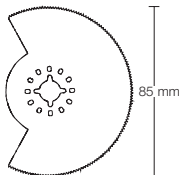

Corte limpio y preciso en maderas y plásticos. Tronzado de tubos de plástico, rejillas de ventilación, espigas salientes en uniones de madera. Recorte de molduras o marcos de puerta ya instalados; cortes de inmersión para ajustar tarimas.

Clean and precise cutting of wood and plastic. Parting of plastic pipes, grilles, protrusions in wood-unions. Installed (door) frames cutting; wood flooring plunge cutting.

Coupe propre et précise sur bois et plastiques. Tronçage sur tube en plastiques, grilles de ventilation, chevilles d'union en bois. Coupure des cadres de portes déjà installés, coupes d'immersion pour fixer les parquets.



Mod 00010

ALTO RENDIMIENTO INOX / CLAVOS

Heavy Duty Stainless / Nails
Haut rendement Inox / Clous

Mod.		N° Art.	€
00010	1	69105	32,81

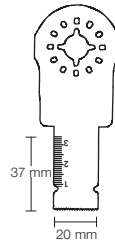

MD HM Carbure	 1,1 mm	
 Inox Stainless		 Fibra Vidrio Fibreglass

Corte limpio y preciso en metal, inoxidable, tornillos, clavos, fibra vidrio, abrasivos, pladur, barras de hierro, tubos negros, grapas.

Clean and precise cuts in metal, stainless Steel, hardened screws, nails, fibreglass, abrasives, drywall, iron bars, black pipes, staples.

Coupe propre et précise sur aciers, Inox, vis, clous, fibre de verre, abrasifs, barreaux de fer, tubes noirs et agrafes.



Mod 00020

ALTO RENDIMIENTO INOX / CLAVOS

Heavy Duty Stainless / Nails
Haut rendement Inox / Clous

Mod.		N° Art.	€
00020	1	69106	40,62

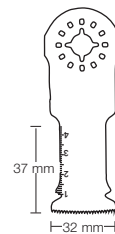

MD HM Carbure	 1,1 mm	
 Inox Stainless		 Fibra Vidrio Fibreglass

Corte limpio y preciso en metal, inoxidable, tornillos, clavos, fibra vidrio, abrasivos, pladur, barras de hierro, tubos negros, grapas.

Clean and precise cuts in metal, stainless Steel, hardened screws, nails, fibreglass, abrasives, drywall, iron bars, black pipes, staples.

Coupe propre et précise sur aciers, Inox, vis, clous, fibre de verre, abrasifs, barreaux de fer, tubes noirs et agrafes.



Mod 00060

CORTE CURVO Y RÁPIDO METAL / MADERA / CLAVOS

Curve & Fast Cutting in Metal / Wood / Nails
Coupe courbe et rapide dans Métal / Bois / Clous

Mod.		Nº Art.	€
00060	1	69111	25,42

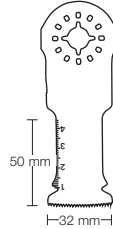

Bimetal	1,3 mm		

Corte limpio y preciso en metal, madera, maderas con clavos, plásticos y materiales no ferrosos. Filos de corte redondeados para evitar sacudidas y conseguir una profundización suave del corte.

Clean and precise cuts in metal, wood, wood with nails, plastics and non-ferrous materials. Rounded cutting edges for jolt-free and smooth plunge cutting.

Coupe propre et précise sur aciers, bois, bois avec clous, plastiques et aciers non ferreux. Filets de coupe arrondis pour éviter des secouées et obtenir une profondeur plus douce de la coupe.



Mod 00030

CORTE RECTO METAL / MADERA

Straight Cut Metal / Wood
Coupe droite Métal / Bois

Mod.		Nº Art.	€
00030	1	69107	14,71

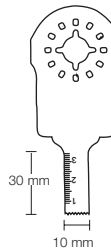

Bimetal	1,3 mm		

Corte limpio y preciso en metal, madera y plásticos, metales no ferrosos, cerraduras, pladur. Aberturas para cajas de enchufe, separación de tubos de cobre a ras de superficie, cortes de inmersión en paneles de cartón enyesado.

Clean and precise cuts in metal, Wood and plastics, non-ferrous metals, locks, drywall. Opening of socket-boxes, separating copper pipes at surface level, plunge cutting in plastered carton-panels.

Coupe propre et précise sur aciers, bois et plastiques, aciers non ferreux, serrures. Ouvertures pour prises, séparation de tubes en cuivres à ras de sol, coupe d'immersion sur panneaux en plâtre.





Mod 00040

CORTE RECTO METAL / MADERA

Straight cutting of Metal / Wood
Coupe droit Métal / Bois

Mod.		N° Art.	€
00040	1	69108	15,49

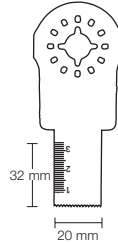

Bimetal	1,3 mm	

Corte limpio y preciso en metal, madera, plásticos y materiales no ferrosos, pladur, clavos, tubos a ras de superficie.

Clean and precise cuts in metal, Wood, plastics and non-ferrous materials, drywall, nails, pipes at the level of the surface.

Coupe propre et précise sur aciers, bois, plastiques et aciers non ferreux, clous, tubes à ras de sol.



Mod 00050

CORTE RECTO METAL / MADERA

Straight cutting of Metal / Wood
Coupe droit Métal / Bois

Mod.		N° Art.	€
00050	1	69109	22,16

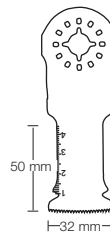

Bimetal	1,3 mm	

Corte limpio y preciso en metal, madera, plásticos y materiales no ferrosos, pladur.

Clean and precise cuts in metal, Wood, plastics and non-ferrous materials, drywall.

Coupe propre et précise sur aciers, bois, plastiques et aciers non ferreux, plâtre.



Mod 00070

CORTE CURVO Y RÁPIDO METAL / MADERA / CLAVOS

Curve & Fast Cutting in Metal / Wood / Nails
Coupe courbe et rapide dans Métal / Bois / Clous

Mod.		Nº Art.	€
00070	1	69112	31,23

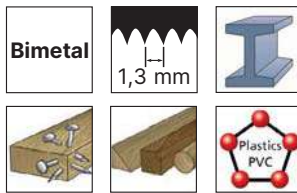
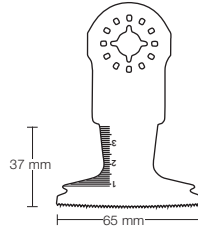

Corte limpio y preciso en metal, madera, maderas con clavos y plásticos. Filos de corte redondeados para evitar sacudidas y conseguir una profundización suave del corte.

Clean and precise cuts in metal, wood, wood with nails and plastics. Rounded cutting edges for jolt-free and smooth plunge cutting.

Coupe propre et précise sur aciers, bois, bois avec clous et plastiques. Filets de coupe arrondis pour éviter des secouées et obtenir une profondeur plus douce de la coupe.



Mod 00080

SIERRA SEGMENTADA. CORTE FINO METAL / MADERA

Segmented Blade. Fine cutting of Metal / Wood
Lame segmenté. Coupe fin dans Métal / Bois

Mod.		Nº Art.	€
00080	1	69113	30,72

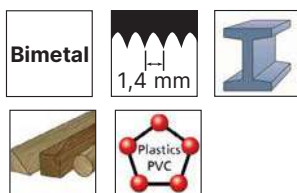
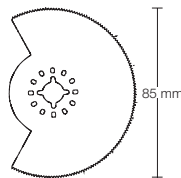

Corte limpio y preciso en metal, madera y plásticos. Recorte de marcos de puertas a ras de suelo, laminados, parquet, listones para perfiles.

Clean and precise cuts in metal, wood, wood with nails and plastics. Door-frame trimming at the level of the floor, laminated, parquet, profile-strips.

Coupe propre et précise sur aciers, bois, bois avec clous et plastiques. Filets de coupe arrondis pour éviter des secouées et obtenir une profondeur plus douce de la coupe.





Mod 00090

SIERRA SEGMENTADA. ALTO RENDIMIENTO METAL / MADERA

Segmented Blade. High performance in Metal / Wood
Lame segmenté. haut rendement dans Métal / Bois

Mod.		N° Art.	€
00090	1	69114	42,02

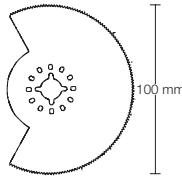

Bimetal	1,7 mm	

Corte limpio y preciso en metal, madera y plásticos. Recorte de marcos de puertas a ras de suelo, laminados, parqueté, listones para perfiles.

Clean and precise cuts in metal, wood, wood with nails and plastics. Door-frame trimming at the level of the floor, laminated, parquet, profile-strips.

Coupe propre et précise sur aciers, bois et plastiques. Coupures de cadres de portes à ras de sol, laminés, parquets et profils.



Mod 00100

CORTE CURVO MADERAS BLANDAS

Curve Cutting in Soft Wood
Coupe courbe pour bois tendre

Mod.		N° Art.	€
00100	1	69115	43,68

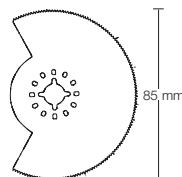

Bimetal + TIN	1,5 mm	

Corte limpio y preciso en metal, madera y plásticos. Dientes recubiertos en titanio para una mayor vida de la herramienta. Corte de entalladuras en epoxy, GFK, listones pequeños para perfiles.

Clean and precise cuts in metal, wood, wood with nails and plastics. Titanium coated teeth for a longer lifetime. Cutting of epoxy-joinings, GFK, small profile-strips.

Coupe propre et précise sur aciers, bois et plastiques. Dents recouvertes en titane pour une plus longue vie de l'outil. Coupure dans les bords, petites barres pour profils.



Mod **00010**

PLACA LIJADORA

Sanding Plate
Patin de ponçage

Mod.		N° Art.	€
00010	1	69116	21,30

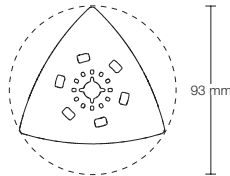

Placa para pulir con fijación tipo micro-velcro.
Sanding plate with micro-velcro type fastening.
Patin de ponçage avec aspiration des poussières.



Mod **00020**

PLACA LIJADORA DESBASTE

Sanding Plate for Roughing
Patin de ponçage ébauche

Mod.		N° Art.	€
00020	1	69117	40,35

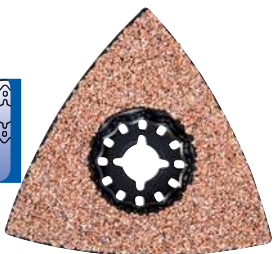
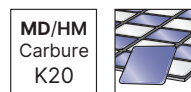
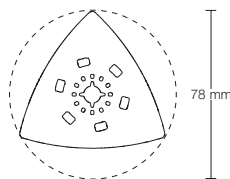

Ideal para eliminar mortero, adhesivo de azulejos y residuos de adhesivos en alfombras, incluso en esquinas gracias a su forma triangular.

Ideal for removing mortar, tile adhesive and carpet adhesive residues even in the corners with the triangle shape.

Conseillé pour supprimer le mortier, colle de carrelage et copeaux collants sur tapis, même aux corners grâce à sa forme triangulaire.





Mod 00030

SIERRA SEGMENTADA + PLACA LIJADORA
Segmented Saw + Sanding Plate
Lame segmenté à concretion carbure plus patin de ponçage

Mod.	N° Art.	€
00030	1 69118	69,02

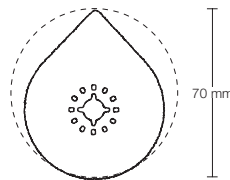

MD/HM Carbure K40	2 mm
	Medium



Ideal para eliminar grout y mortero de juntas de paredes y suelos, incluso en las esquinas más remotas.

Ideal for removing grout & mortar from Wall and floor tiles, even in the most remote corners.

Conseillé pour supprimer mortier sur joints de murs et sols, même sur les corners plus difficiles.



Mod 00060

SIERRA INMERSIÓN ABRASIVOS
Plunge Saw for Abrasives
Lame immersion abrasifs

Mod.	N° Art.	€
00060	1 69121	41,30

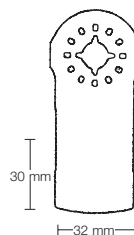

MD/HM Carbure K50	2 mm	
		Fibra Vidrio Fibreglass
	Medium	

Corte profundo en materiales muy abrasivos como la fibra de vidrio. Filos de corte redondeados para evitar sacudidas y conseguir una profundización suave del corte.

Plunge cutting in strongly abrasive materials, such as fibreglass. Rounded cutting edges for jolt-free and smooth plunge cutting.

Coupe profonde sur matériaux abrasifs comme la fibre de verre. Filets de coupe arrondis pour éviter les secouées et obtenir une profondeur douce de la coupe.



Mod **00040**

SIERRA INMERSIÓN LIJADO FINO

Plunge Saw for Fine Sanding
Râpe à concretion carbure

Mod.		N° Art.	€
00040	1	69119	38,16

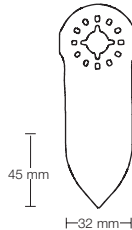

MD/HM
Carbure
K100



Pulido de residuos de pintura, madera, plásticos, composites, epoxy. Ranurado en espacios estrechos y áreas remotas. Usar a 2/3 de la velocidad máxima. Lijado de madera o pintura en zonas de difícil acceso sin papel de lijar.

Sanding of Paint residues, Wood, plastic, composite, epoxy. Slotting in tight gaps and hard-to-reach areas. Use 2/3 of maximum speed. Sanding of wood or painting in difficult-to-reach areas without sanding-paper.

Dégrossissage de residus de peinture, bois, plastiques et composites. Rainurage sur endroits exigus et zones difficiles. Utilisez à 2/3 de la vitesse maximale. Ponçage de peinture ou bois sur zones de difficile accès sans papier de ponçage.



Mod **00050**

SIERRA INMERSIÓN LIJADO DESBASTE

Plunge Saw for Rough Sanding
Râpe à concretion carbure ébauche

Mod.		N° Art.	€
00050	1	69120	38,16

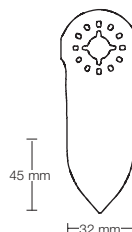

MD/HM
Carbure
K40



Pulido de residuos de pintura, madera, plásticos, composites, epoxy. Ranurado en espacios estrechos y áreas remotas. Usar a 2/3 de la velocidad máxima.

Sanding of Paint residues, Wood, plastic, composite, epoxy. Slotting in tight gaps and hard-to-reach areas. Use 2/3 of maximum speed.

Dégrossissage de residus de peinture, bois, plastiques et composites. Rainurage sur endroits exigus et zones difficiles. Utilisez à 2/3 de la vitesse maximale.





Mod **00070**

CORTE GRUESO ENTRE AZULEJOS



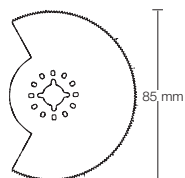

Rough Cutting among Tiles
Coupe grosse carreaux

Mod.		N° Art.	€
00070	1	69122	45,00



Alineado de juntas en azulejos de pared y suelo.
Precise routing joints on wall and floor tiles.
Pour aligner les joints sur carreaux murs et sols.



MD/HM Carbure K30	 2 mm	 Fibra Vidrio Fibreglass
		Grueso Coarse Gross



Mod **00080**

CORTE FINO ENTRE AZULEJOS



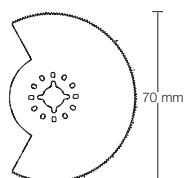

Fine Cutting among Tiles
Coupe fine carreaux

Mod.		N° Art.	€
00080	1	69123	38,41



Alineado de juntas en azulejos de pared y suelo.
Precise routing joints on wall and floor tiles.
Pour aligner les joints sur carreaux murs et sols.



MD/HM Carbure K40	 1,4 mm	 Plastics PVC
		Medium



Mod **00090**

CORTE DIAMANTE AZULEJOS EXTERIOR

Diamond Cutting of Outer Tiles
Coupe diamant carreaux extérieur

Mod.		N° Art.	€
00090	1	69124	77,09

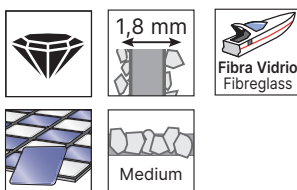
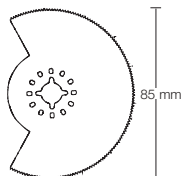

Alineado de juntas en azulejos de pared y suelo. Separación de azulejos, resinas epoxi y plásticos reforzados con fibra de vidrio.

Precise routing joints on wall and floor tiles. Separating of tiles, epoxi gum and fibreglass reinforced plastics.

Pour aligner les joints sur carreaux murs et sols. Séparation de carreaux, résines et plastiques renforcées avec fibre de verre.



Mod **00100**

DENTADO ONDULADO AISLANTES

Waved Teeth for Isolating
Denture vague isolation

Mod.		N° Art.	€
00100	1	69126	43,21

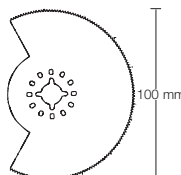

Ideal para materiales de aislamiento como el poliestireno, espuma rígida, materiales blandos como alfombras, caucho, cuero... Cortes a ras de suelo de material sobresaliente.

Ideal for isolating materials, such as polystyrene, rigid foam, soft materials such as carpets, rubber, leather... Cutting of protruding material at floor level...

Conseillé pour matériaux isolation comme le polystyrène, mousse rigide, matériaux tendres comme tapis, cuire... Coupe à ras de sol des matériaux dépassants





Mod **00110**

RASCADORA

Scraper
Racloir

Mod.		N° Art.	€
00110	1	69127	14,92

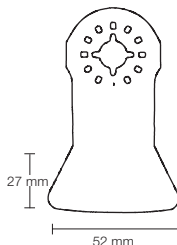

HCS

Restos blandos de pegamento, moqueta, material aglutinante, material de juntas, silicona...
Soft remains of glue, carpet, agglutinative material, joint-material, silicone...
Copeaux tendres de colle, tapis, matière aglutinantes, matériel de jointes, ...



Mod **00120**

DENTADO ONDULADO AISLANTES

Waved Teeth for Isolating
Denture vague isolation

Mod.		N° Art.	€
00120	1	69129	26,84

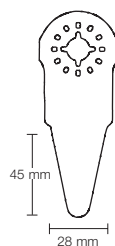

HCS



Juntas de expansión blanda y materiales de aislamiento, silicona en ventanas.
Soft expanding joints and insulating materials, silicone in windows.
Jointes d'expansion tendres et matériaux. silicones en fenêtres.



Mod **00130**

CORTE PRECISO MATERIALES BLANDOS Y ABRASIVOS

Precise Cutting of Soft Materials and Abrasives
Coupe précis de matériaux moelleux et abrasifs

Mod.		Nº Art.	€
00130	1	69130	32,83

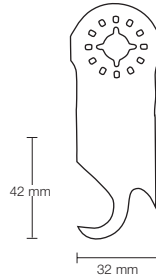

Corte rápido y preciso de material blando y material flexible abrasivo, p.e. alfombras, cartón, PVC...

Fast and precise cutting of soft material and abrasive flexible material, such as carpets, carton, PVC...

Coupe propre et précise sur bois tendres et matériaux flexibles abrasifs. Tapis, cartons, PVC.



SETS

Ref. 2900

SETS MULTI-FUNCIÓN

Oscillating Multi-Tool Sets
Jeux de outils multifonction

Ref. 2940-2910

Ref. 2930

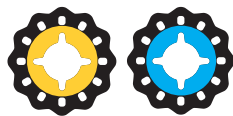

MADERA
Wood Bois
+ METAL

4 Pcs

Cont.	Nº Art.	€
Ref. 2940: Mod. 00030	69702	122,68
Ref. 2910: Mods. 00020-00060-00070		



ESPECIAL
Special
Spécial

4 Pcs

Cont.	Nº Art.	€
Ref. 2930: Mods. 00020-00060-00070-00080	69704	165,06





Línea 1 m 2900 - Refs. 2910 - 2930 - 2940

25 cm		Ref.	2910	2910	2910	2910	2930	2930	2940	2940	2940
			00030	00050	00070	00080	00080	00110	00020	00030	00070
		Pcs	3	3	3	3	3	3	3	3	3

Ref. 4995 - N° Art. 72189: **665,16 €**

Display 53 - Refs. 2940 - 2910 - 2930



Ref. 2940			
∅	Mod. 00020	Mod. 00030	Mod. 00070
Pcs	3	3	3
Ref. 2910			
∅	Mod. 00030	Mod. 00050	Mod. 00070
Pcs	3	3	3
Ref. 2910		Ref. 2930	
∅	Mod. 00080	Mod. 00080	Mod. 00110
Pcs	3	3	3

Ref. 4995 - N° Art. 69451: **665,16 €**



Mod 00010

CORTE RECTO MADERAS BLANDAS

Soft Wood Straight Cutting
Coupe droite bois tendre

Mod.		Nº Art.	€ Pack
00010	5	69140	55,79

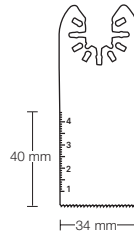

Dentado estándar. Corte en madera y plástico.

Standard teeth for wood and plastics.

Denture estándar. Coupe en bois et plastique.



Mod 00020

CORTE RECTO MADERAS DURAS

Hard Wood Straight Cutting
Coupe droite bois dur

Mod.		Nº Art.	€ Pack
00020	5	69141	80,94

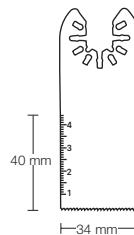

Dentado ondulado universal. Corte en madera, plástico, pladur, metal y madera con clavos.

Universal wave teeth for wood, plastics, drywall, metal and wood with nails.

Denture vague universelle. Coupe en bois, plastique, plâtre, métal et bois avec clous.



Mod 00030

CORTE RECTO ALTO RENDIMIENTO MADERAS DURAS

Hard Wood High Performance Straight Cutting
Coupe droite haut rendement bois dur

Mod.		Nº Art.	€ Pack
00030	5	69142	57,64

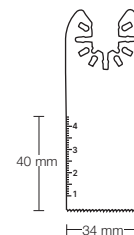

Dentado japonés para corte en madera, contrachapado, plástico y otros materiales blandos.

Japanese teeth for wood, plywood, plastics and other soft materials.

Denture japonaise pour coupe en bois, tole fine metal, plastiques et autres bois tendres.



Ref. 2950

MULTI



QUICK-FIT



Mod 00040

RASCADORA
Scraper
Racloir

Mod.		N° Art.	€ Pack
00040	5	69457	35,43

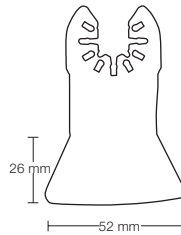

Rascador de silicona o similares en superficies lisas y delicadas como azulejos o cristal.

Removing of silicone or caulking against a flat surface such as tile or glass that can be easily scratched.

Racloir silicone ou similaire pour surfaces lises et délicats comme carreaux ou verre.



Ref. 2960

MULTI



SUPERCUT



Mod 00010

CORTE RECTO METAL / MADERA / CLAVOS
Straight Cutting in Metal / Wood / Nails
Coupe droite dans Métal / Bois / Clous

Mod.		N° Art.	€ Pack
00010	5	69143	80,94

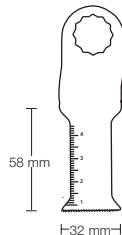

Dentado ondulado universal para madera, pladur, plástico, metal y madera con clavos. Mango acero inoxidable.

Universal wave teeth for wood, drywall, plastics, metal and wood with nails. Stainless steel holder.

Denture vague universelle pour bois, plâtre, plastique, métal et bois avec clous. Queue en acier inoxydable.



Mod 00020

CORTE RECTO METAL / MADERA / CLAVOS
Straight Cutting in Metal / Wood / Nails
Coupe droite dans Métal / Bois / Clous

Mod.		N° Art.	€ Pack
00020	5	69144	83,75

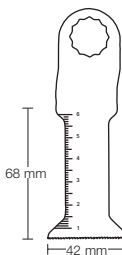

Dentado ondulado universal para madera, pladur, plástico, metal y madera con clavos. Mango acero inoxidable.

Universal wave teeth for wood, drywall, plastics, metal and wood with nails. Stainless steel holder.

Denture vague universelle pour bois, plâtre, plastique, métal et bois avec clous. Queue en acier inoxydable.



CUADRO USO SIERRAS SABLE

Sabre Blade Use Table
Tableau utilisation lames scies sabre

							MADERA Wood - Bois				PLÁSTICOS Plastics - Plastiques			ME- TAL		
							Todos tipos All types Toutes sortes	Dura Hard Dur	Pallet Palet Palette	Marcos ventana Window frames Fenêtres	Con clavos With nails Avec clous	Viva Green Vert	Plásticos Plastics Plastiques	Reforzados fibra-carbón Carbon-fibre reinforced Renforcés fibre-carbone	Plexiglas Perspex	INOX Stainless
							● Ideal ● Ideal - Idéal									
							○ Adecuado ○ Suitable - Convenable									
Ref. - Mod.	Equiv.	Mat.	TPI	I mm	Pág.											
Madera Wood - Bois	1950 00010	S1617K	HCS/CV	3	280	382	●	○				●				
		00020	S644D	HCS/CV	6	130	382	●	○				●			
		00030	S1531L	HCS/CV	4-5	220	383					●				
		00210	S2345X	HCS/CV	6	220	383	●	○				●		●	
		00220	S611VF	Bi-metal	5-8	130	384	●	○		●					
		00230	S1111VF	Bi-metal	5-8	205	384	●	○		●					
Metal Metal - Métal	1920 00020	S922EF	Bi-metal	18	130	385									●	
		00030	S922BF	Bi-metal	14	130	386								●	
		00050	S1025VF	Bi-metal	10-14	180	387			●		●				
		00200	S1122EF	Bi-metal	18	180	385								●	
		00210	S1122BF	Bi-metal	14	180	386								●	
		00220	S922HF	Bi-metal	10	130	387								●	
		00230	S1122HF	Bi-metal	10	180	388								●	
		00240	S1211HF	Bi-metal	10	260	388								●	
		00250		Bi-metal	10-14	130	389				●					
		00260	S123XF	Bi-metal	10-14	205	389				●					
	00280		Bi-metal	10	280	389				●				●		
Especial Special	1960 00020	S922VF	Bi-metal	10-14	130	390	●	○	●		●					
		00030	S1122VF	Bi-metal	10-14	205	390	●	○	●		●				
		00040	S611DF	Bi-metal	6	130	391	●	○				●			
		00060	S1411DF	Bi-metal	6	280	391	●	○				●			
		00200	S1141HM	CV-HM	3	205	392	○	●					●		
		00210	S1241HM	CV-HM	3	280	392	○	●					●		
		00220	S1211K	INOX	4	280	394	●	○							
		00240	S1213AWP	HCS/CV		280	394									
		00260	S1243HM	CV-HM	2	305	393									
		00270	S2243HM	CV-HM	2	455	393									



SIERRAS SABLE

Sabre Saw Blades

Lames scie sabre

Ref. **1950**

MADERA Wood Bois

Mod **00010**

CORTE BASTO

Rough Cut
Coupe grosse



S1617K



Dentado alterno y afilado diagonal. Corte basto para madera en general y madera viva.

Side set and diagonally sharpened toothing. Rough cutting of wood and green wood.

Denture avoyée, dépouillée et affûtée. Coupe grosse dans différents types de bois et bois verts.

Mod.	TPI	Diente Tooth Dent mm	L mm	I mm		Nº Art.	€ pack
00010	3	8,5	300	280	5	18870	23,99



Mod **00020**

CORTE RÁPIDO RECTO

Straight Fast Cut
Coupe rapide droite



S644D



Dentado alterno y afilado diagonal. Corte rápido y recto en todo tipo de maderas, plásticos y pladur.

Side set and diagonally sharpened toothing. Fast and straight cutting for all wood types, plastics and drywall.

Denture avoyée, dépouillée et affûtée. Coupe rapide et droite dans différents types de bois, plastiques et plâtres.

Mod.	TPI	Diente Tooth Dent mm	L mm	I mm		Nº Art.	€ pack
00020	6	4,2	150	130	5	18871	15,99



Mod 00030

MADERA VIVA

Green Wood
Bois verts



S1531L



Dentado alterno reforzado por inducción con afilado diagonal. Especial madera viva.

Side set and diagonally sharpened induction hardened tootinging. Special for green wood.

Denture avoyée, dépouillée, affûtée et traitée inductivement. Spécial pour bois verts.

Mod.	TPI	Diente Tooth Dent mm	L mm	I mm		Nº Art.	€ pack
00030	4-5	6,35-5	300	280	5	18872	25,37



Mod 00210

CORTE LIMPIO

Clean Cut
Coupe propre



S2345X

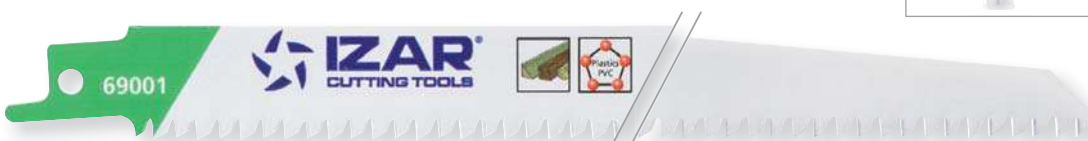

Dentado afilado triple. Corte limpio en todo tipo de maderas y plásticos.

Triply sharpened tootinging. Clean cutting of all types of wood and plastics.

Denture triple dépouillée et affûtée. Coupe propre dans différents types de bois et plastiques.

Mod.	TPI	Diente Tooth Dent mm	L mm	I mm		Nº Art.	€ pack
00210	6	4,2	240	220	5	69001	25,59



Mod 00220

CORTE RECTO ANCHO ESPECIAL

Special Thick Straight Cut
Coupe droite très grosse



S611VF

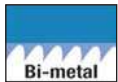

TPI
5-8



Dentado alterno y variable. Ancho de sierra especial para corte recto en todo tipo de maderas con residuos de metales.

Side set and variable tothing. Special thick blade for straight cutting of all wood types with few metal residues.

Denture fraisée, affûtée et variable. Lame très grosse pour coupe droite dans différents types de bois.

Mod.	TPI	Diente Tooth Dent mm	L mm	I mm		Nº Art.	€ pack
00220	5,8	5-3,2	150	130	5	69002	23,96



Mod 00230

CORTE RECTO LARGO ANCHO ESPECIAL

Special Thick Long Straight Cut
Coupe droite longue très grosse



S1111VF



TPI
5-8



Dentado alterno y variable. Ancho de sierra especial para corte recto en todo tipo de maderas con residuos de metales.

Side set and variable tothing. Special thick blade for straight cutting of all wood types with few metal residues.

Denture fraisée, affûtée et variable. Lame très grosse pour coupe droite dans différents types de bois.

Mod.	TPI	Diente Tooth Dent mm	L mm	I mm		Nº Art.	€ pack
00230	5-8	5-3,2	225	205	5	69003	31,94



Mod 00020

UNIVERSAL CORTE FLEXIBLE

Universal Flexible Cut
Universel coupe flexible



S922EF



TPI
18



Dentado fresado y ondulado. Sierra flexible y universal para aceros e inoxidables.

Milled teeth and wavy set. Flexible and universal blade for steel and stainless steel.

Dents fraisés et ondulés. Lame flexible et universel pour aciers et Inox.

Mod.	TPI	Diente Tooth Dent mm	L mm	I mm		Nº Art.	€ pack
00020	18	1,4	150	130	5	18865	16,92



Mod 00200

UNIVERSAL CORTE FLEXIBLE LARGO

Universal Long Flexible Cut
Universel coupe flexible longue



S1122EF



TPI
18



Dentado fresado y ondulado. Sierra flexible y universal para aceros e inoxidables.

Milled teeth and wavy set. Flexible and universal blade for steel and stainless steel.

Dents fraisés et ondulés. Lame flexible et universelle pour aciers et Inox.

Mod.	TPI	Diente Tooth Dent mm	L mm	I mm		Nº Art.	€ pack
00200	18	1,4	200	180	5	69004	25,99



Mod 00030

CORTE ACEROS, INOX, NO FERROSOS

Steel, Stainless, Non-Ferrous Cut
Coupe Aciers, Inox, Non ferreux



S922BF

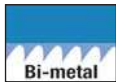

Dentado fresado y ondulado. Sierra flexible y universal para aceros, inoxidable y metales no ferrosos.

Milled teeth and wavy set. Flexible and universal blade for steel, stainless steel and non-ferrous metals.

Dents fraisés et ondulés. Lame flexible et universelle pour aciers, Inox et métaux non ferreux.

Mod.	TPI	Diente Tooth Dent mm	L mm	I mm		Nº Art.	€ pack
00030	14	1,8	150	130	5	18866	18,80



Mod 00210

CORTE LARGO ACEROS, INOX, NO FERROSOS

Steel, Stainless, Non-Ferrous Long Cut
Coupe longue Aciers, Inox, Non ferreux



S1122BF



Dentado fresado y ondulado. Sierra flexible y universal para aceros, inoxidable y metales no ferrosos.

Milled teeth and wavy set. Flexible and universal blade for steel, stainless steel and non-ferrous metals.

Dents fraisés et ondulés. Lame flexible et universelle pour aciers, Inox et métaux non ferreux.

Mod.	TPI	Diente Tooth Dent mm	L mm	I mm		Nº Art.	€ pack
00210	14	1,8	200	180	5	69005	24,75



Mod 00050

CORTE RECTO ANCHO ESPECIAL PALLETS

Pallet Special Thick Straight Cut
Coupe droite très grosse palettes



S1025VF

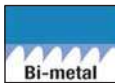

Dentado fresado, ondulado y variable. Ancho de sierra especial para corte recto en todo tipo de maderas con residuos de metales. Especial reparación de pallets.

Side set, wavy and variable toothing. Special thick blade for straight cutting of all wood types with few metal residues. Special for pallet repair.

Denture ondulé et variable. Lame très grosse pour coupe droite dans différents types de bois. Spécial pour réparation de palettes.

Mod.	TPI	Diente Tooth Dent mm	L mm	I mm		Nº Art.	€ pack
00050	10-14	2,5-1,8	200	180	5	18868	28,58



Mod 00220

CORTE ACEROS, INOX, NO FERROSOS

Steel, Stainless, Non-Ferrous Cut
Coupe Aciers, Inox, Non ferreux



S922HF



Dentado fresado y ondulado. Sierra flexible y universal para aceros, inoxidable y metales no ferrosos.

Milled teeth and wavy set. Flexible and universal blade for steel, stainless steel and non-ferrous metals.

Dents fraisés et ondulés. Lame flexible et universelle pour aciers, Inox et métaux non ferreux.

Mod.	TPI	Diente Tooth Dent mm	L mm	I mm		Nº Art.	€ pack
00220	10	2,5	150	130	5	69006	19,82



Mod 00230

CORTE LARGO ACEROS, INOX, NO FERROSOS

Steel, Stainless, Non-Ferrous Long Cut
Coupe longue Aciers, Inox, Non ferreux



S1122HF

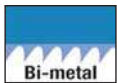

Dentado fresado y ondulado. Sierra flexible y universal para aceros, inoxidable y metales no ferrosos.

Milled teeth and wavy set. Flexible and universal blade for steel, stainless steel and non-ferrous metals.

Dents fraisés et ondulés. Lame flexible et universelle pour aciers, Inox et métaux non ferreux.

Mod.	TPI	Diente Tooth Dent mm	L mm	I mm		Nº Art.	€ pack
00230	10	2,5	200	180	5	69007	23,58



Mod 00240

CORTE ACEROS, INOX, NO FERROSOS

Steel, Stainless, Non-Ferrous Cut
Coupe Aciers, Inox, Non ferreux



S1211HF

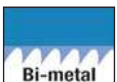

Dentado fresado y ondulado. Sierra flexible y universal para aceros, inoxidable y metales no ferrosos.

Milled teeth and wavy set. Flexible and universal blade for steel, stainless steel and non-ferrous metals.

Dents fraisés et ondulés. Lame flexible et universelle pour aciers, Inox et métaux non ferreux.

Mod.	TPI	Diente Tooth Dent mm	L mm	I mm		Nº Art.	€ pack
00240	10	2,5	280	260	5	69008	28,93



Mod 00260

CORTE FLEXIBLE LARGO ALTO RENDIMIENTO

Long Life Long Flexible Cut
Coupe flexible longue longue durée



S123XF

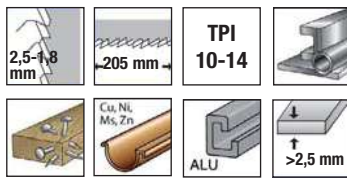
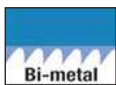
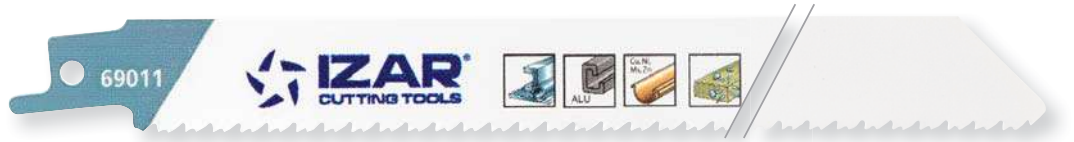

Dentado fresado y ondulado con geometría especial. Sierra flexible de alto rendimiento en metal y madera con residuos de metal.

Special geometry milled teeth and wavy set. High performance flexible blade for steel and wood with metal residues.

Dents fraisés et ondulés avec géométrie spéciale. Lame flexible, haut rendement dans aciers et bois.

Mod.	TPI	Diente Tooth Dent mm	L mm	I mm		Nº Art.	€ pack
00260	10-14	2,5-1,8	225	205	5	69011	29,50



Mod 00280

RESCATE Y DESMONTAJE CORTE LARGO

Long Cut Rescue & Dismantling
Secours et démantage coupe longue

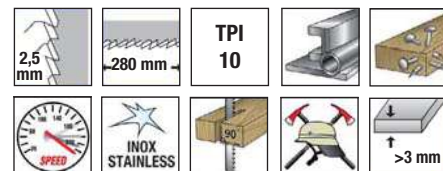

Dentado fresado y alterno. Sierra robusta con ancho especial para corte recto y rápido en acero, todo tipo de maderas con residuos de metal. Especial rescate y desmontaje.

Milled and side set teeth. Special thick and robust blade for fast and straight cutting of steel and all types of wood with metal residues. Especial for rescue and dismantling.

Dents fraisés et ondulés. Lame très épaisse pour coupe droite et rapide dans aciers et différents types de bois. Spéciale pour secours et démantages.

Mod.	TPI	Diente Tooth Dent mm	L mm	I mm		Nº Art.	€ pack
00280	10	2,5	300	280	5	69014	60,62



Mod 00020

REPARACIÓN PALLETS

Pallet Repair
Réparation de palettes



S922VF



Dentado fresado, ondulado y variable. Todo tipo de maderas con residuos de metales. Especial reparación de pallets.

Side set, wavy and variable tothing. All wood types with metal residues. Special for pallet repair.

Denture fraisée, ondulé et variable. Différents types de bois. Spéciale pour réparation de palettes.

Mod.	TPI	Diente Tooth Dent mm	L mm	I mm		Nº Art.	€ pack
00020	10-14	2,5-1,8	150	130	5	18874	20,64



Mod 00030

REPARACIÓN PALLETS CORTE LARGO

Long Cut Pallet Repair
Réparation de palettes coupe longue



S1122VF



Dentado fresado, ondulado y variable. Todo tipo de maderas con residuos de metales. Especial reparación de pallets.

Side set, wavy and variable tothing. All wood types with metal residues. Special for pallet repair.

Denture fraisée, ondulé et variable. Différents types de bois. Spéciale pour réparation de palettes.

Mod.	TPI	Diente Tooth Dent mm	L mm	I mm		Nº Art.	€ pack
00030	10-14	2,5-1,8	225	205	5	18875	25,73



Mod 00040

CORTE FLEXIBLE RECTO RÁPIDO ALTO RENDIMIENTO

Long Life Fast Straight Flexible Cut
Coupe flexible droite rapide longue durée

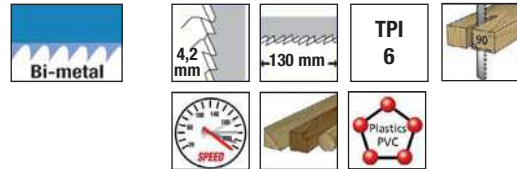

S611DF

Mod.	TPI	Diente Tooth Dent mm	L mm	I mm	📦	Nº Art.	€ pack
00040	6	4,2	150	130	5	18876	20,33



Dentado fresado y alternativo. Sierra flexible para corte recto y rápido en todo tipo de maderas y plásticos. Alto rendimiento.

Side set, milled teeth. Flexible blade for fast and straight cutting of all types of woods and plastics. Long lifetime.

Denture fraisée et avoyée. Lame flexible pour coupe droite et rapide dans différents types de bois et plastiques. Durée de vie plus longue.

Mod 00060

CORTE EXTRA LARGO FLEXIBLE RECTO RÁPIDO ALTO RENDIMIENTO

Long Life Fast Straight Flexible Extra Long Cut
Coupe extra longue flexible droite rapide longue durée

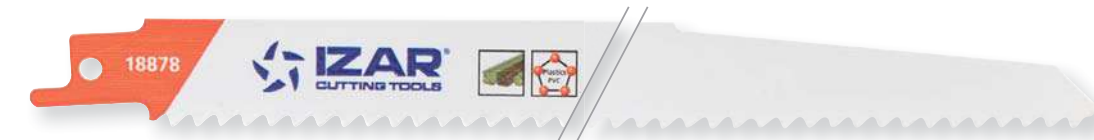

S1411DF

Mod.	TPI	Diente Tooth Dent mm	L mm	I mm	📦	Nº Art.	€ pack
00060	6	4,2	300	280	5	18878	33,48



Dentado fresado y alternativo. Sierra flexible para corte recto y rápido en todo tipo de maderas y plásticos. Alto rendimiento.

Side set, milled teeth. Flexible blade for fast and straight cutting of all types of woods and plastics. Long lifetime.

Denture fraisée et avoyée. Lame flexible pour coupe droite et rapide dans différents types de bois et plastiques. Durée de vie plus longue.



Mod 00200

DENTADO TUNGSTENO

Tungsten Teeth
Denture Tungstène



S1141HM

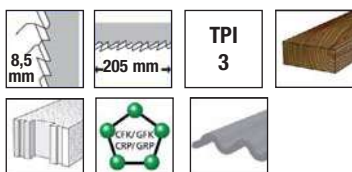

Dentado de tungsteno. Especial madera dura, hormigón poroso y productos reforzados con fibra de vidrio.

Side set, milled teeth. Special for hard wood, gas-formed concrete and glass-fibre reinforced products.

Denture fraisée et avoyée. Spéciale pour bois durs, bétons et matières plastiques renforcées avec fibres de verre.

Mod.	TPI	Diente Tooth Dent mm	L mm	I mm		Nº Art.	€ pack
00200	3	8,5	225	205	1	69017	40,43



Mod 00210

DENTADO TUNGSTENO CORTE LARGO

Long Cut Tungsten Teeth
Denture Tungstène coupe longue



S1241HM

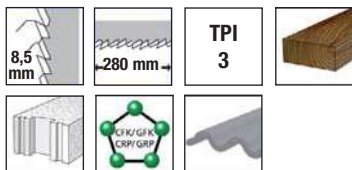

Dentado de tungsteno. Especial madera dura, hormigón poroso y productos reforzados con fibra de vidrio.

Side set, milled teeth. Special for hard wood, gas-formed concrete and glass-fibre reinforced products.

Denture fraisée et avoyée. Spéciale pour bois durs, bétons et matières plastiques renforcées avec fibres de verre.

Mod.	TPI	Diente Tooth Dent mm	L mm	I mm		Nº Art.	€ pack
00210	3	8,5	300	280	1	69019	47,09



Mod 00260

DEMOLICIÓN CORTE LARGO TCT

TCT Long Cut Demolition
Démolition coupe longue TCT



S1243HM



Dentado de tungsteno. Especial bloques de hormi-
gón poroso, ladrillo, fibrocemento.

Tungsten teeth. Special for aerated concrete
blocks, brick, fibre cement.

Denture Tungstène. Spécial pour blocs de béton
cellulaire, brique, amiante-ciment.

Mod.	TPI	Diente Tooth Dent mm	L mm	I mm		Nº Art.	€ pack
00260	2	12,7	305	250	1	72626	45,71



Mod 00270

DEMOLICIÓN CORTE EXTRA LARGO TCT

TCT Extra Long Cut Demolition
Démolition coupe extra longue TCT



S2243HM



Dentado de tungsteno. Especial bloques de hormi-
gón poroso, ladrillo, fibrocemento.

Tungsten teeth. Special for aerated concrete
blocks, brick, fibre cement.

Denture Tungstène. Spécial pour blocs de béton
cellulaire, brique, amiante-ciment.

Mod.	TPI	Diente Tooth Dent mm	L mm	I mm		Nº Art.	€ pack
00270	2	12,7	455	400	1	72627	55,85



Mod 00220

HIELO Y COMIDA CONGELADA

Ice & Frozen Food
Glaces et produits surgelés



S1211K



Dentado fresado y alterno de acero inoxidable. Especial comida congelada, hielo y madera.

Side set, milled teeth. Special for frozen food, ice and wood.

Denture fraisée et avoyée. Spéciale pour produits surgelés, glaces et bois.

Mod.	TPI	Diente Tooth Dent mm	L mm	I mm		Nº Art.	€ pack
00220	4	6,35	300	280	1	69020	21,88



Mod 00240

CORTE RÁPIDO MUY LIMPIO AISLAMIENTO

Insulation Very Clean Fast Cut
Coupe rapide très propre isolant



S1213AWP



HCS / CV



Dentado ondulado doble. Corte rápido y muy limpio en lana de roca, espuma, poliestireno, cuero, caucho, papel, cartón, alfombra.

Side set, milled teeth. Fast and very clean cutting of mineral rock wool, foam, polystyrene, rubber, paper, carton, carpet.

Denture fraisée et avoyée. Coupe rapide et très précise dans mousses, polystyrène, cuirs, caoutchouc, papiers, cartons, tapis.

Mod.	L mm	I mm		Nº Art.	€ pack
00240	300	280	5	69024	45,04



Mod 00300

MANGO MULTIHERRAMIENTA

Multi Tool Handle
Queue multi-outils



HCS / CV

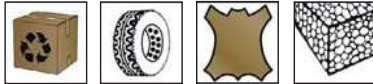

Espuma / Poliestireno
Foam / Polystyrene
Mousse / Polystyrène

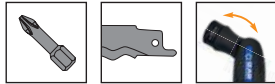

MANGO MULTIHERRAMIENTA 2 en 1: atornillar y serrar

- Mango inclinable, facilita la transmisión de la fuerza
- Para lugares de difícil acceso
- Apto para sierras de sable y puntas de atornillar estándar
- Depósito para 6 puntas de atornillos (no incluidas)
- Fácil cambio de herramienta gracias a su anillo de montaje giratorio.
- Apto para uso manual en madera con Ref. 1950 mod. 00020, en metal con Ref. 1920 mod. 00200, en aislamiento y otros materiales con Ref. 1960 mod. 00240 y mod. 00280.

MULTITOOL HANDLE 2 in 1: screw and saw

- Inclinable handle for better power transmission
- Useful at places which are difficult to Access/reach
- Suitable for reciprocating saw blades and standard screw bits
- Bit magazine for 6 bits (not included)
- Easy tool change by means of a/its rotating mounting ring
- Suitable for manual use in wood with Ref. 1950 mod. 00020, in metal with Ref. 1920 mod. 00200 and in insulation and other materials with Ref. 1960 mod. 00240 and mod. 00280.

QUEUE MULTI-OUTILS 2 en 1: viser et serrer

- Queue réclinable: il rend plus facile la transmission des forces
- Pour des endroits de difficile accès
- Convenable pour scies sabres et embouts standards
- Capacité 6 embouts (pas compris)
- Changement d'outil facile grace à sa bague de montage rotative
- Conseillé pour utilisation à main en bois avec ref. 1950 mod. 00020, en métal avec ref. 1920 mod. 00200, en isolation et autres matériaux avec mod. 00240 et mod. 00280.

Mod.	Cont.		Nº Art.	€ pack
00300	1 x Mango / Handle / Queue 1 x Ref. 1960 - 00240 (Art. 69024) l=280 S1213AWP 1 x Ref. 1960 - 00280 (Art. 76688) l=205 S1113AWP	1	72851	47,64

Línea 1 m 19SS - Refs. 1920 - 1950 - 1960

SIERRAS SABLE
Sabre Saw Blades
Lames scie sabre



Ref.	1920	1920	1920	1950	1950	1950	1960	1960	1960	1960
	00020	00030	00050	00010	00020	00030	00020	00030	00040	00060
Pcs	3	3	3	3	3	3	3	3	3	3

Ref. 4995 - Nº Art. 72191: 689,40 €



CUADRO USO SIERRAS CALAR

Jig Saw Blade Use Table

Tableau utilisation lames scies sauteuses

● **Ideal**
● **Ideal - Idéal**

○ **Adecuado**
○ **Suitable - Convenable**

MADERA - Wood - Bois

Todos tipos
All types
Toutes sortes

Agglomerado lami-
nado
Laminated chipboard
Panneau revêtu

Blanda
Soft
Tendre

Dura
Hard
Dur

Contrachapado
Plywood
Contreplaqué

Parquet laminado
Laminated parquet
Parquet lamifié

Con clavos
With nails
Avec clous

Agglomerado
Chipboard
Panneau

Plásticos
Plastics
Plastiques

Reforzados
fibra carbon
Carbon fibre
Reinforced
fibre-carbone

Madera Wood - Bois	Ref. - Mod.	Equiv.	Mat.	TPI	l mm	Pág.															
	1940	010	T119B	HCS/CV	13	50	398														
	020	T119BO	HCS/CV	13	50	398															
	030	T111C	HCS/CV	8,5	75	399															
	040	T144D	HCS/CV	6,35	75	399	●			●											
	050	T244D	HCS/CV	6,35	75	400	●			●											
	060	T101B	HCS/CV	10	75	400	●			●											
	070	T101BR	HCS/CV	10	75	401	●			●											
	080	T101D	HCS/CV	6,35	75	401	●			●											
	090	T301CD	HCS/CV	8,5	105	402	●			●											
	100		HCS/CV	10	75	402			●	●				●							
	110	T144DF	Bi-metal	6,35	75	403	●			●											
	130	T344D	HCS/CV	6,35	105	403	●			●											
	140	T234X	Bi-metal	10	91	404	●			●											
	150	T345XF	Bi-metal	10-14	105	404	○			○											
	160		HCS/CV	6,35	75	405	●			●											
	170	T308BCP	HCS/CV	13	105	405			●	●											
	180	T301B	HCS/CV	10	91	406	●			●											
	200	T744D	HCS/CV	6,35	155	406	●			●											

Metal Metal - Métal	Ref. - Mod.	Equiv.	Mat.	TPI	l mm	Pág.																
	1910	020	T118A	HSS	21	55	407															
		040	T318A	HSS	25	105	407															
		050	T118B	HSS	13	55	408															
		060	T318B	HSS	14	105	408															
		070	T118AF	Bi-metal	21	55	409															
		090	T118BF	Bi-metal	13	55	409															
		100	T318BF	Bi-metal	14	105	410															
		110	T127D	HSS	8,5	75	410															
		120	T118AHM	CV-HM	23	50	411															

Especial Special	Ref. - Mod.	Equiv.	Mat.	TPI	l mm	Pág.																
	1930	020	T127DF	Bi-metal	8,5	75	412															
		030	T130RIFF	CV-HM		54	412															

Madera Wood - Bois	Ref. - Mod.	Equiv.	Mat.	TPI	l mm	Pág.																
	1945	00030	U111C	HCS/CV	8,5	75	413															
		00040	U144D	HCS/CV	6,35	75	413	●			●											
		00060	U101B	HCS/CV	10	75	414	●			●											

Metal Metal	Ref. - Mod.	Equiv.	Mat.	TPI	l mm	Pág.																
	1915	00020	U118A	HSS	21	55	415															
		00070	U118AF	Bi-metal	21	55	415															



SIERRAS CALAR

Jig Saw Blades

Lames scies sauteuses

Ref. **1940**

MADERA Wood Bois

Mod **010**

BÁSICA CORTE RECTO

Basic Straight Cut
Basique coupe droite

T119B

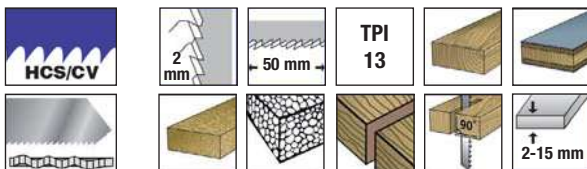

Mod.	TPI	Diente Tooth Dent mm	L mm	I mm		Nº Art.	€ pack
010	13	2	76	50	3	14129	2,72

Dentado fresado y ondulado. Corte recto y limpio en madera blanda, madera contrachapada, tabla de viruta prensada, madera estratificada, tablero de fibra y materiales de aislamiento.

Milled teeth and wavy set. Straight and clean cutting of soft wood, plywood, chipboard, wood core plywood, fibre board and insulation materials.

Dents fraisés et ondulés. Coupe droite et propre dans bois tendres, contre-plaqués, agglomérés, fibres et matériaux d'isolation.



Mod **020**

BÁSICA CORTE CURVO

Basic Curve Cut
Basique coupe courbe

T119BO

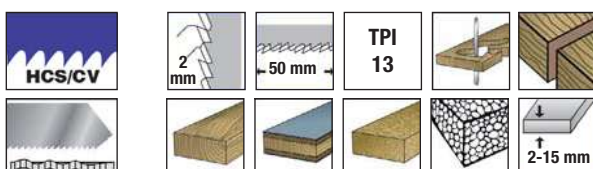

Mod.	TPI	Diente Tooth Dent mm	L mm	I mm		Nº Art.	€ pack
020	13	2	76	50	3	14138	3,87

Dentado fresado y ondulado. Corte curvo y limpio en madera blanda, madera contrachapada, tabla de viruta prensada, madera estratificada, tablero de fibra y materiales de aislamiento.

Milled teeth and wavy set. Curve and clean cutting of soft wood, plywood, chipboard, wood core plywood, fibre board and insulation materials.

Dents fraisés et ondulés. Coupe courbe et propre dans bois tendres, contre-plaqués, agglomérés, fibres et matériaux d'isolation.



Mod 030

BÁSICA CORTE BASTO

Basic Rough Cut
Basique coupe gros



T111C

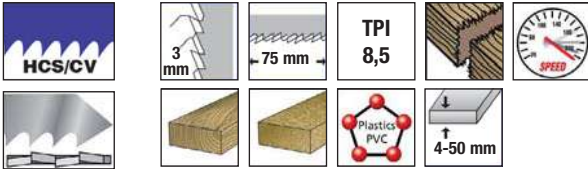

Dentado alterno. Corte basto y rápido en madera blanda, tabla de viruta prensada, madera estratificada, tablero de fibra y plástico.

Side set toothing. Rough and fast cutting of soft wood, chipboard, wood core plywood, fibre board and plastics.

Denture avoyée et affûtée. Coupe grosso et rapide dans bois tendres, agglomérés, fibres et plastiques.

Mod.	TPI	Diente Tooth Dent mm	L mm	I mm	№ Art.	€ pack
030	8,5	3	100	75	3 14221	2,80



Mod 040

CORTE RÁPIDO

Fast Cut
Coupe rapide



T144D

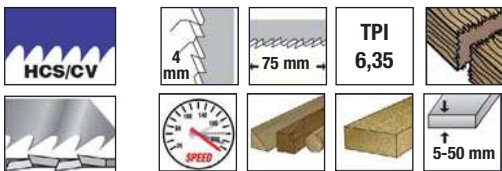

Dentado alterno y afilado diagonal. Corte rápido en todo tipo de maderas.

Side set and diagonally sharpened toothing. Fast cutting for all wood types.

Denture avoyée, dépouillée et affûtée. Coupe rapide dans différents types de bois.

Mod.	TPI	Diente Tooth Dent mm	L mm	I mm	№ Art.	€ pack
040	6,35	4	100	75	3 14230	4,08



Mod 050

CORTE RÁPIDO CURVO

Curve Fast Cut
Coupe rapide courbe

T244D

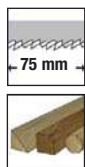
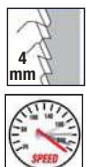

Dentado alterno y afilado diagonal. Corte rápido y curvo en todo tipo de maderas.

Side set and diagonally sharpened toothing. Fast and curve cutting for all wood types.

Denture avoyée, dépouillée et affûtée. Coupe rapide et courbe dans différents types de bois.



Mod.	TPI	Diente Tooth Dent mm	L mm	I mm	Nº Art.	€ pack
050	6,35	4	100	75	3 14231	4,65

Mod 060

CORTE LIMPIO

Clean Cut
Coupe propre

T101B

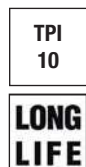
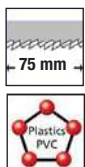
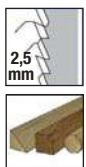

Sierra rectificación cónica y dentado afilado diagonal. Corte limpio en todo tipo de maderas y plásticos.

Conically ground blade with diagonally sharpened teeth. Clean cutting for all wood types and plastics.

Corps de la lame conique et denture dépouillée et affûtée. Coupe propre dans différents types de bois et plastiques.



Mod.	TPI	Diente Tooth Dent mm	L mm	I mm	Nº Art.	€ pack
060	10	2,5	100	75	3 14233	4,68



Mod 070

CORTE LIMPIO SIN ASTILLAS

Splinterfree Clean Cut
Coupe propre sans éclat



T101BR



Sierra rectificado cónico y dentado afilado diagonal. Dentado inverso. Corte limpio sin astillas en todo tipo de maderas y plásticos.

Conically ground blade with diagonally sharpened teeth. Reverse teeth. Clean splinterfree cutting for all wood types and plastics.

Corps de la lame conique et denture dépouillée et affûtée. Denture inversée. Coupe propre sans éclats dans différents types de bois et plastiques.

Mod.	TPI	Diente Tooth mm	Dent mm	L mm	I mm	Nº Art.	€ pack
070	10	2,5		100	75	3 14236	5,77



Mod 080

CORTE LIMPIO RÁPIDO

Fast Clean Cut
Coupe propre rapide



T101D

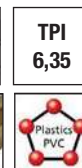
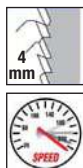

Sierra rectificado cónico y dentado afilado diagonal. Corte limpio y rápido en todo tipo de maderas y plásticos.

Conically ground blade with diagonally sharpened teeth. Clean and fast cutting for all wood types and plastics.

Corps de la lame conique et denture dépouillée et affûtée. Coupe propre et rapide dans différents types de bois et plastiques.

Mod.	TPI	Diente Tooth mm	Dent mm	L mm	I mm	Nº Art.	€ pack
080	6,35	4		100	75	3 14243	4,68



Mod 100

CORTE LIMPIO CURVO

Curve Clean Cut
Coupe propre courbe

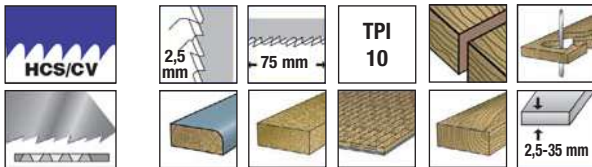

Sierra rectificado cónico y dentado afilado diagonal. Corte limpio y curvo en madera blanda, aglomerado, laminado, parqué.

Conically ground blade with diagonally sharpened teeth. Clean and curve cutting for soft wood, chipboard, laminated board, parquett.

Corps de la lame conique et denture dépouillée et affûtée. Coupe propre et courbe dans bois tendres, agglomérés, panneaux en bois, parquets.

Mod.	TPI	Diente Tooth Dent mm	L mm	I mm		Nº Art.	€ pack
100	10	2,5	100	75	3	14302	6,42



Mod 090

CORTE LIMPIO LARGO

Long Clean Cut
Coupe propre longue



T301CD

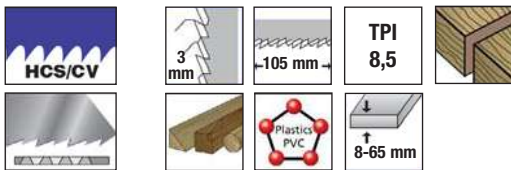

Sierra rectificado cónico y dentado afilado diagonal. Corte limpio y largo en todo tipo de maderas y plásticos.

Conically ground blade with diagonally sharpened teeth. Clean and long cutting for all wood types and plastics.

Corps de la lame conique et denture dépouillée et affûtée. Coupe propre et longue dans différents types de bois et plastiques.

Mod.	TPI	Diente Tooth Dent mm	L mm	I mm		Nº Art.	€ pack
090	8,5	3	132	105	3	14246	6,11



Mod 110

CORTE RÁPIDO ALTO RENDIMIENTO

Long Life Fast Cut
Coupe rapide longue durée

T144DF

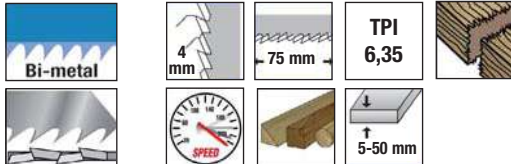

Dentado alterno y afilado diagonal. Corte rápido en todo tipo de maderas. Alto rendimiento.

Side set and diagonally sharpened toothing. Fast cutting for all wood types. Long lifetime.

Denture avoyée, dépouillée et affûtée. Coupe rapide dans différents types de bois. Durée de vie plus longue.

Mod.	TPI	Diente Tooth Dent mm	L mm	I mm		Nº Art.	€ pack
110	6,35	4	100	75	3	14306	8,12

Mod 130

CORTE RÁPIDO LARGO

Long Fast Cut
Coupe rapide longue

T344D

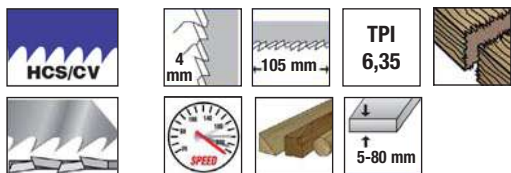

Dentado alterno y afilado diagonal. Corte rápido y largo en todo tipo de maderas.

Side set and diagonally sharpened toothing. Fast and long cutting for all wood types.

Denture avoyée, dépouillée et affûtée. Coupe rapide et longue dans différents types de bois.

Mod.	TPI	Diente Tooth Dent mm	L mm	I mm		Nº Art.	€ pack
130	6,35	4	132	105	3	14307	5,06



Mod 140

CORTE LIMPIO RÁPIDO

Fast Clean Cut
Coupe propre rapide



T234X

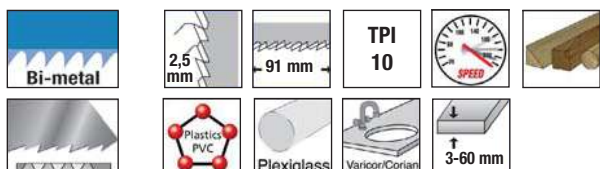

Sierra rectificado cónico y dentado afilado triple. Corte limpio y rápido en todo tipo de maderas y plásticos.

Conically ground blade with 3-times sharpened teeth. Clean and fast cutting for all wood types and plastics.

Corps de la lame conique avec denture affûtée triple. Coupe propre et rapide dans différents types de bois et plastiques.

Mod.	TPI	Diente Tooth Dent mm	L mm	I mm		Nº Art.	€ pack
140	10	2,5	117	91	3	14326	9,34



Mod 150

CORTE LARGO FLEXIBLE ALTO RENDIMIENTO

Long Life Flexible Long Cut
Coupe longue flexible longue durée



T345XF

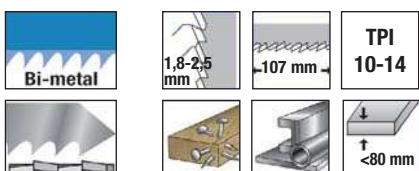

Dentado fresado alterno. Sierra larga y flexible para madera con residuos de metal, tubos y perfiles de acero (2,5-10 mm). Gran rendimiento.

Milled and side teeth. Long and flexible blade for wood with metal residues, steel pipes and profiles (2,5-10 mm). Long lifetime.

Dents fraisés et avoyés. Lame très longue et flexible pour bois avec métaux résiduels, tubes et profils en acier (2,5-10 mm). Durée de vie plus longue.

Mod.	TPI	Diente Tooth Dent mm	L mm	I mm		Nº Art.	€ pack
150	10-14	1,8-2,5	132	107	3	14327	11,43

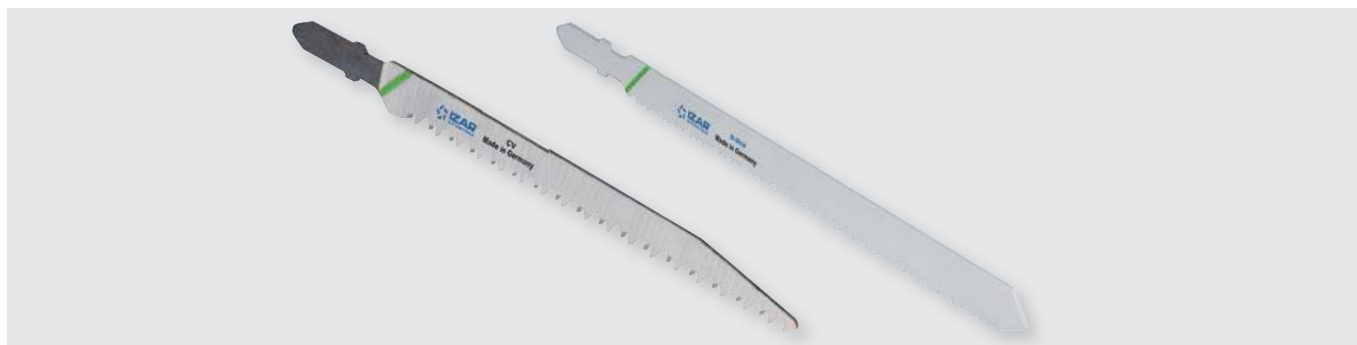

Mod 160

CORTE RÁPIDO CURVO

Curve Fast Cut
Coupe rapide courbe

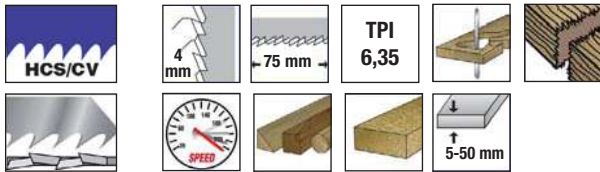

Dentado doble avoyée y afilado diagonal. Corte rápido y curvo en todo tipo de maderas.

Double side set and diagonally sharpened tooting. Fast and curve cutting for all wood types.

Denture double avoyée, dépouillée et affûtée. Coupe rapide et courbe dans différents types de bois.

Mod.	TPI	Diente Tooth Dent mm	L mm	I mm	3	Nº Art.	€ pack
160	6,35	4	100	75	3	14328	12,22



Mod 170

CORTE LIMPIO RÁPIDO

Fast Clean Cut
Coupe propre rapide

T308BCP

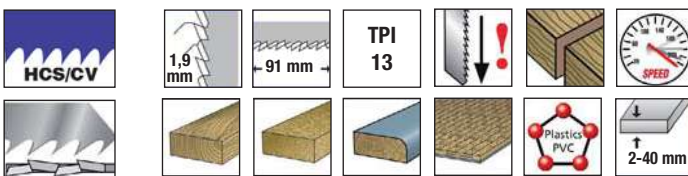

Sierra rectificadno cónico y dentado afilado inverso. Corte limpio y rápido en madera blanda, aglomerado, tablero de fibra, laminado, parqué, laminado plástico.

Conically ground blade with reverse sharpened teeth. Clean and fast cutting for all wood types and plastics.

Corps de la lame conique denture renversée et affûtée. Coupe propre et rapide dans différents types de bois et plastiques.

Mod.	TPI	Diente Tooth Dent mm	L mm	I mm	3	Nº Art.	€ pack
170	13	1,9	117	91	3	14331	5,05



Mod 180

CORTE LIMPIO

Clean Cut
Coupe propre



T301B



TPI 10

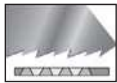

3-65 mm

Sierra rectificado cónico y dentado afilado diagonal. Corte limpio en todo tipo de maderas y plásticos.

Conically ground blade with diagonally sharpened teeth. Clean cutting for all wood types and plastics.

Corps de la lame conique denture dépouillée et affûtée. Coupe propre dans différents types de bois et plastiques.

Mod.	TPI	Diente Tooth Dent mm	L mm	I mm		Nº Art.	€ pack
180	10	2,5	132	105	3	14332	8,44



Mod 200

CORTE RÁPIDO MUY LARGO

Very Long Fast Cut
Coupe rapide très longue



T744D



TPI 6,35



5-120 mm

Dentado alterno y afilado diagonal. Corte rápido y muy largo en todo tipo de maderas.

Side set and diagonally sharpened toothing. Fast and very long cutting for all wood types.

Denture avoyée, dépouillée et affûtée. Coupe rapide et très longue dans différents types de bois.

Mod.	TPI	Diente Tooth Dent mm	L mm	I mm		Nº Art.	€ pack
200	6,35	4	180	155	3	14334	9,06



Mod 020

CORTE LÁMINAS FINAS ACERO

Thin Steel Sheet Cut
Coupe tôles fines acier



T118A



TPI
21

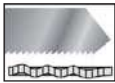

1,2-2 mm

Dentado fresado y ondulado. Láminas finas de acero.

Milled teeth and wavy set. Thin steel sheets.

Dents fraisés et ondulés. Tôles fines.

Mod.	TPI	Diente Tooth Dent mm	L mm	I mm		Nº Art.	€ pack
020	21	1,2	76,5	55	3	14336	4,67

Mod 040

CORTE LARGO LÁMINAS FINAS ACERO

Thin Steel Sheet Long Cut
Coupe longue tôles fines acier



T318A

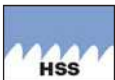

TPI
25



1-3 mm

Dentado fresado y ondulado. Sierra larga para láminas finas de acero, tubos, perfiles y material tipo sandwich hasta 80 mm.

Milled teeth and wavy set. Long blade for thin steel sheets, pipes, profiles and sandwich-material up to 80 mm.

Dents fraisés et ondulés. Lame longue pour tôles fines, profils, tubes et matériel sandwich jusqu'à 80 mm.

Mod.	TPI	Diente Tooth Dent mm	L mm	I mm		Nº Art.	€ pack
040	25	1	132	105	3	14339	7,68



Mod 050

CORTE ACEROS, NO FERROSOS, ALUMINIO

Steel, Non-Ferrous, Aluminium Cut
Coupe Aciers, Non ferreux, Aluminium



T118B

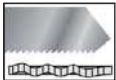
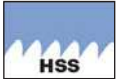

Dentado fresado y ondulado. Aceros, metales no ferrosos y aluminio.

Milled teeth and wavy set. Steel, non-ferrous metal and aluminium.

Dents fraisés et ondulés. Aciers, métaux non ferreux et aluminiums.



Mod.	TPI	Diente Tooth Dent mm	L mm	I mm		Nº Art.	€ pack
050	13	2	76,5	55	3	14349	4,67

Mod 060

CORTE LARGO FLEXIBLE

Flexible Long Cut
Coupe longue flexible



T318B



Dentado fresado y ondulado. Sierra larga y flexible para aceros, tubos, perfiles, material tipo sandwich hasta 80 mm y metales no ferrosos. Alto rendimiento.

Milled teeth and wavy set. Long and flexible blade for steel, pipes, profiles, sandwich-material up to 80 mm and non-ferrous metals. Long life.

Dents fraisés et ondulés. Lame longue et flexible pour aciers, profils, tubes, matériel sandwich jusqu'à 80 mm et métal non ferreux. Durée de vie plus longue.



Mod.	TPI	Diente Tooth Dent mm	L mm	I mm		Nº Art.	€ pack
060	14	1,8	132	105	3	14351	7,12



Mod 070

CORTE FLEXIBLE ALTO RENDIMIENTO

Long Life Flexible Cut
Coupe flexible longue durée



T118AF



Dentado fresado y ondulado. Sierra flexible para aceros e inoxidable. Alto rendimiento.

Milled teeth and wavy set. Flexible blade for steel and stainless steel. Long life.

Dents fraisés et ondulés. Lame longue et flexible pour aciers et inoxydables. Durée de vie plus longue.

Mod.	TPI	Diente		L	l	Icon	Nº Art.	€ pack
		Tooth	Dent	mm	mm			
		mm	mm					
070	21	1,2		76,5	55	3	14352	6,06

Mod 090

CORTE FLEXIBLE ALTO RENDIMIENTO

Long Life Flexible Cut
Coupe flexible longue durée



T118BF

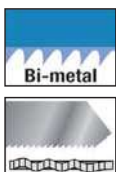

Dentado fresado y ondulado. Sierra flexible para aceros e inoxidable, metales no ferrosos y aluminio. Alto rendimiento.

Milled teeth and wavy set. Flexible blade for steel and stainless steel, non-ferrous metals and aluminium. Long life.

Dents fraisés et ondulés. Lame longue et flexible pour aciers et inoxydables, métaux non ferreux et aluminium. Durée de vie plus longue.

Mod.	TPI	Diente		L	l	Icon	Nº Art.	€ pack
		Tooth	Dent	mm	mm			
		mm	mm					
090	13	2		76,5	55	3	14353	6,06



Mod 100

CORTE LARGO FLEXIBLE ALTO RENDIMIENTO

Long Life Flexible Long Cut
Coupe longue flexible longue durée



T318BF

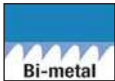

Dentado fresado y ondulado. Sierra larga y flexible para aceros, tubos, perfiles, material tipo sandwich hasta 80 mm y metales no ferrosos. Alto rendimiento.

Milled teeth and wavy set. Long and flexible blade for steel, pipes, profiles, sandwich-material up to 80 mm and non-ferrous metals. Long life.

Dents fraisés et ondulés. Lame longue et flexible pour aciers, profils, tubes, matériel sandwich jusqu'à 80 mm et métaux non ferreux. Durée de vie plus longue.

Mod.	TPI	Diente Tooth Dent mm	L mm	I mm		Nº Art.	€ pack
100	14	1,8	132	105	3	14358	11,05



Mod 110

CORTE ACEROS, NO FERROSOS, ALUMINIO, PLÁSTICO

Steel, Non-Ferrous, Aluminium, Plastic Cut
Coupe Aciers, Non ferreux, Aluminium, Plastique



T127D

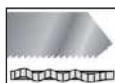
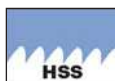

Dentado fresado alterno. Aceros, metales no ferrosos, aluminio y plásticos.

Milled teeth and side set. Steel, non-ferrous metals, aluminium and plastics.

Dents fraisés et avoyés. Aciers, métaux non ferreux, aluminiums et plastiques.

Mod.	TPI	Diente Tooth Dent mm	L mm	I mm		Nº Art.	€ pack
110	8,5	3	100	75	3	14372	5,81



Mod 120

METAL DURO PULVERIZADO

Grinded Carbide
Carbure pulvérisé



T118AHM



Banda de metal duro pulverizado. Aceros, planchas de metal e inoxidables.

Grinded carbide strip. Steel, metal sheets and stainless steel.

Dents en carbure. Aciers, tôles et aciers inoxydables.

Mod.	TPI	Diente Tooth mm	Dent mm	L mm	I mm	Nº Art.	€ pack
120	23	1,1	79	50	1	14379	17,99



Mod 200

CORTE LARGO FLEXIBLE CONSTRUCCIÓN ALTO RENDIMIENTO

Long Life Construction Flexible Long Cut
Coupe longue flexible construction longue durée



T718AF

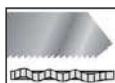

Dentado fresado y ondulado. Sierra larga y flexible para construcción de fachadas y material tipo sandwich. Alto rendimiento.

Milled teeth and wavy set. Long and flexible blade for facade construction and sandwich-material. Long life.

Dents fraisées et ondulés. Lame longue et flexible pour les façades et matériel sandwich. Durée de vie plus longue

Mod.	TPI	Diente Tooth mm	L mm	I mm	Nº Art.	€ pack
200	12	2	180	155	3	14380 13,35



Mod 020

CORTE FLEXIBLE METAL, PLÁSTICO

Plastic, Metal Flexible Cut
Coupe flexible Métal, Plastique

T127DF

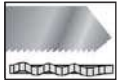
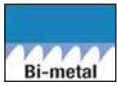

Mod.	TPI	Diente Tooth Dent mm	L mm	I mm		Nº Art.	€ pack
020	8,5	3	100	75	3	14386	7,96

Dentado fresado alterno. Sierra flexible para aceros, metales no ferrosos, aluminio (3-15 mm) y plásticos (3-30 mm).

Milled teeth and side set. Flexible blade for steel, non-ferrous metals, aluminium (3-15 mm) and plastics (3-30 mm).

Dents fraisés et avoyés. Lame flexible pour aciers, métaux non ferreux, aluminiums (3-15 mm) et plastiques (3-30 mm).



Mod 030

CORTE VIDRIO, CERÁMICA

Ceramic, Glass Cut
Coupe Verre, Céramique

T130RIFF



Mod.	L mm	I mm		Nº Art.	€ pack
030	79	54	1	14387	4,30

Recubrimiento de metal duro de grano grueso. Vidrio, cerámica y productos reforzados con fibra de vidrio.

Carbide coated, coarse-grained. Glass, ceramics, glass-fibre reinforced products.

Revêtement en carbure, gros grains. Verre, céramique, fibre de verre.



Mod 200

DENTADO METAL DURO TUNGSTENO

Tungsten Carbide Teeth
Denture carbure Tungstène

T341HM



Mod.	TPI	Diente Tooth Dent mm	L mm	I mm		Nº Art.	€ pack
200	6	4,2	132	100	1	14390	12,48

Dentado metal duro tungsteno. Fibra de vidrio, madera dura y hormigón gaseoso.

Carbide coated, coarse-grained. Glass-fibre, hard wood and gas formed concrete.

Revêtement en carbure, gros grains. Fibre de verre, bois durs et béton.



Mod 00030

BÁSICA CORTE BASTO RÁPIDO

Basic Fast Rough Cut
Basique coupe gros rapide



U111C

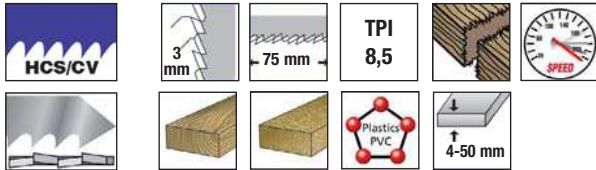

Dentado alterno. Corte basto y rápido en madera blanda, tabla de viruta prensada, madera estratificada, tablero de fibra y plástico.

Side set toothing. Rough and fast cutting of soft wood, chipboard, wood core plywood, fibre board and plastics.

Denture avoyée et affûtée. Coupe grosse et rapide dans bois tendres, agglomérés, fibres et plastiques.

Mod.	TPI	Diente Tooth Dent mm	L mm	I mm		Nº Art.	€ pack
00030	8,5	3	100	75	5	21883	5,34



Hasta fin de existencias / While stock lasts / Jusqu'à la fin de stock

Mod 00040

CORTE RÁPIDO

Fast Cut
Coupe rapide



U144D

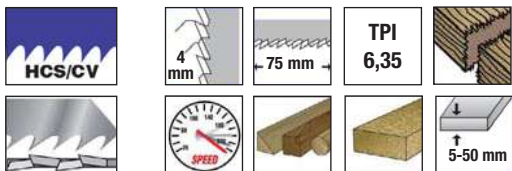

Dentado alterno y afilado diagonal. Corte rápido en todo tipo de maderas.

Side set and diagonally sharpened toothing. Fast cutting for all wood types.

Denture avoyée, dépouillée et affûtée. Coupe rapide dans différents types de bois.

Mod.	TPI	Diente Tooth Dent mm	L mm	I mm		Nº Art.	€ pack
00040	6,35	4	100	75	5	21884	7,43



Mod 00060

CORTE LIMPIO

Clean Cut
Coupe propre



U101B



Sierra rectificado cónico y dentado afilado diagonal. Corte limpio en todo tipo de maderas y plásticos.

Conically ground blade with diagonally sharpened teeth. Clean cutting for all wood types and plastics.

Corps de la lame conique et denture dépouillée et affûtée. Coupe propre dans différents types de bois et plastiques.

Mod.	TPI	Diente Tooth Dent mm	L mm	I mm		Nº Art.	€ pack
00060	10	2,5	100	75	5	21885	8,77



Mod 00070

CORTE LIMPIO SIN ASTILLAS

Splinterfree Clean Cut
Coupe propre sans éclat



U101BR

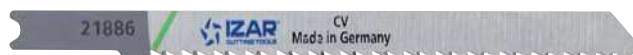

Sierra rectificado cónico y dentado afilado diagonal. Dentado inverso. Corte limpio sin astillas en todo tipo de maderas y plásticos.

Conically ground blade with diagonally sharpened teeth. Reverse teeth. Clean splinterfree cutting for all wood types and plastics.

Corps de la lame conique et denture dépouillée et affûtée. Denture inversée. Coupe propre sans éclats dans différents types de bois et plastiques.

Mod.	TPI	Diente Tooth Dent mm	L mm	I mm		Nº Art.	€ pack
00070	10	2,5	100	75	5	21886	8,77



Mod 00020

CORTE LÁMINAS FINAS ACERO

Thin Steel Sheet Cut
Coupe tôles fines acier



U118A

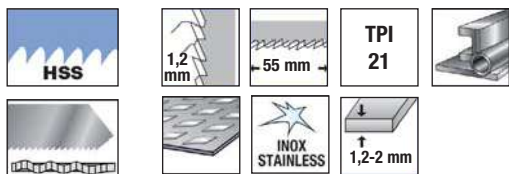

Dentado fresado y ondulado. Láminas finas de acero e inoxidable.

Milled teeth and wavy set. Thin steel and stainless steel sheets.

Dents fraisés et ondulés. Tôles fines en acier et inoxyable.

Mod.	TPI	Diente Tooth Dent mm	L mm	I mm	📦	Nº Art.	€ pack
00020	21	1,2	76,5	55	5	21892	8,88

Hasta fin de existencias / While stock lasts / Jusqu'à la fin de stock



Mod 00070

CORTE FLEXIBLE ALTO RENDIMIENTO

Long Life Flexible Cut
Coupe flexible longue durée



U118AF

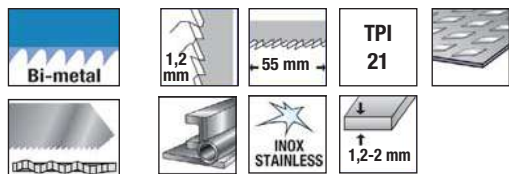

Dentado fresado y ondulado. Sierra flexible para aceros e inoxidable. Alto rendimiento.

Milled teeth and wavy set. Flexible blade for steel and stainless steel. Long life.

Dents fraisés et ondulés. Lame longue et flexible pour aciers et inoxyables. Durée de vie plus longue.

Mod.	TPI	Diente Tooth Dent mm	L mm	I mm	📦	Nº Art.	€ pack
00070	21	1,2	76,5	55	5	21893	13,47



Mod 00110

CORTE ACEROS, NO FERROSOS, ALUMINIO, PLÁSTICO

Steel, Non-Ferrous, Aluminium, Plastic Cut
Coupe Aciers, Non ferreux, Aluminium, Plastique



U127D

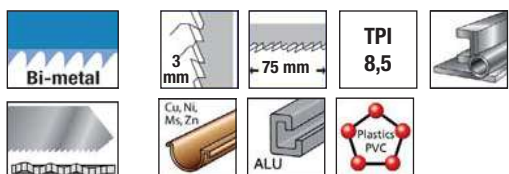

Dentado fresado alterno. Aceros, metales no ferrosos, aluminio y plásticos.

Milled teeth and side set. Steel, non-ferrous metals, aluminium and plastics.

Dents fraisés et avoyés. Aciers, métaux non ferreux, aluminiums et plastiques.

Mod.	TPI	Diente Tooth Dent mm	L mm	I mm	📦	Nº Art.	€ pack
00110	8,5	3	100	75	5	21894	11,64



Línea 1 m 19C1 - Refs. 1910 - 1930 - 1940

SIERRAS CALAR INSERCIÓN "T"

"T" Insertion Jig Saw Blades - Lames scies insertion "T"

23
cm



Ref.	1910	1910	1910	1910	1910	1910	1910	1910	1910	1930	1930	1940	1940	1940	1940	1940	1940	1940	1940
	020	040	050	060	070	090	100	110	020	030	010	020	030	040	050	060	070	080	100
Pcs	5	5	5	5	5	5	5	5	5	5	5	5	5	5	5	5	5	5	5

Ref. 4995 - N° Art. 72195: 525,25 €

Línea 1 m 19C2 - Refs. 1910 - 1915 - 1940 - 1945

SIERRAS CALAR INSERCIÓN "T" + "U"

"T" + "U" Insertion Jig Saw Blades - Lames scies insertion "T" + "U"

24
cm



Ref.	1910	1910	1910	1910	1910	1915	1915	1940	1940	1940	1940	1940	1940	1940	1940	1945	1945	1945	1945
	020	040	050	070	100	00070	00110	010	030	040	060	070	080	100	140	00030	00040	00060	00070
Pcs	5	5	5	5	5	5	5	5	5	5	5	5	5	5	5	5	5	5	5

Ref. 4995 - N° Art. 72196: 650,20 €

Display 20 - Refs. 1940 - 1930 - 1910

SIERRAS CALAR INSERCIÓN "T"

"T" Insertion Jig Saw Blades - Lames scies insertion "T"



Ref. 1940								
Mod.	Mod. 010	Mod. 020	Mod. 030	Mod. 030	Mod. 040	Mod. 040	Mod. 050	Mod. 060
Pcs	3	3	2	1	2	1	3	2
Ref. 1940						Ref. 1930		
Mod.	Mod. 060	Mod. 070	Mod. 070	Mod. 080	Mod. 100	Mod. 020	Mod. 030	Mod. 200
Pcs	1	2	1	3	3	3	3	3
Ref. 1910								
Mod.	Mod. 020	Mod. 040	Mod. 050	Mod. 060	Mod. 070	Mod. 090	Mod. 100	Mod. 110
Pcs	3	3	3	3	3	3	3	3

Ref. 4995 - N° Art. 22391: 352,59 €

Display 21 - Refs. 1940 - 1910 - 1930 - 1945 - 1915

SIERRAS CALAR INSERCIÓN "T" + "U"

"T" + "U" Insertion Jig Saw Blades - Lames scies insertion "T" + "U"



Ref. 1940								
Mod.	Mod. 010	Mod. 030	Mod. 040	Mod. 060	Mod. 070	Mod. 080	Mod. 100	Mod. 140
Pcs	3	3	3	3	3	3	3	3
Ref. 1910						Ref. 1930		
Mod.	Mod. 020	Mod. 040	Mod. 050	Mod. 070	Mod. 100	Mod. 020	Mod. 030	Mod. 200
Pcs	2	2	2	2	2	1	1	1
Ref. 1945						Ref. 1915		
Mod.	Mod. 00030	Mod. 00040	Mod. 00060	Mod. 00060	Mod. 00070	Mod. 00070	Mod. 00070	Mod. 00110
Pcs	3	3	2	1	3	2	2	2

Ref. 4995 - N° Art. 22280: 382,56 €



06.

PUNTAS ATORNILLAR

Screwdriver Bits

Embouts vissage



PUNTAS ATORNILLAR

Screwdriver Bits

Embouts vissage

Ref. **1520**

PUNTA ATORNILLAR
Screwdriver Bit
Embout vissage

GAMA
Range
Gamme

Standard d = 6,35 mm

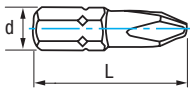

Tipo Type	D mm	L mm	DIN	Nº Art.	€ pack	Nº Art.	€ pack	Nº Art.	€ pack	Nº Art.	€ pack	Nº Art.	€ pack
HEX	2	25	C 6.3	23418	1,27	23425	2,76	23426	12,42	23429	23,60		
HEX	2,5	25	C 6.3	23430	1,27	23431	2,76	23432	12,42	23433	23,60		
HEX	3	25	C 6.3	83771	1,27	33154	2,76	23445	12,42	23446	23,60		
HEX	4	25	C 6.3	83772	1,27	33155	2,76	23447	12,42	23448	23,60		
HEX	5	25	C 6.3	83773	1,27	33156	2,76	23449	12,42	23450	23,60		
HEX	6	25	C 6.3	23451	1,27	23453	2,76	23454	12,42	23455	23,60		
HEX	7	35	C 6.3	23456	1,32	23457	2,88	23458	12,98	23459	24,66		
HEX	8	35	C 6.3	23460	1,32	23461	2,88	23462	12,98	23463	24,66		
PH	0	25	C 6.3	23464	1,27	23465	2,76	23466	12,42	23468	23,60		
PH	1	25	C 6.3	83774	1,27	33138	2,76	23469	12,42	23470	23,60		
PH	2	25	C 6.3	83776	1,27	33139	2,76	23473	12,42	23475	23,60	23476	44,85
PH	3	25	C 6.3	83778	1,27	33140	2,76	23482	12,42	23483	23,60		
PH	4	35	C 6.3	23505	1,32	23506	2,88	23509	12,98	23511	24,66		
PH	1	50	E 6.3	83775	1,96	22647	4,16	23471	18,72	23472	35,56		
PH	2	50	E 6.3	83777	1,96	22654	4,16	23477	18,72	23478	35,56	23479	67,56
PH	3	50	E 6.3	83779	1,96	22659	4,16	23503	18,72	23504	35,56		
PZ	0	25	C 6.3	23513	1,27	23515	2,76	23561	12,42	23562	23,60		
PZ	1	25	C 6.3	83780	1,27	33141	2,76	23570	12,42	23571	23,60		
PZ	2	25	C 6.3	83782	1,27	33142	2,76	23585	12,42	23588	23,60	23589	44,85
PZ	3	25	C 6.3	83784	1,27	33143	2,76	23594	12,42	23596	23,60		
PZ	4	35	C 6.3	23600	1,32	23601	2,88	23602	12,98	23606	24,66		
PZ	1	50	E 6.3	83781	1,96	23578	4,16	23579	18,72	23580	35,56		
PZ	2	50	E 6.3	83783	1,96	22663	4,16	23590	18,72	23592	35,56	23593	67,56
PZ	3	50	E 6.3	83785	1,96	22664	4,16	23597	18,72	23599	35,56		
SL	3,0×0,5	25	C 6.3	23609	1,27	23615	2,76	23616	12,42	23618	23,60		
SL	4,0×0,5	25	C 6.3	23619	1,27	23620	2,76	23622	12,42	23624	23,60		
SL	4,5×0,6	25	C 6.3	83786	1,27	33151	2,76	23669	12,42	23672	23,60		
SL	5,5×0,8	25	C 6.3	83787	1,27	33152	2,76	23693	12,42	23702	23,60		
SL	5,5×1,0	25	C 6.3	23735	1,27	23738	2,76	23741	12,42	23750	23,60		
SL	6,0×1,0	25	C 6.3	23751	1,27	23752	2,76	23754	12,42	23755	23,60		
SL	6,5×1,2	25	C 6.3	83788	1,27	33153	2,76	23757	12,42	23758	23,60		
SL	8,0×1,2	30	C 6.3	23770	1,32	23772	2,88	23773	12,98	23774	24,66		
SL	4,0×0,5	50	E 6.3	23627	1,96	23638	4,17	23660	18,78	23663	35,67		
SL	4,5×0,6	50	E 6.3	23678	1,96	22666	4,17	23681	18,78	23683	35,67		
SL	5,5×0,8	50	E 6.3	23705	1,96	22668	4,17	23714	18,78	23723	35,67		
SL	6,5×1,2	50	E 6.3	23760	1,96	22669	4,17	23766	18,78	23769	35,67		



Ref. **1520**

PUNTA ATORNILLAR

Screwdriver Bit
Embout vissage

GAMA
Range
Gamme



2 Uds **5 Uds** **25 Uds** **50 Uds** **100 Uds**

Tipo Type	D mm	L mm	DIN	Nº Art.	€ pack	Nº Art.	€ pack	Nº Art.	€ pack	Nº Art.	€ pack	Nº Art.	€ pack
TX	5	25	C 6.3	23805	1,32	23806	2,88	23807	12,98	23816	24,66		
TX	6	25	C 6.3	23817	1,32	23818	2,88	23819	12,98	23820	24,66		
TX	7	25	C 6.3	23821	1,32	23822	2,88	23832	12,98	23833	24,66		
TX	8	25	C 6.3	23835	1,32	66723	2,88	23837	12,98	23838	24,66		
TX	9	25	C 6.3	23848	1,32	23851	2,88	23853	12,98	23854	24,66		
TX	10	25	C 6.3	83789	1,32	33144	2,88	23855	12,98	23856	24,66		
TX	15	25	C 6.3	83791	1,32	33145	2,88	23859	12,98	23860	24,66	23861	46,85
TX	20	25	C 6.3	83793	1,32	33146	2,88	23866	12,98	23869	24,66	23872	46,85
TX	25	25	C 6.3	83795	1,32	33147	2,88	23877	12,98	23878	24,66	23879	46,85
TX	27	25	C 6.3	23907	1,32	33148	2,88	23908	12,98	23910	24,66		
TX	30	25	C 6.3	83797	1,32	33149	2,88	23915	12,98	23919	24,66	23920	46,85
TX	40	25	C 6.3	83799	1,32	33150	2,88	23924	12,98	23925	24,66		
TX	10	50	E 6.3	83790	2,06	22671	4,38	23857	19,70	23858	37,43		
TX	15	50	E 6.3	83792	2,06	22674	4,38	23863	19,70	23864	37,43		
TX	20	50	E 6.3	83794	2,06	22675	4,38	23873	19,70	23874	37,43	23875	71,11
TX	25	50	E 6.3	83796	2,06	22676	4,38	23894	19,70	23905	37,43	23906	71,11
TX	27	50	E 6.3	23911	2,06	22677	4,38	23912	19,70	23913	37,43		
TX	30	50	E 6.3	83798	2,06	22678	4,38	23921	19,70	23922	37,43	23923	71,11
TX	40	50	E 6.3	83800	2,06	22683	4,38	23926	19,70	23927	37,43		

TORX



TORX SEGURIDAD
Security Torx Sécurité



TS	10	25	C 6.3	31098	1,38	23949	2,94	23950	13,19	23951	25,08		
TS	15	25	C 6.3	31099	1,38	23952	2,94	23954	13,19	23956	25,08		
TS	20	25	C 6.3	31100	1,38	23959	2,94	23960	13,19	23961	25,08		
TS	25	25	C 6.3	31101	1,38	23962	2,94	23963	13,19	23964	25,08		
TS	27	25	C 6.3	31102	1,38	23965	2,94	23966	13,19	23967	25,08		
TS	30	25	C 6.3	31103	1,38	23970	2,94	23972	13,19	23973	25,08		
TS	40	25	C 6.3	31104	1,38	23974	2,94	23975	13,19	23998	25,08		

SQUARE ROBERTSON



SQ	1	25	C 6.3	23775	3,61	23776	7,66	23778	34,47	23779	65,50		
SQ	2	25	C 6.3	23786	3,61	23787	7,66	23788	34,47	23789	65,50		
SQ	3	25	C 6.3	23795	3,61	23796	7,66	23797	34,47	23798	65,50		
SQ	1	50	E 6.3	23781	5,54	23782	11,78	23784	53,03	23785	100,76		
SQ	2	50	E 6.3	23790	5,54	23791	11,78	23792	53,03	23794	100,76		
SQ	3	50	E 6.3	23799	5,54	23801	11,78	23802	53,03	23804	100,76		

TRIWING



TRW	1	25	C 6.3	23928	14,32	23929	30,43	23930	136,91				
TRW	2	25	C 6.3	23931	14,32	23932	30,43	23933	136,91				
TRW	3	25	C 6.3	23934	14,32	23935	30,43	23936	136,91				
TRW	4	25	C 6.3	23937	14,32	23938	30,43	23939	136,91				
TRW	5	25	C 6.3	23940	14,32	23941	30,43	23942	136,91				
TRW	6	25	C 6.3	23943	14,32	23944	30,43	23945	136,91				
TRW	8	25	C 6.3	23946	14,32	23947	30,43	23948	136,91				

XZN



XZN	4	25	C 6.3	24016	9,79	24027	20,80	24029	93,57				
XZN	5	25	C 6.3	24031	9,79	24032	20,80	24033	93,57				
XZN	6	25	C 6.3	24034	9,79	24041	20,80	24043	93,57				
XZN	8	25	C 6.3	24045	9,79	24046	20,80	24047	93,57				
XZN	10	25	C 6.3	24056	9,79	24117	20,80	24120	93,57				



Display 63 - Ref. 1520



∅	HEX 3	HEX 4	HEX 5	PH 1	PH 2	PH 3
Pcs	5	5	5	5	5	5
∅	PZ 1	PZ 2	PZ 3	SL 4,5	SL 5,5	SL 6,5
Pcs	5	5	5	5	5	5
∅	T 10	T 15	T 20	T 25	T 30	T 40
Pcs	5	5	5	5	5	5
∅	PH 1	PH 2	PH 3	PZ 1	PZ 2	PZ 3
Pcs	3	3	3	3	3	3
∅	SL 4,5	SL 5,5	SL 6,5	T 25	T 30	T 40
Pcs	3	3	3	3	3	3

Ref. 4995 - N° Art. 37502: 359,19 €

Display 71 - Ref. 1520

New!



L	PZ 1	PZ 1	PH 1	PH 1	TX 10	TX 10	TX 15	TX 15	HEX 3	SL 4,5x0,6	
Pcs	5	5	5	5	5	5	5	5	5	5	
L	PZ 2	PZ 2	PH 2	PH 2	TX 20	TX 20	TX 25	TX 25	HEX 4	SL 5,5x0,8	
Pcs	5	5	5	5	5	5	5	5	5	5	
L	PZ 3	PZ 3	PH 3	PH 3	TX 30	TX 30	TX 40	TX 40	HEX 5	SL 6,5x1,2	
Pcs	5	5	5	5	5	5	5	5	5	5	
Pcs	SET			SET			SET		Quick-lock INOX	Magnético IND	Magnético IND
	3			3			3		3	3	3

Ref. 4995 - N° Art. 83801: 389,79 €

Box-Pallet - Ref. 1520

New!



Set 13 Pcs

Cont.	N° Art.	€
PH: 1 - 2 - 3 +	83769	11,87
PZ: 1 - 2 - 3 +		
T: 10 - 15 - 20 - 25 - 30 - 40		

12 Sets

N° Art.	€
83770	135,32



Sets - Ref. 1520



Tipo
Type **PH-PZ-SL**

Set 12 Pcs

D mm	L mm	DIN	Nº Art.	€
PH: 1 - 2 (2 pcs.) - 3 +	25	C 6.3	33754	10,78
PZ: 1 - 2 (2 pcs.) - 3 +				
SL: 4,5x0,6 - 5,5x0,8 - 6,5-1,2				

Hasta fin de existencias - While stock lasts - Jusqu'à la fin de stock

Box-Pallet - Ref. 1520



6 Sets

Nº Art.	€
68168	94,85

Set 31 Pcs

Nº Art.	€
67769	16,64

31
pcs

PH	d mm: 6,35
2x PH1	25 mm
3x PH2	
1x PH3	

PZ	d mm: 6,35
2x PZ1	25 mm
8x PZ2	
2x PZ3	

Tx	d mm: 6,35
1x T10	25 mm
2x T15	
2x T20	
3x T25	
3x T30	
1x T40	

Adapt. Quick-Lock INOX/Stainless
L mm: 60 - d mm: 6,35



Ref. **1521**

PUNTA ATORNILLAR PRO

PRO Screwdriver Bit
Embout vissage PRO



Torsion
d = 6,35 mm

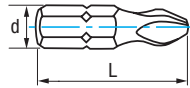

PHILLIPS



Tipo Type	D mm	L mm	DIN		Nº Art.	€ pack
PH	1	25	C 6.3	5	33173	3,52
PH	1	50	E 6.3	3	33192	6,49
PH	2	25	C 6.3	5	33174	3,52
PH	2	50	E 6.3	3	33193	6,49
PH	3	25	C 6.3	5	33175	3,52
PH	3	50	E 6.3	3	33194	6,49

POZIDRIVE



Tipo Type	D mm	L mm	DIN		Nº Art.	€ pack
PZ	1	25	C 6.3	5	33176	3,52
PZ	1	50	E 6.3	3	33195	6,49
PZ	2	25	C 6.3	5	33177	3,52
PZ	2	50	E 6.3	3	33196	6,49
PZ	3	25	C 6.3	5	33178	3,52
PZ	3	50	E 6.3	3	33197	6,49

PLANA / Flat / Plate



Tipo Type	D mm	L mm	DIN		Nº Art.	€ pack
SL	4,5×0,6	25	C 6.3	5	33186	6,04
SL	4,5×0,6	50	E 6.3	3	33204	8,40
SL	5,5×0,8	25	C 6.3	5	33187	6,04
SL	5,5×0,8	50	E 6.3	3	33205	8,40
SL	6,5×1,2	25	C 6.3	5	33188	6,04
SL	6,5×1,2	50	E 6.3	3	33206	8,40

TORX



Tipo Type	D mm	L mm	DIN		Nº Art.	€ pack
Tx	8	25	C 6.3	5	66725	5,69
Tx	10	25	C 6.3	5	33179	5,69
Tx	10	50	E 6.3	3	33198	8,05
Tx	15	25	C 6.3	5	33180	5,69
Tx	15	50	E 6.3	3	33199	8,05
Tx	20	25	C 6.3	5	33181	5,69
Tx	20	50	E 6.3	3	33200	8,05
Tx	25	25	C 6.3	5	33182	5,69
Tx	25	50	E 6.3	3	33201	8,05
Tx	27	25	C 6.3	5	33183	5,69
Tx	27	50	E 6.3	3	34144	8,05
Tx	30	25	C 6.3	5	33184	5,69
Tx	30	50	E 6.3	3	33202	8,05
Tx	40	25	C 6.3	5	33185	5,69
Tx	40	50	E 6.3	3	33203	8,05



Ref. **1523**

PUNTA ATORNILLAR IMPACTO MANGO E6.3

Impact Screwdriver Bit E6.3 Shank
Embout visage Impact queue E6.3



New!

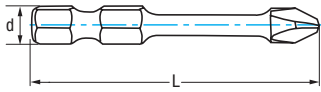

S2 material	60 HRC	d = 6,35 mm
-------------	--------	-------------

- Larga vida útil
- Soporta grandes pares de torsión
- Óptimo acople entre la punta y la cabeza del tornillo
- Long life
- Suitable for high-torque
- Optimal fit between the tip and the screw head
- Longue durée de vie
- Supporte de grands couples de torsion
- Adaptation optimale entre la pointe et la tête de la vis

PHILLIPS



Tipo	L mm	DIN	Torque (Nm)		Nº Art.	€ pack
PH 1	50	E 6.3	5,00	2	58907	2,97
PH 2	50	E 6.3	14,00	2	22807	2,97
PH 3	50	E 6.3	33,60	2	22816	2,97

POZIDRIVE



PZ 1	50	E 6.3	5,00	2	58910	2,97
PZ 2	50	E 6.3	14,00	2	22818	2,97
PZ 3	50	E 6.3	29,40	2	22820	2,97

TORX



TX 20	50	E 6.3	12,70	2	22836	3,68
TX 25	50	E 6.3	19,00	2	22839	3,68
TX 30	50	E 6.3	37,40	2	22843	3,68
TX 40	50	E 6.3	65,10	2	22845	3,68



Ref. **1524**

PUNTA ATORNILLAR EXTRA LARGA

Extra Long Screwdriver Bit
Embout vissage extra-long

New!

Standard

d =
6,35 mm

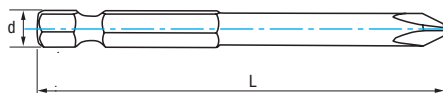

1
Uds



5
Uds

Tipo Type	D mm	L mm	DIN	Nº Art.	€ pack	Nº Art.	€ pack
--------------	---------	---------	-----	------------	-----------	------------	-----------

PHILLIPS



PH	1	75	E 6.3	23222	1,50	23225	6,39
PH	2	75	E 6.3	23270	1,47	23271	6,39
PH	3	75	E 6.3	23278	1,50	23279	6,39
PH	1	100	E 6.3	23227	1,72	23229	7,31
PH	2	100	E 6.3	23274	1,72	23275	7,31
PH	3	100	E 6.3	23280	1,72	23281	7,31
PH	1	150	E 6.3	23230	2,42	23231	10,30
PH	2	150	E 6.3	23276	2,42	23277	10,30
PH	3	150	E 6.3	23282	2,42	23283	10,30

POZIDRIVE



PZ	1	75	E 6.3	23284	1,50	23285	6,39
PZ	2	75	E 6.3	23290	1,50	23291	6,39
PZ	3	75	E 6.3	23296	1,50	23297	6,39
PZ	1	100	E 6.3	23286	1,72	23287	7,31
PZ	2	100	E 6.3	23292	1,72	23293	7,31
PZ	3	100	E 6.3	23298	1,72	23299	7,31
PZ	1	150	E 6.3	23288	2,42	23289	10,30
PZ	2	150	E 6.3	23294	2,42	23295	10,30
PZ	3	150	E 6.3	23300	2,42	23301	10,30

TORX



Tx	10	75	E 6.3	23330	1,59	23333	6,75
Tx	15	75	E 6.3	23342	1,59	23351	6,75
Tx	20	75	E 6.3	23359	1,59	23360	6,75
Tx	25	75	E 6.3	23366	1,59	23367	6,75
Tx	27	75	E 6.3	23384	1,59	23387	6,75
Tx	30	75	E 6.3	23395	1,59	23398	6,75
Tx	40	75	E 6.3	23408	1,59	23409	6,75
Tx	10	100	E 6.3	23334	1,81	23338	7,73
Tx	15	100	E 6.3	23352	1,81	23353	7,73
Tx	20	100	E 6.3	23361	1,81	23362	7,73
Tx	25	100	E 6.3	23374	1,81	23376	7,73
Tx	27	100	E 6.3	23388	1,81	23390	7,73
Tx	30	100	E 6.3	23399	1,81	23400	7,73
Tx	40	100	E 6.3	23410	1,81	23411	7,73
Tx	10	150	E 6.3	23339	2,53	23340	10,76
Tx	15	150	E 6.3	23355	2,53	23357	10,76
Tx	20	150	E 6.3	23364	2,53	23365	10,76
Tx	25	150	E 6.3	23382	2,53	23383	10,76
Tx	27	150	E 6.3	23392	2,53	23393	10,76
Tx	30	150	E 6.3	23404	2,53	23405	10,76
Tx	40	150	E 6.3	23414	2,53	23417	10,76



New!

SET PUNTAS DE PRECISI3N Precision Screw Bit Set Set embouts vissage de pr3cision



6 Sets
N° Art. €
21335 152,87

Set 58 Pcs

N° Art. €
21334 26,82

58
pcs



48 Puntas / Bits / Embouts material S2

PH	1.0 - 1.5 - 2.0 - 2.5 - 3.0 - 3.5
HEX	0.9 - 1.3 - 1.5 - 2.0 - 2.5 - 3.0 - 3.5 - 4.0 - 4.5 - 5.0 - 6.0
TS	2 - 3 - 4 - 5 - 6 - 7 - 8 - 9 - 10 - 15 - 20
SL	1.0 - 1.5 - 2.0 - 2.5 - 3.0 - 3.5
P	0.8 - 1.2 - 1.5 - 2.0
Y	0.8 - 2.0 - 2.5 - 3.0
	1.5
	SQ 0 - 1 - 2
	TA 2.0 - 2.3

6 Vasos / Sockets / Douilles hex. material CrV

M2.5 - M3.0 - M3.5 - M4.0 - M4.5 - M5.0

2 Adaptadores / Adaptors / Adaptateurs

H4.0 → H6.3 H6.3 → H4.0

- Destornillador Profesional Aleaci3n de Aluminio**
1 Profesional Aluminum Alloy Screwdriver
Tournevis en alliage aluminium
- Alargador Flexible**
1 Flexible Extension Bar
Rallonge Souple

PUNTAS DE GRADO INDUSTRIAL	INDUSTRIAL GRADE SCREW BITS	EMBOUTS À DEGRÉ INDUSTRIEL
- Acero S2 de gran dureza (60 HRC)	- Shock-resisting S2 Steel (60 HRC)	- Acier S2 de grande dureté (60 HRC)
- Cuellos largos para un mejor acceso	- Long neck. Suitable for hard-to-reach areas	- Coud longs pour un meilleur accès
- Magn3ticos	- Magnetic	- Magn3tiques

Ref. **1527**

TOPE PROFUNDIDAD PLADUR

Plasterboard Depth Stop
But3e profondeur Placoplâtre



Tipo Type	D mm	L mm	DIN	3	N° Art.	€ pack
PH	2	25	C 6.3	2	77339	3,59
PH	2	50	E 6.3	2	74858	4,48
PZ	2	25	C 6.3	2	81588	3,59
PZ	2	50	E 6.3	2	81589	4,48



Set 4 Pcs

Cont.	N° Art.	€
PH2 - L25 PH2 - L50 PZ2 - L25 PZ2 - L50	81594	8,09



Ref. **1529**

ADAPTADORES PUNTAS ATORNILLAR

Screwdriver Bit Adaptors
Adaptateurs embouts vissage



Tipo Type	L mm	d mm		Nº Art.	€ pack
Quick Lock INOX / Stainless	60	6,35	1	82687	8,48



Tipo Type	L mm	d mm		Nº Art.	€ pack
Quick Lock	60	6,35	1	33746	7,07



Tipo Type	L mm	d mm		Nº Art.	€ pack
SDS plus	78	6,35	1	33745	19,06



Tipo Type	L mm	d mm		Nº Art.	€ pack
Magnético IND	60	6,35	1	33747	3,52

Adaptador Magnético para Tornillos
Magnetic Screw Adaptor
Adaptateur magnetique pour vis



Tipo Type	mm	L mm	d mm		Nº Art.	€
Adapt.	6	65	6,35	1	42466	3,66
Adapt.	7	65	6,35	1	42472	3,66
Adapt.	8	65	6,35	1	42475	3,66
Adapt.	10	65	6,35	1	42478	3,89
Adapt.	12	65	6,35	1	42481	3,89
Adapt.	13	65	6,35	1	42483	3,89

* Interno / Internal / Intérieur

New!

Adaptador de 1/4 a 1/2
1/4 to 1/2 Adaptor
Adaptateur de 1/4 à 1/2

Para uso de herramientas de mango E6.3(1/4)
en llaves de impacto 1/2

It allows the use of E6.3(1/4) shank tools on a 1/2 Impact wrench

Pour utiliser des outils à queue hexagonale E6.3(1/4)
avec clés à choc de 1/2



mm	L mm	d mm		Nº Art.	€ pack
12,7	50	6,35	1	75107	7,36



Set **1529**

Adaptador Magnético para Tornillos
Magnetic Screw Adaptor
Adaptateur magnetique pour vis

5 Pcs

D mm	L mm	d mm		Nº Art.	€
6-7-8-10-13	65	6,35	5	69751	18,76



Ref. **3407**

EXTRACTORES IMPACTO

Impact Extractor
Extracteurs impact

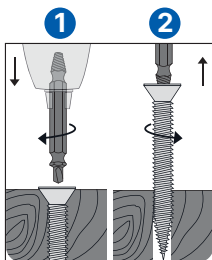

1. Taladrar el tornillo
2. Dar la vuelta y extraer

1. Drill the screw
2. Turn over and remove

1. Percer la vis
2. Retourner et retirez

Mod.	Cap. (mm)	Nº Art.	€
Nº 1	3-5	14953	6,32
Nº 2	4-8	14955	6,32
Nº 3	5-10	14956	6,32
* Nº 4	6-12	14958	6,32

- * Nº4 no es válido para atornillador de impacto
- * Nº4 is not suitable for impact drivers
- * Nº4 n'est pas valide pour les visseuses impact



Set 17 Pcs

Nº Art.	€
72898	25,29



17
pcs

Extractores Impacto
Impact Extractors
Extracteurs impact
N.º 1 - 2 - 3 - 4

PH d mm: 6,35
PH1
PH2
PH3
±25 mm

PZ d mm: 6,35
PZ1
PZ2
PZ3
±25 mm

d mm: 6,35
Tx
T10
T15
T20
T25
T30
T40
±25 mm

Adapt. Quick-Lock
L mm: 60 - d mm: 6,35

Box-Pallet - Ref. 3407



6 Sets

Nº Art.	€
74792	144,53



Ref. **1461**

SET BROCAS Y PUNTAS ATORNILLAR







Drill Bit & Screwdriver Bit Set
Jeu de forets et embouts vissage



72
pcs

Brocas Metal Metal Drill Bits Forets Métal 2 - 3 - 4 - 5 - 6 - 8 mm	Brocas Pared Masonry Drill Bits Forets Maçonnerie 4 - 5 - 6 - 8 mm	Brocas Madera Wood Drill Bits Forets Bois 3 - 4 - 5 - 6 - 8 mm
Adapt. Magnético Magnetic Adapt. Adapt. Magnétique ● 6 - 7 - 8 10 - 13 mm	Adapt. Quick-Lock INOX/Stainless  L mm: 60 - d mm: 6,35 1 pc.	Cuter Hoja Partible Snap-Off Box Cutter Cou-teaux à lames rétractables 1 pc.

Puntas Atornillar / Screwdriver Bits / Embouts Vissage

 PH d mm: 6,35 3x PH1 4x PH2 3x PH3 ←25 mm→	 Tx d mm: 6,35 T5 - T6 2x T10 T15 3x T20 4x T25 T27 3x T30 2x T40 ←25 mm→	 SL d mm: 6,35 SL 4 SL 4,5 SL 5,5 SL 6 SL 6,5 ←25 mm→
 PZ d mm: 6,35 3x PZ1 4x PZ2 2x PZ3 ←25 mm→	 SQ d mm: 6,35 SQ 1 SQ 2 SQ 3 ←25 mm→	 HEX d mm: 6,35 H2 H3 H4 H5 H6 ←25 mm→

N°	€
Art.	
78504	57,14



PRESENTACIONES

Presentations

Presentations

PRESENTACIÓN IZAR EN LÍNEA

IZAR Line Presentation
Presentation IZAR ligne

430

PRESENTACIÓN IZAR EN CASCADA

IZAR Cascade Presentation
Presentation IZAR cascade

436

EXPOSITORES APILABLES

Stacking Exhibitors
Présentoirs apilables

440



¡NUEVA IMPLANTACIÓN LÍNEA!

New Line Stock Offer!

Nouveau implantation ligne!

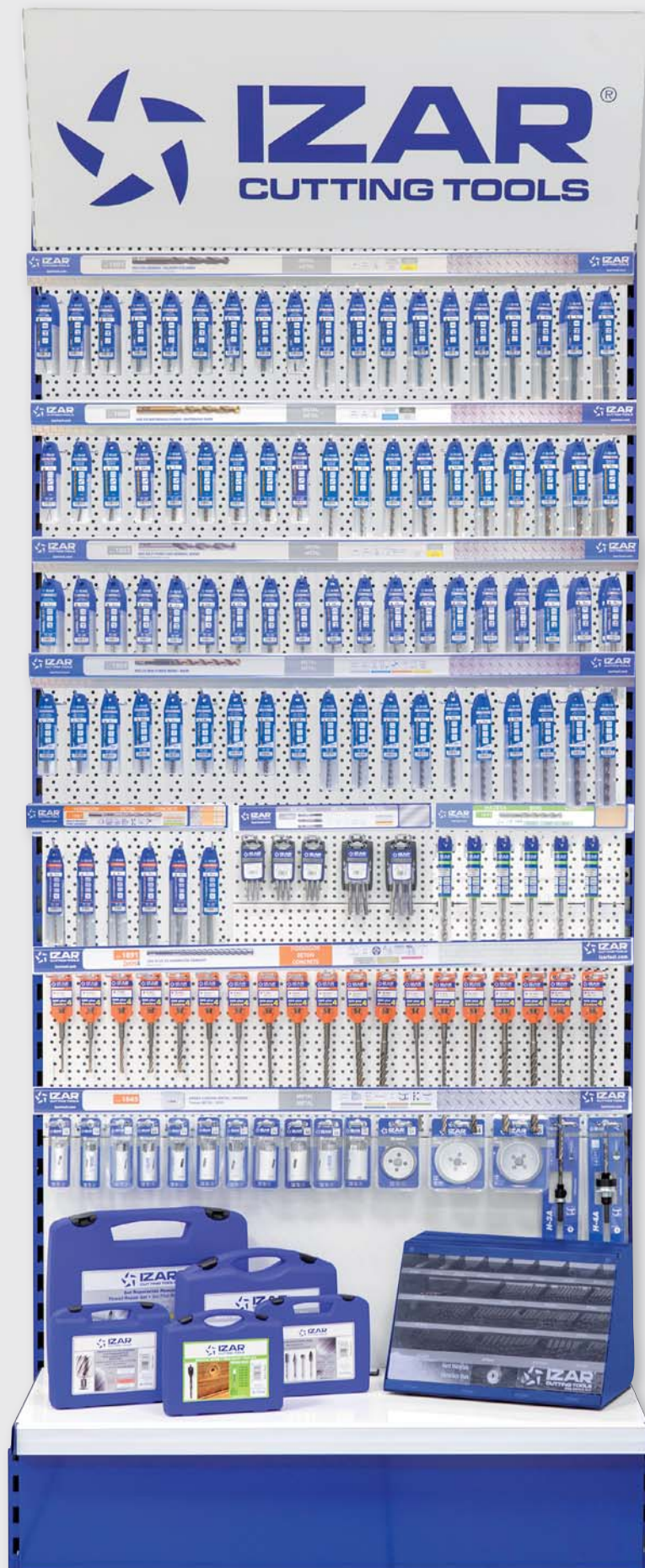

¡NUEVA IMPLANTACIÓN LÍNEA!

New Line Stock Offer!

Nouveau implantation ligne!

1 m
1001

BROCA MANGO CILÍNDRICO HSS

HSS Straight Shank Drill Bit
Foret queue cylindrique HSS

Ref. 4995 - N° Art. 70942: 394,80 €

>> Pag. 59

1 m
1006

BROCA MANGO CILÍNDRICO COBALTO

Cobalt Straight Shank Drill Bit
Foret queue cylindrique Cobalt

Ref. 4995 - N° Art. 70936: 621,95 €

>> Pag. 32

1 m
1002

BROCA MANGO CILÍNDRICO HSS SPEED POINT

Speed Point HSS Straight Shank Drill Bit
Foret queue cylindrique HSS Speed Point

Ref. 4995 - N° Art. 70947: 434,50 €

>> Pag. 70

1 m
1004

BROCA UNIVERSAL COBALTO MULTI INOX

Multi-STAINLESS Cobalt Universal Drill Bit
Foret universel Cobalt Multi INOX

Ref. 4995 - N° Art. 70933: 617,61 €

>> Pag. 25

33cm
1821

BROCA PUNTA METAL DURO PARED PRO 4Z+ MANGO 3 PLANOS

3-Flat Shank 4Z+ Professional Concrete Carbide Tipped Drill Bit
Foret pointe carbure béton professionnel 4Z+ queue 3 plans

Ref. 4995 - N° Art. 84075: 159,75 €

>> Pag. 267

33cm
3003

JUEGO MACHOS MANO MÉTRICA

Metric Hand Tap Set
Jeu de tarauds à main métrique

Ref. 4995 - N° Art. 70990: 350,85 €

>> Pag. 134

33cm
1641

BROCA PUNTA CENTRAR PRO

PRO Drill Bit
Foret auto-centreur PRO

Ref. 4995 - N° Art. 71044: 119,30 €

>> Pag. 298

1 m
1891

BROCA-MARTILLO SDS PLUS 4Z

4Z Cutter SDS plus Rotary Hammer Drill Bit
Foret percussion SDS plus 4Z

Ref. 4995 - N° Art. 71015: 348,46 €

>> Pag. 239

1 m
1645

SIERRA CORONA METAL / MADERA

METAL / WOOD Hole Saw
Trépan MÉTAL / BOIS

Ref. 4995 - N° Art. 71040: 449,88 €

>> Pag. 278

TOTAL: 3.497,10 €

* Maletines y Cabinet no incluidos
Cases & Cabinet not included
Mallettes et Présentoir non inclus



ACCESORIOS LÍNEAS

Line Accessories
Accessoires ligne



Panel Inicial 1 m
Initial Panel
Panneau initial

N° Art.	€
71120	689,37



Panel Adicional 1 m
Additional Panel
Panneau supplémentaire

N° Art.	€
71169	587,91



ACCESORIOS LÍNEAS

Line Accessories
Accessoires ligne

Copete Liso 1 m
Straight Top
Panneau supérieur lisse



N° Art.	€
59996	97,67

Copete Curvo 1 m
Curve Top
Panneau supérieur courbe



Mod.	N° Art.	€
Standard	71112	164,09
Standard + Led	71113	164,09



Cajonera zócalo 100×40
Drawer
Tiroir

N° Art.	€
71111	191,44



Balda
Shelf
Étagère

Mod.	N° Art.	€
100×30 cm	64056	50,41
100×40 cm	64057	50,41



Balda-Cesta 30×30
Basket-Shelf
Étagère-Panier

N° Art.	€
71124	27,34



Balda-Podium 30×30
Podium-Shelf
Étagère-Podium

N° Art.	€
71110	27,34

ACCESORIOS LÍNEAS

Line Accessories
Accessoires ligne

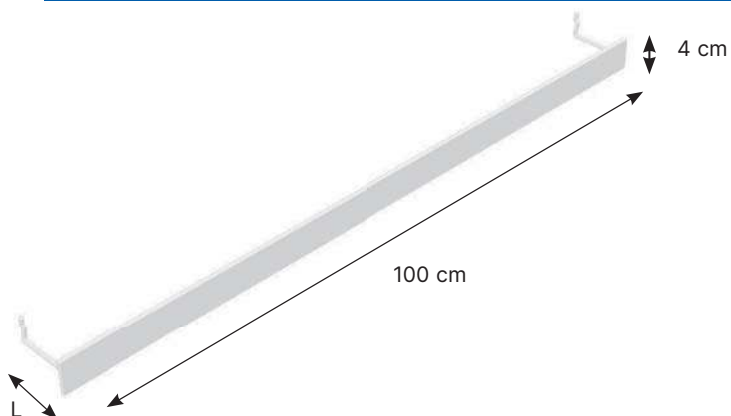

Porta-Cartel 1 m
Poster-Holder
Porte-Affiche

L cm	N° Art.	€
7,5	69760	33,82
15	12696	33,82
30	24448	33,82

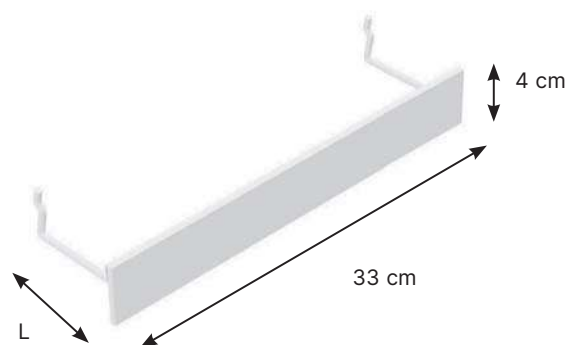

Porta-Cartel 33cm
Poster-Holder
Porte-Affiche

L cm	N° Art.	€
7,5	69781	18,39
15	12686	18,39
30	24449	18,39

Gancho simple
Simple Hook
Crochet simple



Mod.	N° Art.	€
4×100 mm	52956	0,58
4×150 mm	57810	0,77
5×200 mm	22981	0,80
6×300 mm	78834	0,83

New!



Mod.	N° Art.	€
5×250 mm	75633	1,37

Gancho doble
Double Hook
Crochet double



Mod.	N° Art.	€
4×150 mm	52957	1,15

New!



Mod.	N° Art.	€
5×250 mm	78512	1,51

Porta-precios
Price Holder
Porte prix



N° Art.	€
24261	0,23



ACCESORIOS LÍNEAS

Line Accessories
Accessoires ligne



1 Rail
Rail / Raille

N° Art.	€
72270	2,46

3 Tope frontal / Front block
Support adhesif frontal

N° Art.	€
71107	6,88

5 Divisor balda
Shelf divider / Diviseur étagère

N° Art.	€
71106	1,83

2 Empujador
Pusher / Pousser

N° Art.	€
71109	1,94

4 Tope trasero / Back block
Support adhérière

N° Art.	€
71108	3,99

6 Cartón Fin Gancho
Hook End Carton / Carton fin crochet



	N° Art.	€
Plastic Pouch	71118	0,25
Doble Blister	71119	0,25



IMPLANTACIÓN DISPLAY 2 METROS

2 Metre Display Stock Offer

Offre implantation presentoir 2 metres



IMPLANTACIÓN DISPLAY 2 METROS

2 Metre Display Stock Offer

Offre implantation presentoir 2 metres

Display 01	BROCA-MARTILLO SDS PLUS 1 SDS plus Rotary Hammer Drill Bit 1 Foret percussion SDS plus 1	Ref. 4995 - N° Art. 22182: 558,61 € >> Pag. 243
Display 02	BROCA-MARTILLO SDS PLUS 2 SDS plus Rotary Hammer Drill Bit 2 Foret percussion SDS plus 2	Ref. 4995 - N° Art. 22183: 659,74 € >> Pag. 243
Display 03	BROCA-MARTILLO SDS MAX 4 PUNTAS 4-Cutter SDS max Rotary Hammer Drill Bit Foret percussion SDS max 4 pointes	Ref. 4995 - N° Art. 22315: 1.382,84 € >> Pag. 249
Display 04	CINCELES SDS MAX / PLUS SDS max / plus Chisels Burins SDS max / plus	Ref. 4995 - N° Art. 22289: 474,00 € >> Pag. 257
Display 05	CORONA LIGERA PARED PROFESIONAL Professional Concrete Light Hollow Core Bit Trépan béton professionnel	Ref. 4995 - N° Art. 22418: 698,39 € >> Pag. 247
Display 06	CORONA PERFORADORA TALADRO PERCUTOR HORMIGÓN Tapered Hollow Hammer Core Bit Trépan pour perceuses percussion lourds béton	Ref. 4995 - N° Art. 22463: 932,43 € >> Pag. 251
Display 07	BROCA PUNTA METAL DURO PARED PROFESIONAL Professional Concrete Carbide Tipped Drill Bit Foret pointe carbure béton professionnel	Ref. 4995 - N° Art. 22191: 622,07 € >> Pag. 270
Display 10	BROCAS MADERA PALA Y 3 PUNTAS Wood Drill Bits Flat & 3-Pointed Forets bois mèches plates & 3-pointes	Ref. 4995 - N° Art. 22184: 342,13 € >> Pag. 301
Display 12	PORTA-BROCAS TALADROS PORTÁTILES Y ESTACIONARIOS Portable & Stationary Drilling Machine Drill-Chucks Mandrins perceuses portables & fixes	Ref. 4995 - N° Art. 22334: 884,00 € >> Pag. 96
Display 13	BROCA MANGO CILÍNDRICO COBALTO Cobalt Straight Shank Drill Bit Foret queue cylindrique Cobalt	Ref. 4995 - N° Art. 22181: 619,62 € >> Pag. 33
Display 14	BROCA MANGO CILÍNDRICO HSS HSS Straight Shank Drill Bit Foret queue cylindrique HSS	Ref. 4995 - N° Art. 22162: 437,83 € >> Pag. 59
Display 18	BROCA MANGO REBAJADO HSS HSS Reduced Shank Drill Bit Foret queue réduit HSS	Ref. 4995 - N° Art. 22352: 648,13 € >> Pag. 75
Display 19	SIERRA CORONA METAL / MADERA METAL / WOOD Hole Saw Trépan MÉTAL / BOIS	Ref. 4995 - N° Art. 22220: 962,42 € >> Pag. 278
Display 20	SIERRAS CALAR INSERCIÓN "T" "T" Insertion Jig Saw Blades Lames scies insertion "T"	Ref. 4995 - N° Art. 22391: 352,59 € >> Pag. 416
Display 23	JUEGOS CASSETTE MADERA Y CONSTRUCCIÓN Wood & Construction Cassette Sets Jeux cassette Bois & Construction	Ref. 4995 - N° Art. 22372: 430,09 € >> Pag. 302
Display 24	SETS BROCAS MANGO CILINDRICO HSS + HSSE HSS + HSSE Straight Shank Drill Bit Sets Jeux forets queue cylindrique HSS + HSSE	Ref. 4995 - N° Art. 22320: 530,93 € >> Pag. 33
Display 61	BROCA-MARTILLO SDS PLUS 4Z 4Z Cutter SDS plus Rotary Hammer Drill Bit Foret percussion SDS plus 4Z	Ref. 4995 - N° Art. 29487: 456,24 € >> Pag. 240



TOTAL: 10.922,06 €



IMPLANTACIÓN DISPLAY 1 METRO

1 Metre Display Stock Offer

Offre implantation presentoir 1 metre



Display
01

BROCA-MARTILLO SDS PLUS 1
SDS plus Rotary Hammer Drill Bit 1
Foret percussion SDS plus 1

Ref. 4995 - N° Art. 22182: **558,61 €**

>> Pag. 243

Display
02

BROCA-MARTILLO SDS PLUS 2
SDS plus Rotary Hammer Drill Bit 2
Foret percussion SDS plus 2

Ref. 4995 - N° Art. 22183: **659,74 €**

>> Pag. 243

Display
07

BROCA PUNTA METAL DURO PARED PROFESIONAL
Professional Concrete Carbide Tipped Drill Bit
Foret pointe carbure béton professionnel

Ref. 4995 - N° Art. 22191: **622,07 €**

>> Pag. 270

Display
10

BROCAS MADERA PALA Y 3 PUNTAS
Wood Drill Bits Flat & 3-Pointed
Forets bois mèches plates & 3-pointes

Ref. 4995 - N° Art. 22184: **342,13 €**

>> Pag. 301

Display
13

BROCA MANGO CILÍNDRICO COBALTO
Cobalt Straight Shank Drill Bit
Foret queue cylindrique Cobalt

Ref. 4995 - N° Art. 22181: **619,62 €**

>> Pag. 33

Display
14

BROCA MANGO CILÍNDRICO HSS
HSS Straight Shank Drill Bit
Foret queue cylindrique HSS

Ref. 4995 - N° Art. 22162: **437,83 €**

>> Pag. 59

Display
19

SIERRA CORONA METAL / MADERA
METAL / WOOD Hole Saw
Trépan MÉTAL / BOIS

Ref. 4995 - N° Art. 22220: **962,42 €**

>> Pag. 278

Display
23

JUEGOS CASSETTE MADERA Y CONSTRUCCIÓN
Wood & Construction Cassette Sets
Jeux cassette Bois & Construction

Ref. 4995 - N° Art. 22372: **430,09 €**

>> Pag. 302

TOTAL: 4.632,51 €



ACCESORIOS DISPLAYS

Display Accessories
Accessoires presentoir

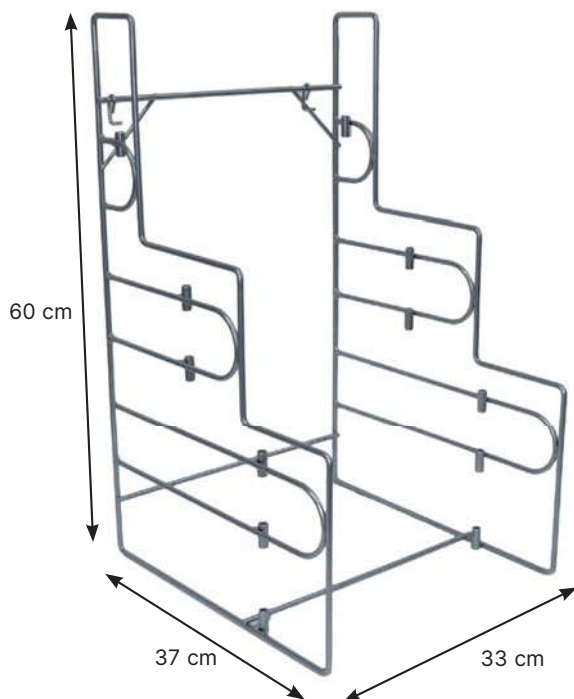

Display-Cascada
Cascade-Display
Display-Cascade

N° Art.	€
20182	48,45



Cabezal
Header
Tête

N° Art.	€
22651	13,68



Display-Línea
Line-Display
Display-Ligne

N° Art.	€
22650	30,01



Gancho-08
Hook-08
Crochet-08

N° Art.	€
51837	12,11



Gancho-10
Hook-10
Crochet-10

N° Art.	€
51840	12,90



Gancho-06-Doble
Hook-06-Double
Crochet-06-Double

N° Art.	€
22653	13,44



Gancho-08-Doble
Hook-08-Double
Crochet-08-Double

N° Art.	€
33241	15,32

SISTEMA DE EXPOSITORES APILABLES

Stacking Exhibitors System

Système présentoirs empilables



Expo 1602 **1.**

EXPOSITOR BROCAS ESCALONADAS

Step Drill Display

Présentoirs forets étagés

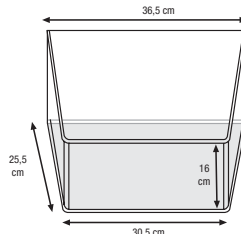

Cap. mm	N° Art.	Uds.
4-12	12048	2
4-20	12054	2
6-30	12060	2
9-36	12066	2
12-20	56798	2
20-30	56799	2
30-40	60715	1
40-50	60716	1
50-60	60717	1

15 Pcs

N° Art. 1.486,09
65184 €

Expo 9200 **2.**

EXPOSITOR FRESAS ROTATIVAS

Rotary Burr Display

Présentoirs fraises limes rotatives carbure

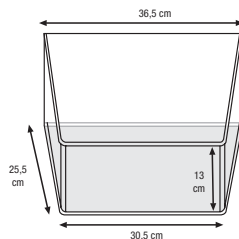

48 Pcs

N° Art. 1.555,06
57079 €

Ref.	Diam. mm	N° Art.	Uds.
9260	06,00X06,00	44141	2
	08,00X06,00	44142	2
	09,60X06,00	44143	2
	12,70X06,00	44144	2
9251	06,00X06,00	44438	2
	08,00X06,00	44439	2
	09,60X06,00	44440	2
	12,70X06,00	44441	2
9254	06,00X06,00	44488	2
	08,00X06,00	44494	2
	09,60X06,00	44500	2
	12,70X06,00	44512	2
9258	06,00X06,00	44721	2
	08,00X06,00	44722	2
	09,60X06,00	44723	2
	12,70X06,00	44724	2
9267	06,00X06,00	44792	2
	08,00X06,00	44793	2
	10,00X06,00	44794	2
	12,70X06,00	44795	2
9268	06,00X06,00	44808	2
	08,00X06,00	44809	2
	09,60X06,00	44811	2
	12,70X06,00	44814	2

Expo 1667 **3.**

EXPOSITOR CORONAS REAFILABLES HSS

HSS Resharpenable Hole Saw Exhibitor

Présentoir fraises à trépaner HSS

31 Pcs

N° Art. 1.032,73
66804 €

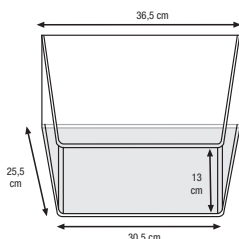

Diam.	N° Art.	Uds.	Diam.	N° Art.	Uds.	Diam.	N° Art.	Uds.	Diam.	N° Art.	Uds.
12	56569	1	20	56154	1	28	56587	1	39	56594	1
13	56570	1	21	56582	1	29	56588	1	40	56161	1
14	56572	1	22	56155	1	30	56158	1	42	56596	1
15	56573	1	23	56583	1	32	56159	1	45	56597	1
16	56152	1	24	56584	1	33	56590	1	48	56163	1
17	56576	1	25	56156	1	35	56160	1	50	56164	1
18	56578	1	26	56585	1	36	56591	1	65	56602	1
19	56579	1	27	56157	1	38	56593	1			





Matières premières de qualité supérieure

izartool.com/fr

Nuevo Portal de compras

New Shopping site

Nouveau site d'achat



Accede a todo el catálogo en un click
Encuentra fácilmente la herramienta que necesitas
Ahorra tiempo automatizando gestiones
Consulta stocks, accede y descarga facturas, pedidos, etc...

Access the entire catalogue in one click
Easily find the tool you need
Save time by automating procedures
Check stocks, access and download invoices, orders, etc...

Accédez à l'intégralité du catalogue en un click
Trouvez facilement l'outil dont vous avez besoin
Gagnez du temps en automatisant les procédures
Vérifiez le stocks, accédez et téléchargez les factures, commandes, etc...

CONDICIONES GENERALES VENTA

1. CONDICIONES DE PAGO

Giro a 30 días f.f. NETO.

2. VENCIMIENTOS FIJOS

En caso de fechas fijas de pago que rebasen los plazos estipulados giraremos a la fecha fijada pero inmediata anterior, según corresponda, siendo el plazo máximo en todo caso de 60 días, fecha factura o envío.

3. SEGURO

Las mercancías viajarán por exclusiva cuenta y riesgo del comprador, siendo siempre a cargo del mismo la prima del seguro que se realice, en los casos que el cliente desee asegurarla.

4. RECLAMACIONES

Se atenderán aquellas reclamaciones que se planteen dentro de los 8 días siguientes a la recepción del material no aceptando ninguna devolución sin el previo conocimiento de Fábrica.

5. DEVOLUCIONES

Sólo se aceptarán las devoluciones por defecto de fabricación o error atribuible a IZAR CUTTING TOOLS S.A.L. No se aceptarán devoluciones sin previa autorización de Fábrica o de nuestro delegado o representante. Las devoluciones serán a portes pagados e irán acompañadas de la factura original.

No se admitirán devoluciones procedentes de promociones ni en estuches defectuosos. Toda devolución originará una nota de cargo del 20% de su valor en concepto de manipulación e inspección de control de calidad.

6. CONDICIONALIDAD

La aceptación de las mercancías sin el rechazo inmediato por parte del comprador supone la aprobación de estas condiciones generales de venta y su modificación solamente tendrá validez si consta por escrito la conformidad de IZAR CUTTING TOOLS S.A.L.

7. I.V.A.

Los precios están sujetos al Impuesto sobre el Valor Añadido, siendo a cargo del cliente el recargo correspondiente.

8. GARANTÍAS

Todas las herramientas están garantizadas contra cualquier defecto de fabricación y materiales, sin responsabilizarse Fábrica de su utilización inadecuada. En todo caso, nuestra responsabilidad estará limitada al valor de la herramienta suministrada. Nos reservamos el derecho de modificar, sin previo aviso, las dimensiones, calidades del acero y, en general, todas las características técnicas de las herramientas. No será sustituida

ninguna herramienta sin el informe previo de nuestro Dpto. de Control de Calidad.

9. PORTES

Se suministrarán con franquicia de portes todos aquellos envíos cuyo valor neto de factura supere los 180 € netos por cada envío en territorio peninsular e Islas Baleares; 300 € en Canarias, Ceuta, Melilla y Andorra. En cualquier caso Fábrica se reserva el derecho de utilizar el medio de envío más económico. En las capitales donde Fábrica tenga establecidos depósitos de distribución, esta cláusula se aplicará para las reexpediciones a otras poblaciones de la provincia.

10. IMPORTE MÍNIMO POR PEDIDO

Queda establecido como pedido mínimo la cantidad de 60 € netos. Los pedidos inferiores se cobrarán al contado o por reembolso.

11. RESERVA DE DOMINIO

Nuestras ventas se consideran siempre bajo la condición de Reserva de dominio según el artículo 1.506 C.C. hasta que se haya hecho efectivo íntegramente el pago de todo lo adeudado.

12. JURISDICCIÓN COMPETENTE

Para cualquier discrepancia acerca de la interpretación de estas condiciones o litigio por razón de incumplimiento por cualquiera de las partes se someten ambas al fuero de los Juzgados y Tribunales de Bilbao, con renuncia al que pudiera corresponderles.

13. SISTEMA DE REDONDEO DEL EURO (2 DECIMALES)

La empresa aplica en sus sistemas informáticos la normativa legal vigente en esta materia.

14. NOTA IMPORTANTE SOBRE DISPLAYS MODULARES

Los Displays Modulares son propiedad de IZAR CUTTING TOOLS S.A.L. y la cesión sin costo para su uso a nuestros clientes se hace bajo las siguientes condiciones:

- Pedido inicial del Programa Completo.
- Uso único y exclusivo para los productos suministrados por IZAR CUTTING TOOLS S.A.L.
- Ejercicio de un mantenimiento razonable que evite daños al Display.

El sistema de Displays modulares está patentado por IZAR CUTTING TOOLS S.A.L. La infracción de dicha patente dará lugar a las acciones legales pertinentes.



General Sale Conditions

1. PAYMENT TERMS

Payment transfer within 30 days of invoice date. NET.

2. FIXED DUE DATE

In the case of fixed payment dates that exceed the stipulated deadlines we will use the fixed date, but immediately before, when appropriate, with the maximum period in any event being 60 days from the invoice or shipment date.

3. SAFETY

The goods will travel at the sole risk and expense of the buyer, who also is in charge of premium insurance, in cases where the customer wishes to insure them.

4. COMPLAINTS

Complaints made within 8 days of receipt of the material will be addressed, but no returns will be accepted without the prior knowledge of the Factory.

5. RETURNS

Returns will only be accepted if due to manufacturing defects or errors attributable to IZAR CUTTING TOOLS S.A.L. No returns will be accepted without prior authorisation from the Factory or our delegate or representative. Returns must be via prepaid freight and accompanied by the original invoice. We do not accept returns on promotional products or gift saw blade cases. All returns will incur a debit note of 20% of the product's value for handling purposes and Quality Control inspections.

6. CONDITIONS

Acceptance of the goods without immediate rejection by the buyer implies approval of these general conditions of sale, and any modifications to them shall only be valid if IZAR CUTTING TOOLS S.A.L. agrees in writing.

7. V.A.T.

The prices are subject to Value Added Tax (VAT), while the corresponding surcharge is the customer's responsibility.

8. WARRANTIES

All tools are guaranteed against any manufacturing and material defect, and IZAR cannot be held responsible for any improper use of the tools. In all cases, IZAR's liability is limited to the value of the supplied tool. We reserve the right to modify the dimensions, quality of steel and the

general technical characteristics of the tools without prior notice. No tool can be replaced without a prior report from our Quality Control Department.

9. SHIPPING

Shipments with carriage paid will be provided for all orders with a net invoice value exceeding €180 net per shipment in the mainland and the Balearic Islands; €300 in the Canary Islands, Ceuta, Melilla, and Andorra. In any case, IZAR reserves the right to use the most economical shipping method. In cities where IZAR has established distribution depots, this clause will apply to re-shipping to other towns in the province.

10. MINIMUM ORDER AMOUNT

The minimum order amount is €60 net. Orders priced lower than this will require cash on delivery or be refunded.

11. TITLE RESERVATION

Our sales are always considered to be subject to reserved property rights according to Article 1506 of the Spanish Civil Code until all due payments have been made in full.

12. COMPETENT JURISDICTION

To resolve any discrepancy regarding the interpretation of these conditions, or any litigation due to a breach by either party, both parties shall submit to the jurisdiction of the Courts and Tribunals of Bilbao, waiving any other jurisdiction to which they may otherwise be entitled.

13. EURO ROUNDING SYSTEM (2 DECIMALS)

The company applies the legal regulations in force regarding this matter in its IT systems.

14. IMPORTANT NOTE ABOUT MODULAR DISPLAYS

Modular Displays are the property of IZAR, and the free assignment for their use to our clients is made under the following conditions:

- Initial order of the Complete Program.
- Unique and exclusive use for products supplied by IZAR.
- Exercise of reasonable maintenance to prevent damage to the Display.

The modular Display system is patented by IZAR. Infringement of this patent will lead to the appropriate legal actions.

Conditions Générales de Vente

1. CONDITIONS DE PAIEMENT

Les paiements s'effectuent à 30 jours.

2. ECHEANCES

Quelle que soit la date fixée pour le paiement des factures, celui-ci doit être effectué au maximum 30 jours après l'envoi ou la date de facture.

3. ASSURANCE

Le risque lié à l'envoi des marchandises est assumé exclusivement par l'acheteur, toute latitude lui étant laissée s'il désire les assurer.

4. RECLAMATIONS

Seront prises en compte les réclamations portées à la connaissance de IZAR dans un délai de 8 jours suivant la réception des marchandises. Aucun retour ne sera accepté si cette condition préliminaire n'est pas satisfaite.

5. RETOURS

Seront acceptés les retours de marchandises pour défaut de fabrication ou erreur imputable à IZAR. Ne sera accepté aucun retour de marchandises sans accord préalable de notre part ou de notre représentant.

Les retours s'effectueront port payé et seront accompagnés de la facture originale. En aucun cas ne seront acceptés les retours de marchandises liées à des promotions ou en emballages défectueux. Les avoirs seront minorés de 20% de la valeur de la marchandise pour manipulation et inspection du contrôle de qualité.

6. CONDITIONNALITE

L'acceptation des marchandises de la part de l'acheteur implique l'acceptation de ces conditions générales de vente et leur modification ne sera valable qu'après approbation écrite de la part de IZAR.

7. T.V.A.

Les prix ne sont pas assujettis à la Taxe sur la Valeur Ajoutée.

8. GARANTIES

Tous les outils sont garantis contre les défauts de fabrication, IZAR ne pouvant en aucun cas être rendu responsable en cas d'utilisation inadéquate de ceux-ci. En tout état de cause, notre responsabilité se

limitera à la valeur de l'outil fourni. Nous nous réservons le droit de modifier, sans information préalable, les dimensions, qualités d'acier et en général toutes les caractéristiques techniques des outils. Aucun outil ne sera remplacé sans l'avis préalable de notre département de contrôle de qualité.

9. PORTS

Seront expédiées en franco de port en France Métropolitaine toutes les commandes dont le montant net dépasse les 300 €. IZAR se réserve le droit d'utiliser le moyen de transport le plus économique.

10. MONTANT MINIMUM DES COMMANDES

Le montant minimum des commandes est de 60 € nets.

11. RESERVE DE PROPRIETE

IZAR conserve tous les droits de propriété sur ses ventes jusqu'au paiement intégral des sommes dues.

12. JURIDICTION COMPETENTE

Tout litige relatif à l'interprétation de ces conditions ou au manquement de l'une des parties à ses obligations est de la compétence du Tribunal de Commerce de Bilbao.

13. ARRONDI DE L'EURO (2 DECIMALES)

L'entreprise utilise pour son système informatique la norme légale en vigueur sur ce sujet.

14. NOTE IMPORTANTE SUR LES PRESENTOIRS MODULAIRES

Les présentoirs modulaires sont propriété de IZAR CUTTING TOOLS S.A.L. et leur cession sans coût à nos clients pour leur utilisation se fait sous les conditions suivantes :

- Commande initiale du programme complet.
- Utilisation exclusive de produits fournis par IZAR CUTTING TOOLS S.A.L.
- Entretien raisonnable qui évite les dommages au présentoir













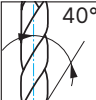











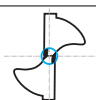
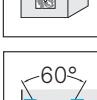







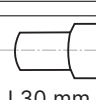
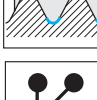







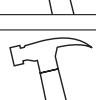
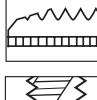

Le système de présentoirs modulaires est breveté par IZAR CUTTING TOOLS S.A.L. Le non-respect dudit brevet donnera lieu aux actions légales nécessaires.



ÍNDICE SÍMBOLOS

Symbol Index

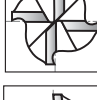
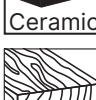
Index de symboles

	Ángulo Punta Point Angle Angle de pointe		Espesor Material Material Thickness Épaisseur matériel		Corte a Izquierda Left hand Cutting Coupe à gauche
	Ángulo de Hélice Helix Angle Angle d'hélice		Espesor Tubo Pipe Thickness Épaisseur tuyau		Magnético Magnetic Magnétique
	Afilado en Cruz Tipo DIN 1412 "C" Split Point DIN 1412 "C" type		Agujero Pasante Through Hole Trou débouchant		Cabezal Zentro4 Zentro4 head Tête Zentro4
	Affûtage en croix type DIN 1412 "C"		Agujero Ciego Blind Hole Trou borgne		Hormigón Reforzado Reinforced Concrete Béton armé
	Punta Centrar DIN 1412 E Center Point DIN 1412 E		Agujero Ciego Blind Hole Trou borgne		Hormigón Concrete Béton
	Pointe à Centrer DIN 1412 E		Rosca Standard Standard Thread Filetage standard		Hormigón Bloque Concrete Block Parpaing
	Mango 3 Planos 3-Flat Shank Attachement 3 plans		Rosca de tubo cilíndrica Straight Pipe Thread Filetage tubes cylindriques		Ladrillo Brick Brique
	Taladro Portátil Portable Drilling Machine Perceuse à main		Rosca Whitworth cilíndrica Straight Whitworth Thread Filetage Whitworth cylindrique		Cabezal 4 Puntas 4-Cutter Head Tête 4 pointes
	Mango Rebajado Reduced Shank Queue réduit		Plástico Plastic Plastique		Punta MD Afilada Carbide Split Point Affûtage pointe carbure
	Punta Metal Duro Carbide Tipped Pointe carbure		Ángulo Avellanado Countersinking- Counterboring Angle Angle de fraisage		Porcelánico Porcelain Porcelaine
	Afilado Universal Universal Point Affûtage universel		Ángulo Avellanado Countersinking- Counterboring Angle Angle de fraisage		Refrigeración Agua Water Cooling Refrigeration eau
	Sin Percusión No Percussion Sans percussion		Entrada Macho Tap Point Entrée de taraud		R.P.M. R.P.M. R.P.M.
	Percusión Percussion Percussion		Ángulo de Hélice Helix Angle Angle d'hélice		Herramienta Diamante Diamond Tool Outil diamant
	Ángulo Broca Escalonada Step Drill Angle Angle de foret etagé		Entrada GUN GUN Chamfer Entrée GUN		Amoladora Disc Grinder Meuleuse
	Conicidad Taper Conicité		Corte al Centro Center Cutting Coupe au centre		Cerámica Ceramics Céramique
	Puntos Soldadura Welding Point Points soudure		Sin Corte al Centro Non Center Cutting Sans coupe au centre		Madera Wood Bois
					Vidrio Glass Verre



ÍNDICE SÍMBOLOS

Symbol Index

Index de symboles

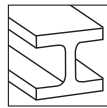

Metal
Metal
Métal

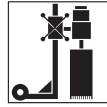

Máquina Perforadora
Core Drilling Machine
Carotteuse électrique

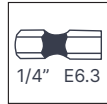

Inserción Rápida 1/4
Quick Shank 1/4
Attache rapide 1/4



Bujía
Spark Plug
Bougie



Abrasivos
Abrasives
Abrasisifs



Pulido
Sanding
Poncer

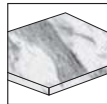

Mármol
Marble
Marbre



Perfil Parabólico "S"
S Parabolic Profile
Profil parabolique S



Madera Blanda
Soft Wood
Bois tendre



Madera Dura
Hard Wood
Bois dur



Contrachapado
Plywood
Contreplaqué

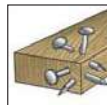

Madera+Clavos
Wood+Nails
Bois+Clous

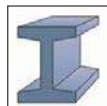

Metal
Metal
Métal

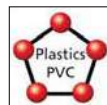

Plástico
Plastics
Plastique



Cristal
Glass
Verre



Mango Impacto
Impact Shank
Queue Impact

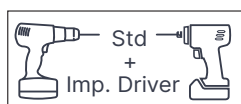

Válido Atornillador Impacto + Taladro normal
Suitable for Impact Driver + Standard Drill
Valide pour Visseuse Impact + Perceuse standard



Válido Mango Multi-Función
Multi-Tool
Multifonction



Fibra Vidrio
Fibreglass
Fibre verre

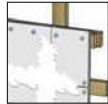

Pladur
Drywall
Plâtre

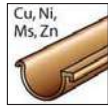

No ferrosos
Non-ferrous
Non ferreux

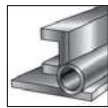

Perfiles
Profiles
Profils



Parquet-Laminados
Laminated-Parquet
Parquet-laminés

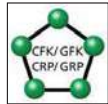

GFK

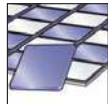

Cerámica
Ceramics
Céramique

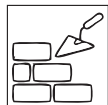

Grout-Mortero
Grout-Mortar
Coulées-Mortier

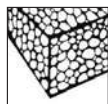

Aislamiento
Isolating
Isolant

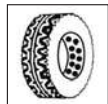

Caucho
Rubber
Caoutchouc

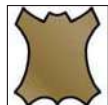

Cuero
Leather
Cuir



Restos blandos (pegamento, moqueta, silicona...)

Soft remains (glue, carpet, silicone...)
Restes tendres (colle, moquette, silicone...)

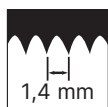

Distancia entre Dientes
Distance among Teeth
Distance entre les dents

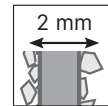

Espesor Dentado
Teeth Thickness
Épaisseur denture

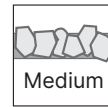

Tipo Dentado
Teeth Type
Type denture

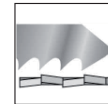

Dentado Alterno Basto
Rough Side Teeth
Denture avoyée gros

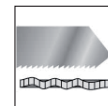

Dentado Ondulado Fino
Fine Wavy Teeth
Denture ondulé fin

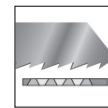

Dentado Rectificado Cónico
Conically Ground Teeth
Denture conique dépoluillée

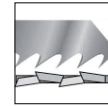

Dentado Alterno Diagonal
Diagonally Side Teeth
Denture avoyée diagonale



Punta Atornillar HEX
HEX Screwdriver Bit
Embout vissage HEX



Punta Atornillar PH
PH Screwdriver Bit
Embout vissage PH



Punta Atornillar PZ
PZ Screwdriver Bit
Embout vissage PZ



Punta Atornillar SL
SL Screwdriver Bit
Embout vissage SL



Punta Atornillar Tx
Tx Screwdriver Bit
Embout vissage Tx



Punta Atornillar Ts
Ts Screwdriver Bit
Embout vissage Ts



P. Atornillar SQUARE ROBERTSON
SQUARE ROBERTSON Screwdriver Bit
Embout vissage SQUARE ROBERTSON



Punta Atornillar TRIWING
TRIWING Screwdriver Bit
Embout vissage TRIWING



Punta Atornillar XZN
XZN Screwdriver Bit
Embout vissage XZN



Entrada Hexagonal
HEX Input
Entrée hexagonale



Búsqueda por referencia (Ref. - Página)

Search by reference (Ref. - Page)

Recherche par référence (Ref. - Page)

Ref.	Pag.	Ref.	Pag.	Ref.	Pag.	Ref.	Pag.	Ref.	Pag.	Ref.	Pag.	Ref.	Pag.
1001	58			1636	128	1804	93	1950	382	3404	176	8335	233
1002	69	1459	21-27-34-42-51-61-72	1637	88	1806	93	1960	390	3405	176	8341	233
1003	84			1639	313	1807	92	1994	217	3406	177	8342	235
1004	25	1460	275-303	1640	300	1809	95	1996	217	3407	356-427	8345	236
1005	40	1461	88-331-343-350-428	1641	298	1819	95	1997	217	3409	179	8350	232
1006	32			1642	284	1821	267	1999	217	3415	180	8351	230
1007	75			1643	311	1834	342					8352	229-338
1009	87	1462	21-27-34-42-51-61-72-77	1644	310	1836	276	2010	129	3500	165		
1010	53			1645	277	1839	340			3502	172	8900	219
1012	76			1646	284	1846	269	2530	131	3506	173	8901	219
1013	65	1466	21-27-34-42-51-61-64-72-74-77	1647	280	1849	293	2572	132	3510	169	8904	220
1015	47			1650	306-348	1851	288	2575	130	3536	168	8910	220
1016	28			1651	304-346	1852	288			3546	172	8920	221
1020	37			1653	304-347	1853	290	2900	376	3560	171	8925	221
1021	22	1470	36-63-73	1654	345	1854	289	2910	365			8930	222
1022	20			1655	308	1855	290	2930	370	3610	334	8940	222
1025	77	1476	81	1659	126	1857	291	2940	361	3650	335	8950	223
1027	43	1482	259	1660	78	1858	289	2950	378			8960	223
1030	82	1485	275	1661	282	1860	286	2960	379	3900	175	8970	224
1032	19	1486	271	1662	283	1861	291			3912	174	8990	225
1040	86	1487	271	1663	126	1862	292	3001	143			8991	225
1050	81	1488	275	1664	124-128	1863	293	3003	134	4060	121	8992	226
1052	80	1489	241	1665	127	1864	292	3005	167	4061	122		
1065	50	1490	87	1667	124	1869	241	3006	167	4062	123		
1090	87	1491	87	1669	314	1870	255	3010	140	4067	120	9015	44
		1492	87	1670	316	1871	258	3012	150	4070	112	9016	178
		1494	246	1671	316	1872	256	3016	152	4071	113		
1101	97	1497	246	1672	317	1875	253	3020	138	4072	114	9100	46
1102	97	1499	87	1673	317	1876	264	3023	144	4073	117	9200	203
1103	98			1674	315	1877	263	3026	151	4074	117	9201	205
1104	98	1510	425	1676	315	1879	261	3030	133	4075	110/123	9230	194
1110	89	1520	418	1677	316	1880	272	3032	149	4076	116	9231	195
		1521	422	1678	315	1882	259	3036	136	4077	111	9237	198
1404	35-52-62-73	1523	352-423	1679	314	1883	262	3037	136	4078	110	9238	199
1405	35-52-62-64	1524	353-424	1681	317	1886	268	3039	146	4079	115	9240	193
1406	35-52-62-73	1527	355-425	1682	318	1890	242	3040	145			9247	201
1407	35-62-64	1529	354-426	1685	314	1891	238			4223	211	9248	202
1408	35-52-62-64	1601	343	1686	318	1892	248	3100	153	4228	214	9250	194
1409	35-54-62-64	1602	100	1689	323	1894	250	3103	163	4229	216	9251	195
1410	36-52-63-73	1603	105	1690	326	1899	246	3109	159			9252	196
1435	303	1604	107	1692	312			3113	158	4412	209	9254	196
1438	303	1605	107	1695	247	1910	407	3119	157	4414	209	9255	197
		1606	107	1696	247	1915	415	3123	164			9256	197
		1607	103	1697	251	1920	385	3150	155	7001	325	9257	198
		1609	106	1698	251	1930	412	3157	161	7002	324	9258	199
		1610	108	1699	276	1940	398	3181	175	7003	325	9260	193
		1611	331			1945	413	3184	175	7009	324	9266	200
		1612	102	1802	92			3191	174			9267	201
		1613	330	1803	94					8301	227	9268	202
		1614	336					3200	154	8302	227	9289	44
		1615	320					3250	156	8303	227		
		1616	329							8304	227	9411	208
		1617	104					3300	187	8309	294	9419	208
		1620	321					3303	189	8310	228	9459	207
		1621	349					3305	188	8318	294		
		1622	333					3307	189	8319	295-296	9674	206
		1625	322					3310	190	8320	294-295		
		1635	337					3311	190	8321	234-235	9994	99
								3312	191	8325	233		
										8326	234		
										8330	233		
										8331	294-295-296		



Búsqueda por referencia (Display - Página)

Search by reference (Display - Page)

Recherche par référence (Display - Page)

Display	Pag.	Display	Pag.	Display	Pag.	Display	Pag.	Display	Pag.	Display	Pag.
D-01	243	D-15	85	D-29	245	D-43	167	D-55	299-305	D-68	240
D-02	243	D-16	41	D-30	245	D-44	135	D-56	305-347	D-69	263
D-03	249	D-17	70	D-31	241	D-45	244	D-57	305-347	D-70	260
D-04	257	D-18	75	D-32	241	D-46	59	D-58	299	D-71	420
D-05	247	D-19	278	D-33	249	D-47	71	D-59	71-274-302	D-72	265
D-06	251	D-20	416	D-34	249	D-48	33	D-60	281	D-73	20
D-07	270	D-21	416	D-35	257	D-49	41	D-61	240	D-74	329
D-08	273	D-22	135	D-36	257	D-50	26	D-62	26	D-75	330
D-09	265-273	D-23	270-302	D-37	260	D-51	60-274-301	D-63	420	D-76	337
D-10	301-307	D-24	33-60	D-38	309	D-52	26-270-299	D-64	319	D-77	340
D-11	309	D-25	244	D-39	309	D-53	377	D-65	125	D-78	334
D-12	96	D-26	244	D-40	309	D-54	349	D-66	127	D-79	333
D-13	33	D-27	245	D-41	311			D-67	240		
D-14	59	D-28	245	D-42	311						

Búsqueda por referencia (Línea - Página)

Search by reference (Line - Page)

Recherche par référence (Ligne - Page)

Línea	Pag.	Línea	Pag.	Línea	Pag.
L-1001-1 m	59	L-1625	322	L-2530	131
L-1002-1 m	70	L-1635	337	L-2572	132
L-1003-1 m	85	L-1639	313	L-2575	130
L-1004-1 m	25	L-1640-1 m	300	L-2900-1 m	377
L-1005-1 m	41	L-1641	298	L-3001	143
L-1006-1 m	32	L-1644-1 m	310	L-3003	134
L-1007-1 m	75	L-1645-1 m	278	L-3023	144
L-1010-1 m	56	L-1647-1 m	281	L-3109-1	160
L-1013-1 m	67	L-1650-1 m	307-348	L-3109-2	160
L-1015-1 m	49	L-1651-1 m	304-347	L-3119	157
L-1016-1 m	30	L-1654	345	L-3157-1	162
L-1020-1 m	38	L-1655-1 m	308	L-3157-2	162
L-1021-1 m	23	L-1667-1 m	125	L-3191	174
L-1027-1 m	43	L-16FM-1 m	319	L-3409	179
L-14S1	60-271-275-303	L-1821	267	L-3500	166
L-14S2	246-271-275	L-1834	342	L-3510	169
L-1601	343	L-1836	276	L-3536	168
L-1602	101	L-1839	340	L-3610	334
L-1603	105	L-1846-1 m	269	L-3650	335
L-1607	103	L-1870	257	L-3912	174
L-1609	106	L-1879	261	L-4060	121
L-1610	108	L-1880-1 m	272	L-4061	122
L-1611	331	L-1883-1 m	262	L-4062	123
L-1612	102	L-1886-1 m	268	L-4067	120
L-1614	336	L-1890-1 m	243	L-4070	112
L-1615	320	L-1891-1 m	239	L-4071	113
L-1617	104	L-1892-1 m	248	L-4072	114
L-1620	321	L-18PB	96	L-4076	116
L-1621	349	L-18PB-1 m	96	L-4077	111
L-1622	333	L-19C1-1 m	416	L-4078	110
		L-19C2-1 m	416	L-4079	115
		L-19SS-1 m	395	L-9200	204





IZAR CUTTING TOOLS, S.A.L.

C.I.F.: A-48932826

Parque Empresarial Boroa 2B2

48340 AMOREBIETA (Bizkaia)

Spain

izartool.com

COMERCIAL NACIONAL ✉ comercial@izartool.com

**PEDIDOS Y
ATENCIÓN A CLIENTES** ☎ 94 630 02 41

SERVICIO TÉCNICO ☎ 94 630 02 43

EXPORT SALES ✉ export@izartool.com

**ORDERS & CUSTOMER
ASSISTANCE** ☎ +34 94 630 02 46

VENTES FRANCE ✉ france@izartool.com
☎ +34 94 630 02 45



izartool.com



Todas nuestras
publicaciones se
imprimen en papel
ecológico procedente de
fuentes responsables de
con el medioambiente
y la sociedad.

All our publications
are printed on
ecological paper
from environmentally
and socially responsible
sources.

Toutes nos publications
sont imprimées sur du
papier écologique issu de
sources écologiquement
et socialement
responsables.