

Euromac[®] system

TC PUNZONES Y MATRICES
www.tcpunzones.com
Tlf. +34 934 228 023
info@tcpunzones.com

Euromac System

Tipo A <i>Type A</i>	pág. 3
Tipo A Porta Punzón Intercambiable <i>Type A Punch Holder Insert</i>	pág. 4
Tipo B <i>Type B</i>	pág. 5
Tipo B Porta Punzón Intercambiable <i>Type B Punch Holder Insert</i>	pág. 6
Tipo C <i>Type C</i>	pág. 7
Tipo D <i>Type D</i>	pág. 8
Tipo C y D Porta Cuchillas y Cuchillas <i>Type C & D Blade Holder & Blades</i>	pág. 9
Porta Punzones Múltiple <i>Cluster Punch Holder</i>	pág. 10
Multi Tools <i>Multi Tools</i>	pág. 11
Avellanadores <i>Countersinks</i>	pág. 14
Embutidores <i>Form Tools</i>	pág. 15
Reductoras <i>Adapters Tool</i>	pág. 17
Porta Matrices Máquina <i>Die Holder for Machine</i>	pág. 18

Información Técnica / Tecnic information

Figuras Especiales <i>Special Shapes</i>	pág. 19
Embuticiones <i>Forming Tools</i>	pág. 21
Múltiples <i>Clusters</i>	pág. 23
Tolerancia y Tonelaje <i>Clearance & Tonnage</i>	pág. 25
Tipo de Rectificado <i>Grinding type</i>	pág. 26
Tratamientos Superficiales <i>Coating Solutions</i>	pág. 27
Mantenimiento <i>Maintenance</i>	pág. 28
Servicio TC <i>TC Service</i>	pág. 29

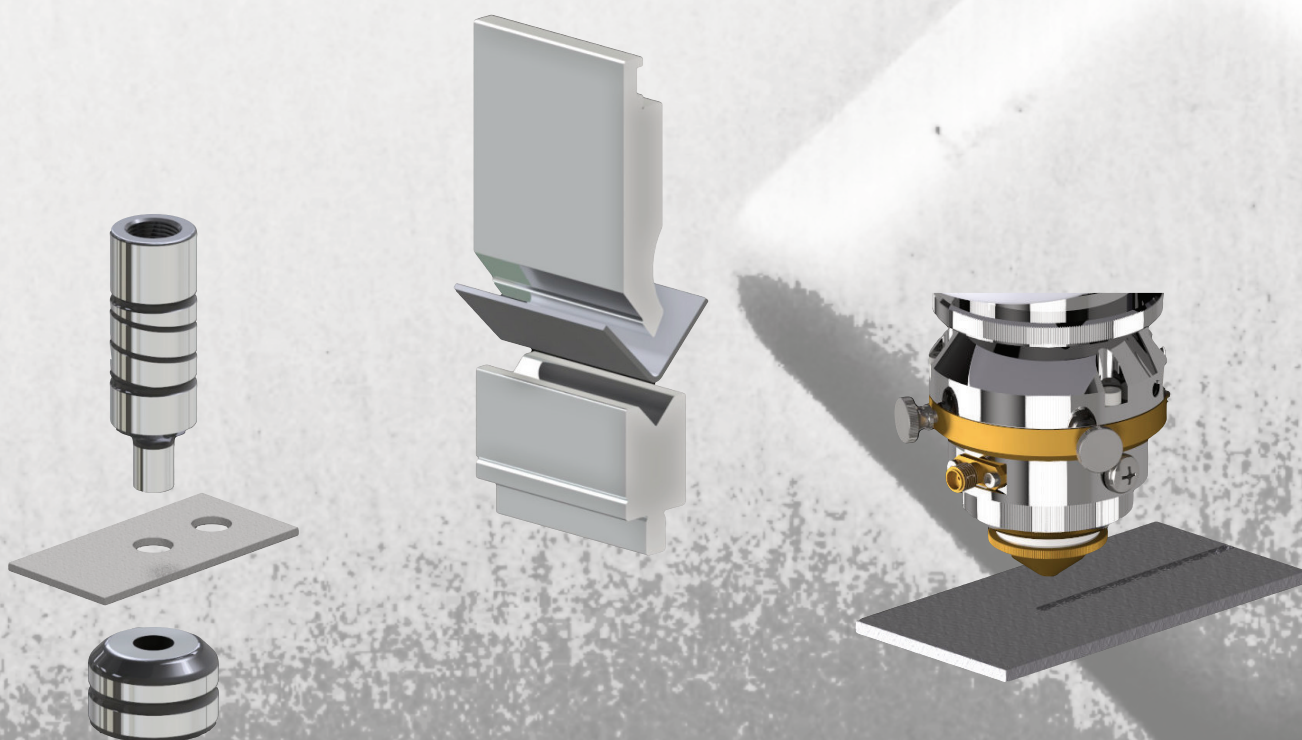



Sistema largo / Thick turret

***Tipo De Sistema
Por Posición Chaveta**
*System Type For
Key Position

59.5mm
Sistema HP
HP system

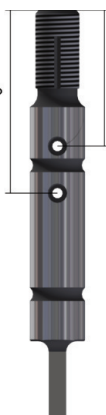

39mm
Sistema
WLS
WLS system



Sistema WT / WT system

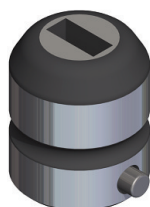

Sistema UT / UT system

- **Figura máxima inscrita en Ø12,7mm**
 - *Maximum shape inscribed in Ø12,7mm*
 - **Suplementos de matriz de espesor**
 - *Die supplement Shims*
- 0,3 - 0,5 mm**

Sistema largo / Thick turret



*Porta Punzón
Sistema Largo
Punch Holder
Thick Turret System*

*Punzón
Intercambiable Ø6
Insert Punch Ø6*

*Casquillo Porta Punzón
Punch Holder Cap*

Sistema WT / WT system



*Porta Punzón
Sistema WT
Punch Holder
WT System*

*Punzón
Intercambiable Ø6
Insert Punch Ø6*

*Casquillo Porta Punzón
Punch Holder Cap*

Sistema UT / UT system



*Porta Punzón
Sistema UT
Punch Holder
UT System*

*Punzón
Intercambiable Ø6
Insert Punch Ø6*

*Casquillo Porta Punzón
Punch Holder Cap*

Sistema largo / Thick turret



Sistema Estándar
Standard System

Sistema BR
Heavy duty BR System

Sistema WT / WT system

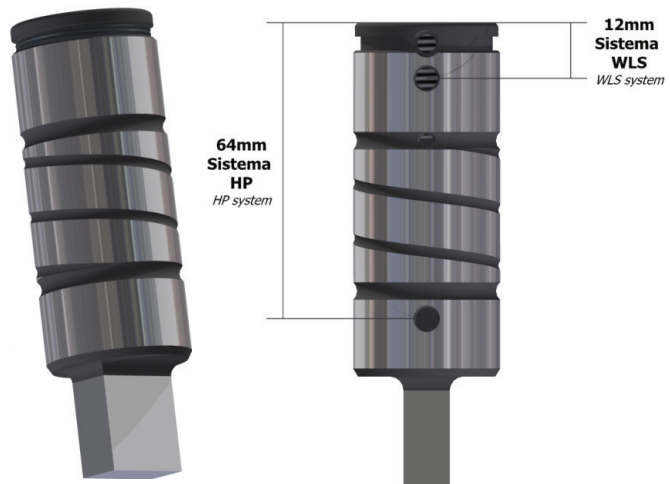

Sistema UT / UT system

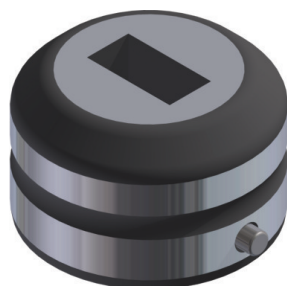

- Figura máxima inscrita en Ø31,7mm
 - Maximum shape inscribed in Ø31,7mm
 - Suplementos de matriz de espesor
 - Die supplement Shims
- 0,3 - 0,5 mm**

Sistema largo / Thick turret



Vástago largo
Thick Turret Stem

Punzón
Intercambiable Ø10
Insert Punch Ø10

Porta Punzón
Sistema Largo
Punch Holder
Thick Turret System

Sistema WT / WT system



Punzón
Intercambiable Ø10
Insert Punch Ø10

Porta Punzón
Sistema WT
Punch Holder
WT System

Sistema UT / UT system



Punzón
Intercambiable Ø10
Insert Punch Ø10

Porta Punzón
Sistema UT
Punch Holder
UT System

- Figura máxima inscrita en Ø10mm
- Maximum shape incised in Ø10mm

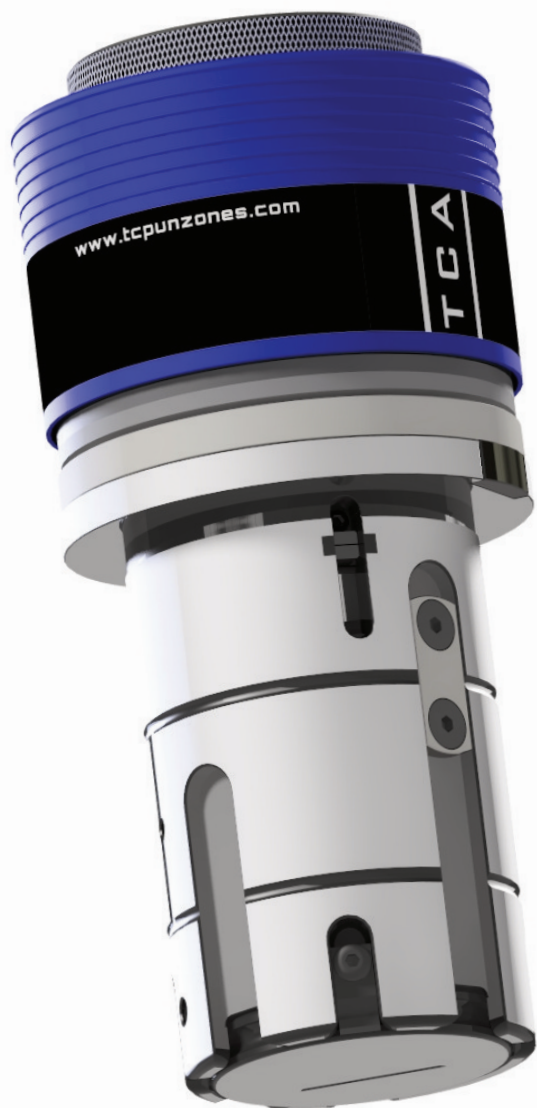

Sistema largo / Thick turret

Sistema UT / UT system

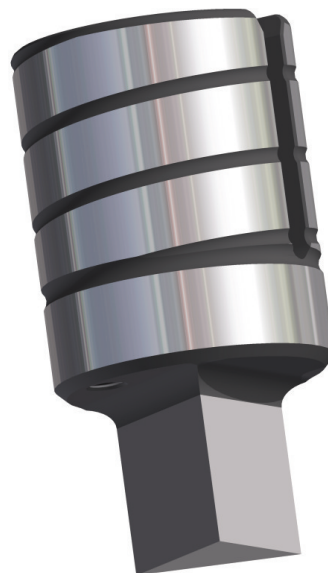

Sistema WT / WT system

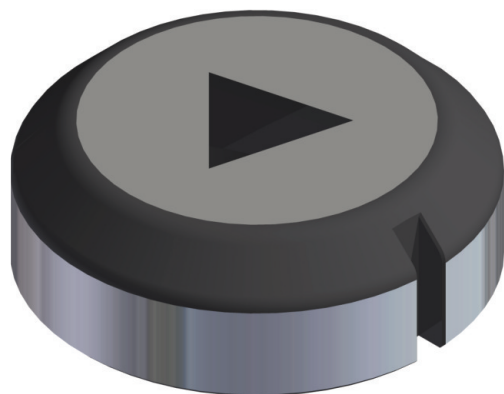
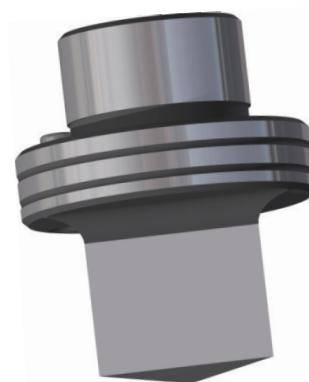

- **Figura máxima inscrita en $\varnothing 50,8\text{mm}$**
- *Maximum shape inscribed in $\varnothing 50,8\text{mm}$*
- **Suplementos de matriz de espesor**
- *Die supplement Shims*
- 0,3 - 0,5 mm**



Sistema largo / Thick turret

Sistema UT / UT system

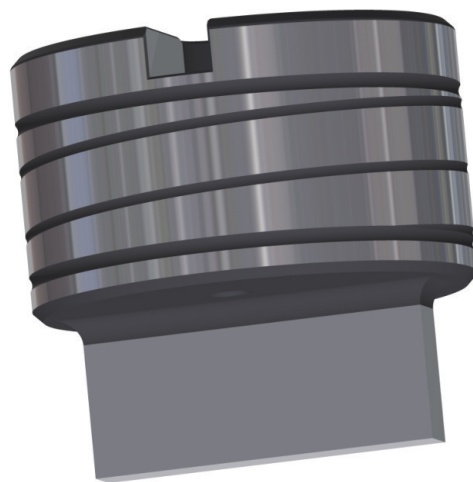

Sistema WT / WT system

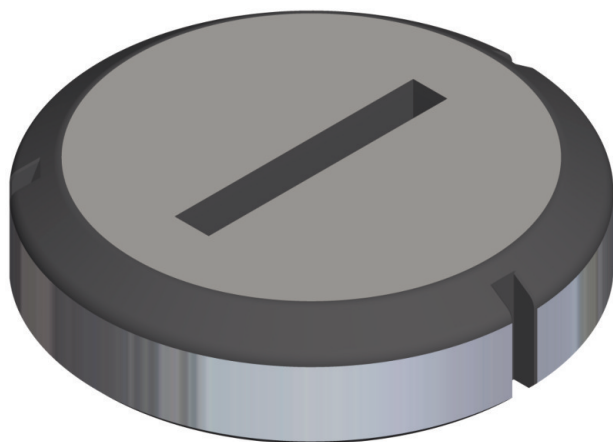
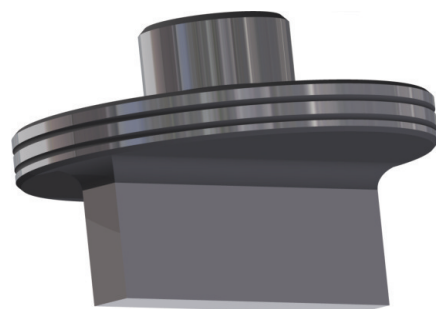

- Figura máxima inscrita en $\text{Ø}88,9\text{mm}$

- Maximum shape inscribed in $\text{Ø}88,9\text{mm}$

- Suplementos de matriz de espesor

- Die supplement Ring

0,3 - 0,5 mm

Tipo C y D Porta Cuchillas / Type C & D Blade Holder

Tipo C / Type C

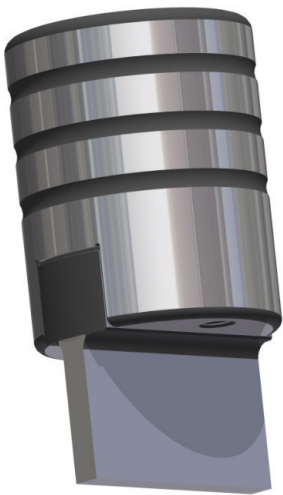

Cuchilla Estándar / Standard Blade

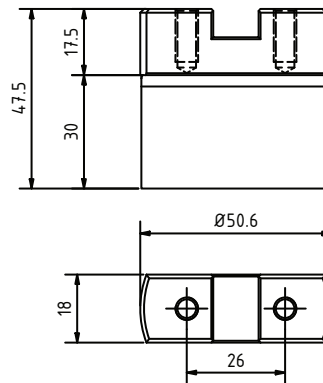

Tipo D / Type D

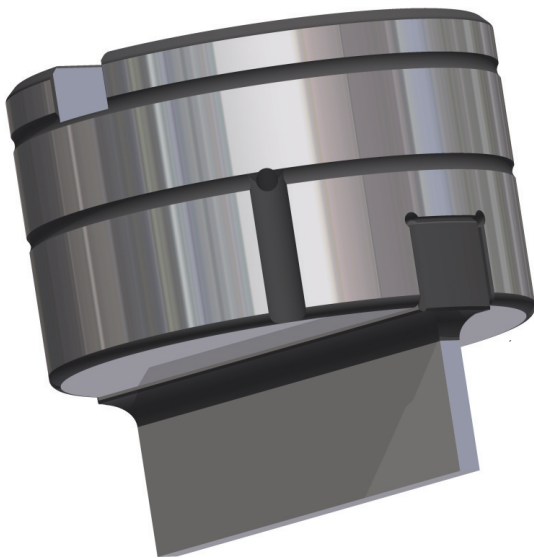

Cuchilla Estándar / Standard Blade

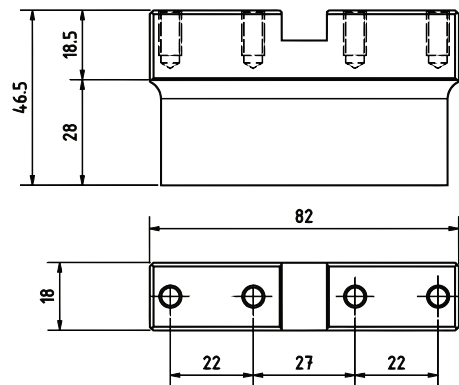

Cuchilla TC / TC Blade

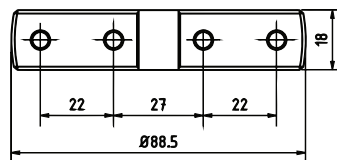
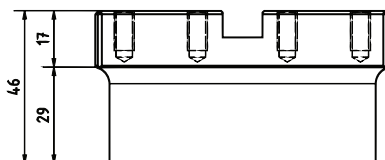

Cuchilla UT / UT Blade

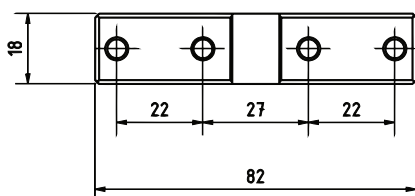
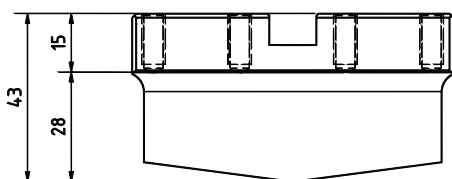

Cuchilla WT / WT Blade

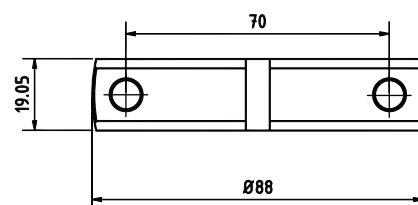
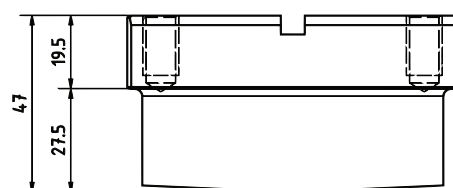

Porta Punzones Múltiples / Cluster Punch Holder

Tipo B / Type B
Sistema largo / Thick turret

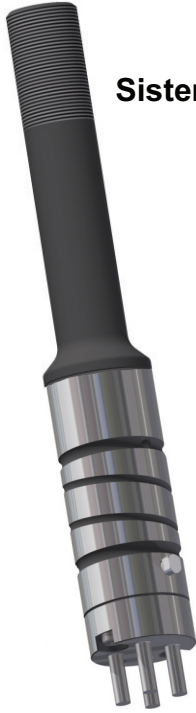

Tipo B / Type B
Sistema WT / WT system

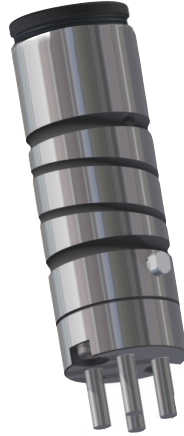

Tipo B / Type B
Sistema UT / UT system



Tipo C / Type C
Sistema largo / Thick turret
Sistema UT / UT System



Tipo D / Type D
Sistema largo / Thick turret
Sistema UT / UT System



Tipo C / Type C
Sistema WT / WT system

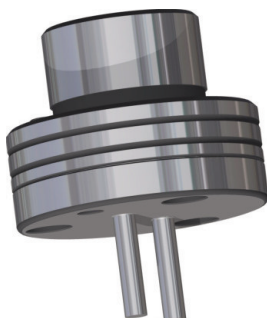

Tipo D / Type D
Sistema WT / WT system

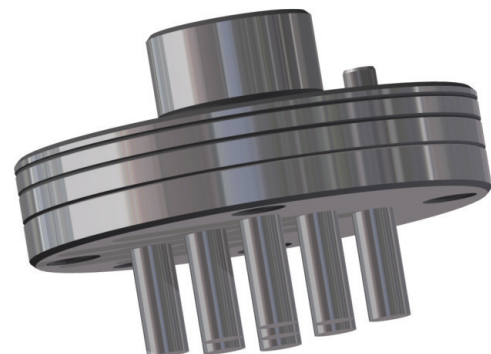

Todos los múltiples requieren un estudio previo.
All clusters needs previus study.

Punzón L=71mm
Punch Legth 71mm

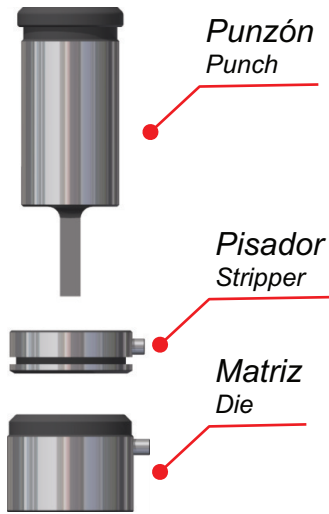

Punzón L=100mm
Punch Legth 100mm
MT 6/8 Ø24 EUROMAC



XMTE-10 Ø12,7
EUROMAC

- Figura máxima inscrita en Ø12,7mm
- Maximum shape inscribed in Ø12,7mm



Punzón L=113,5mm
Punch Legth 113,5mm
MT 6/8 Ø24 DURMA

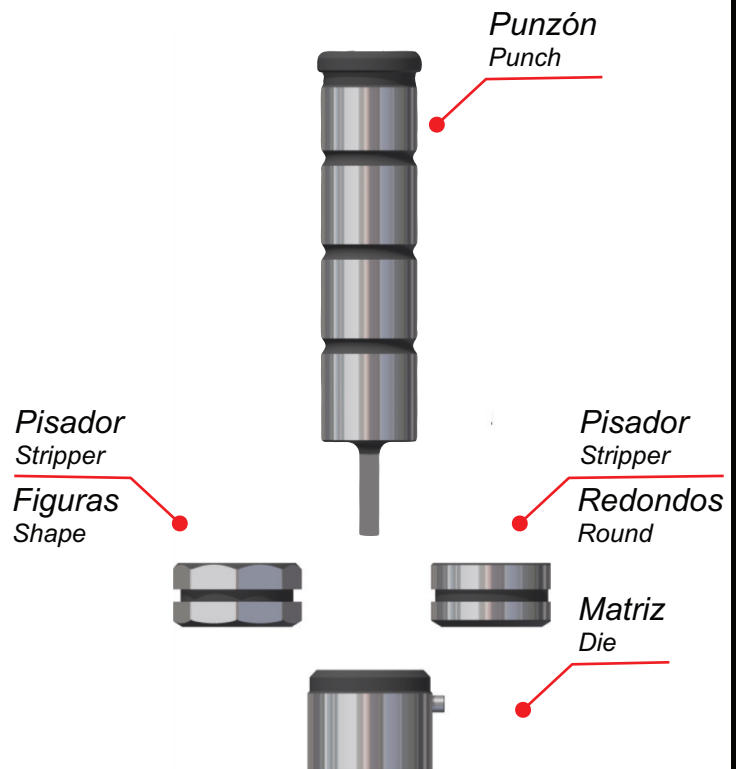

- **Figura máxima inscrita en Ø24mm**
- Maximum shape inscribed in Ø24mm
- **Suplementos de matriz de espesor**
- Die supplement Shims
0,3 - 0,5 mm

Porta Punzón L=71mm Intercambiable max. Ø10

Insert Punch Holder L=71mm max. Ø10

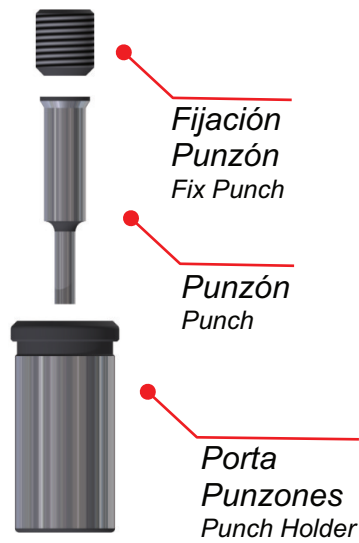

Porta Punzón L=100mm Intercambiable max. Ø10

Insert Punch Holder L=100mm max. Ø10

EUROMAC

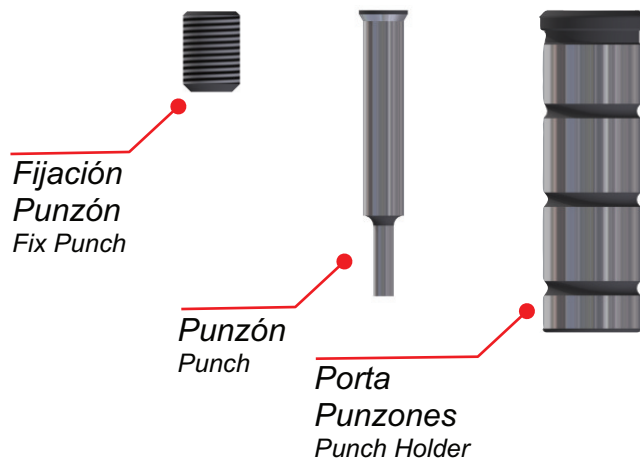

Porta Punzón L=113,5mm Intercambiable max. Ø10

Insert Punch Holder L=113,5mm max. Ø10

DURMA

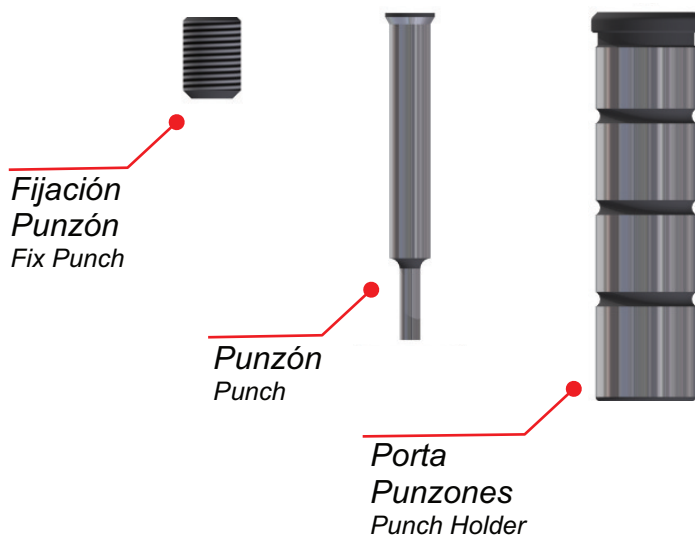



Cabeza de Golpeo XMTE - 4B
Head Punch XMTE - 4B

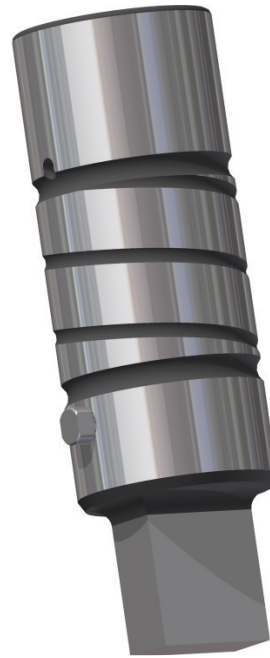

Punzón Tipo B Sistema UT
System Punch Type B UT



Pisador Tipo B UT
Stripper Type B UT

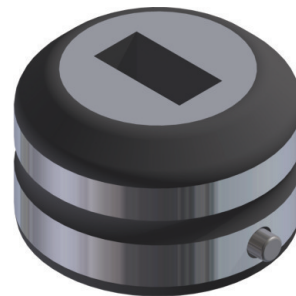

Matriz Tipo B
Die Type B

- **Figura máxima inscrita en $\varnothing 31,7\text{mm}$**
- *Maximum shape inscribed in $\varnothing 31,7\text{mm}$*
- **Suplementos de matriz de espesor**
- *Die supplement Shims*
- 0,3 - 0,5 mm**

- Los avellanadores se componen de punzón+pisador+matriz
- The countersinks are composed of punch+stripper+die
- Es necesario un taladro previo al avellanado
- It is necessary pre-punch before countersink

Avellanadores hacia abajo Down direction countersink

*Todos los tipos y MT (previo estudio)

* All types and MT (previous study)



Avellanadores hacia arriba Up direction countersink

* tipo B - C - D - MT6/8 Ø24 (previo estudio)

* Type B - C - D - MT6/8 Ø24 (previous study)

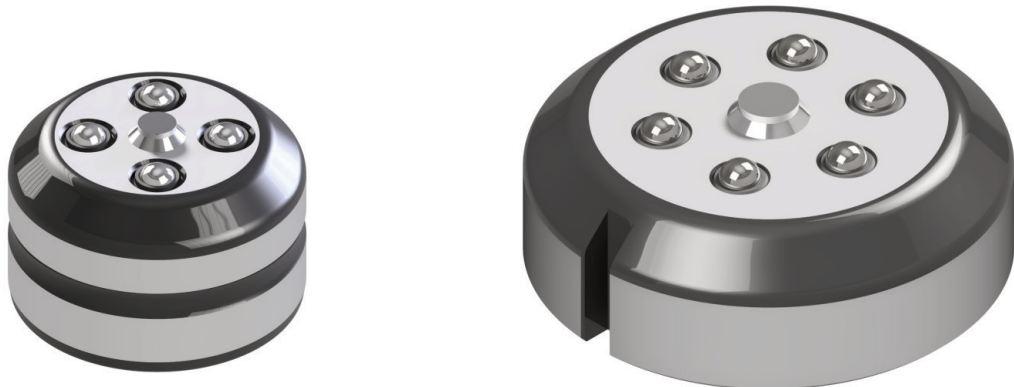



Tipo B Embutidor
Type B Form Tool



Tipo B Roller
Type B Roller Tool

Roller Nervio
Rib Roller
Roller Incisor
Incisor Roller
Roller Reborde
Offset Roller
Roller Escritura
Marking Roller



Tipo C Embutidor
Type C Form Tool

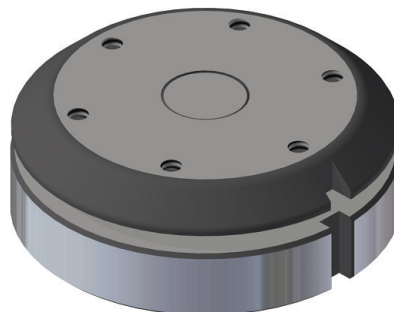

-Todos los embutidores requieren un estudio previo.
-All form tools needs previous study.
-Figuras embutidas estándar ver pág. 21-22.
-Standard forms look at page 21-22.
-La imagen mostrada es un ejemplo de embutidor.
-The image show is an example of form tool.



Tipo D Embutidor
Type D Form Tool

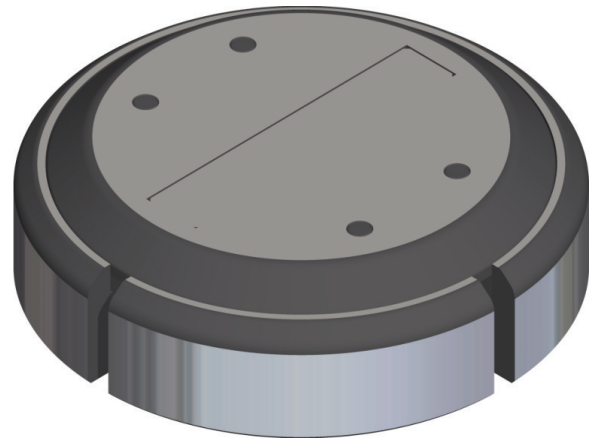

Tipo LOGOS
Type MARK Tool



- Alto relieve y estampado.
-High relief and marking.
- Dirección tanto hacia arriba como hacia abajo.
-Up and down direction of form.
- Tamaño de tipo dependiendo del logo o forma.
-Size of type depending of the mark.

- Todos los embutidores requieren un estudio previo.
-All form tools needs previous study.
- Figuras embutidas estándar ver pág. 21-22.
-Standard forms look at page 21-22.
- La imagen mostrada es un ejemplo de embutidor.
-The image show is an example of form tool.

Reductoras / Adapter Tool

Reductora de B a A
Adapter of B to A



Reductora de C a B
Adapter of C to B

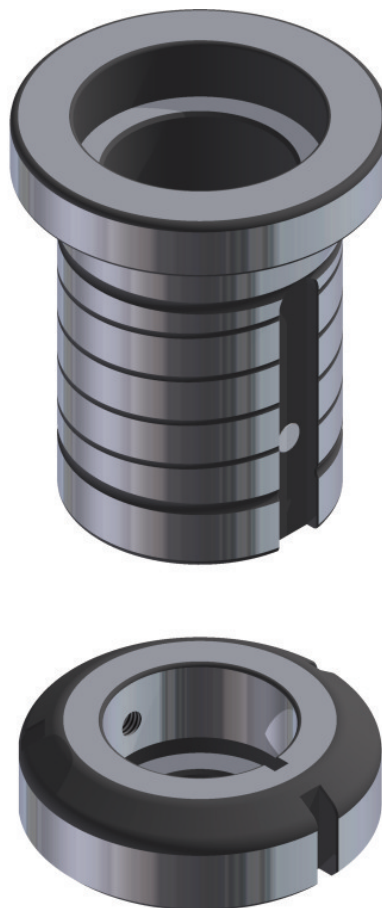

Reductora de D a B
Adapter of D to B

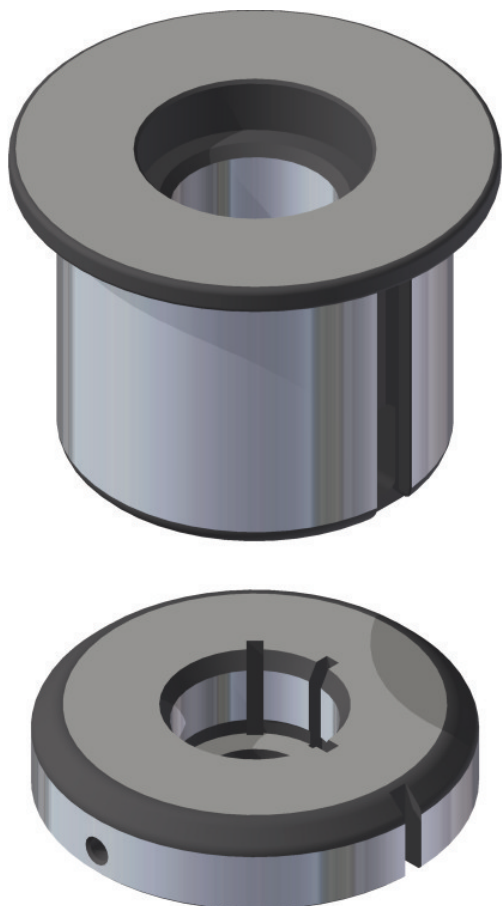

Reductora de D a C
Adapter of D to C

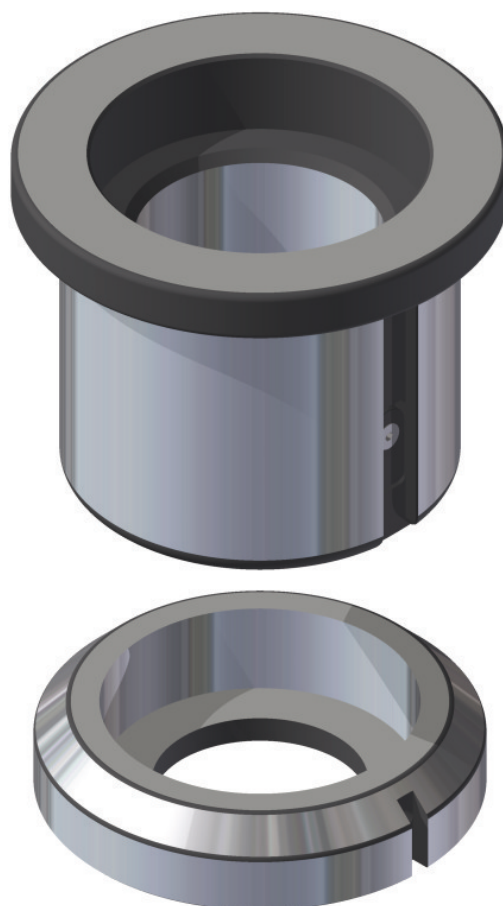

EUROMAC[®]

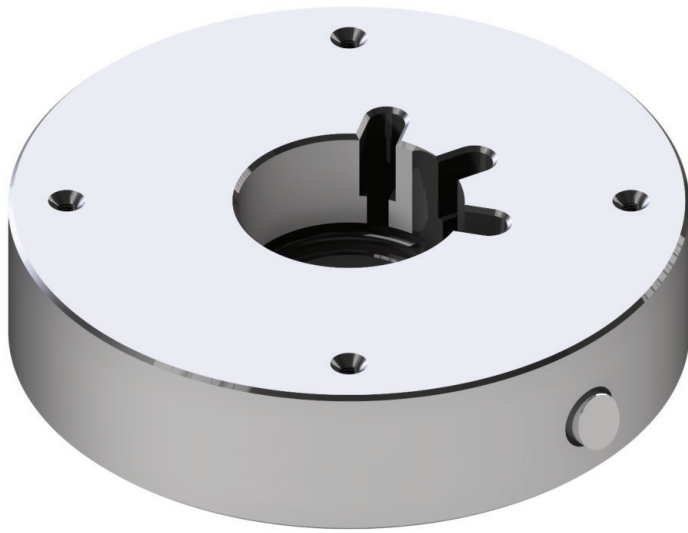

Porta Matriz Tipo B
Die Holder Type B



Porta Matriz Tipo C
Die Holder Type C



Porta Matriz Tipo D
Die Holder Type D



**Disponibles porta matrices
Para máquinas antiguas
Available die Holder for old
machines.



Accesorio porta matriz
Die Holder accesories

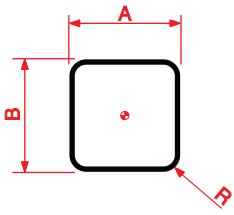

B1

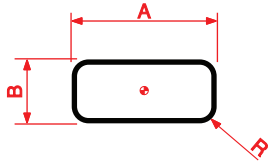

B2

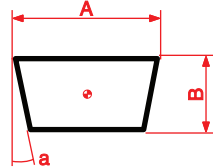

B3

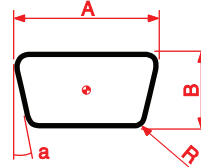

B4

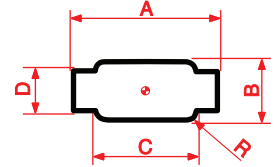

B5

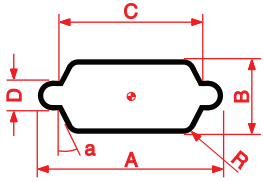

B6

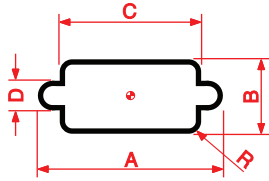

B7

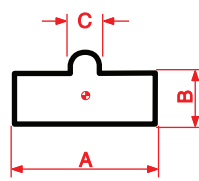

B8

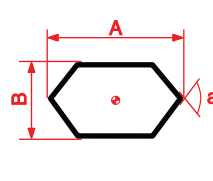

B9

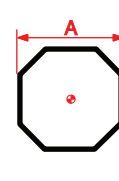

B10

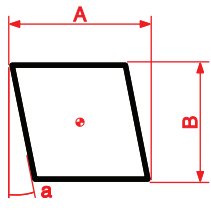

B11

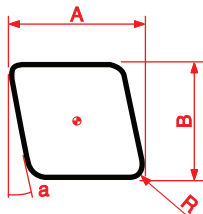

B12

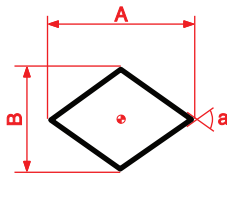

B13

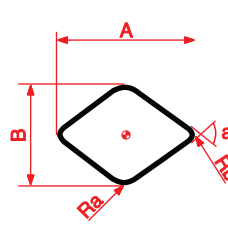

B14

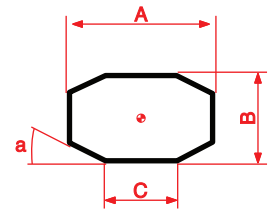

B15

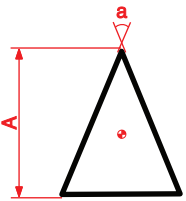

B16

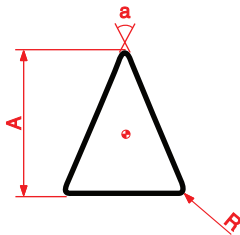

B17

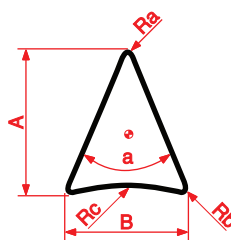

B18

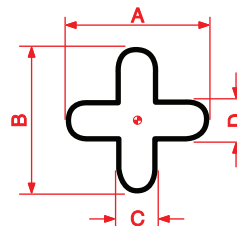

B19

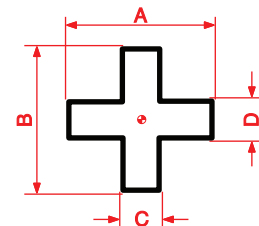

B20

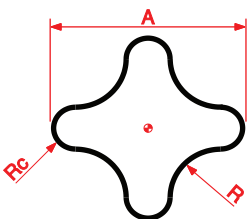

B21

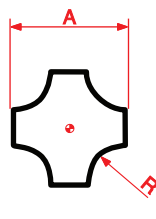

B22

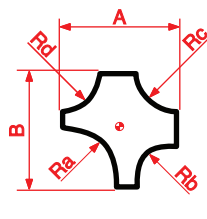

B23

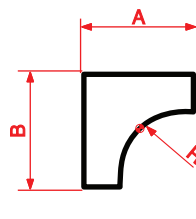

B24

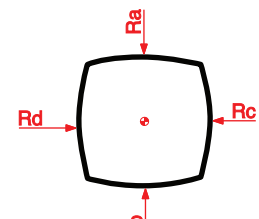

B25

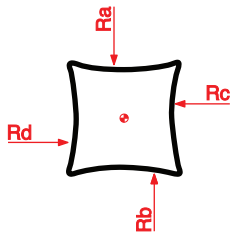

B26

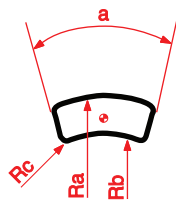

B27

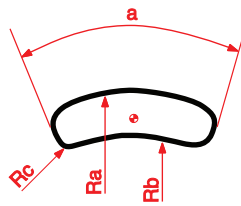

B28

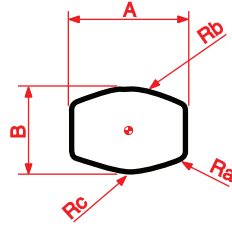

B29

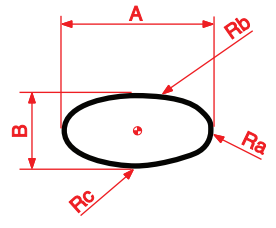

B30

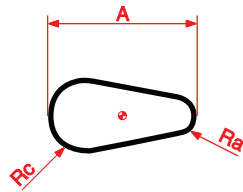

B31

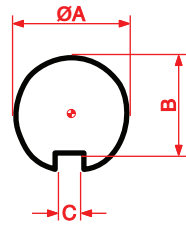

B32

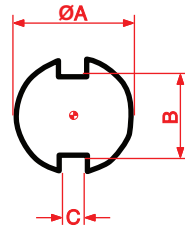

B33

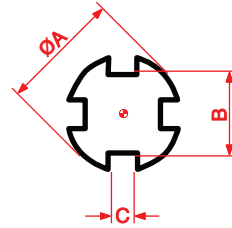

B34

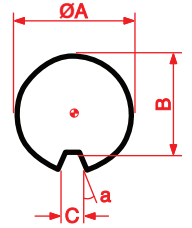

B35

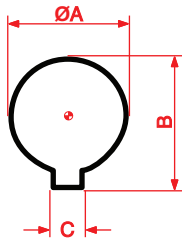

B36

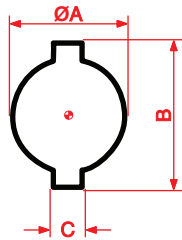

B37

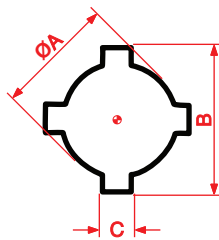

B38

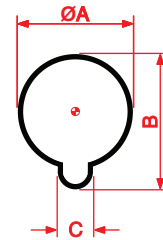

B39

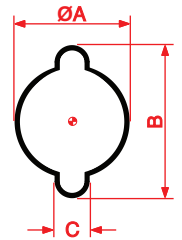

B40

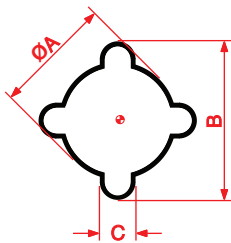

B41

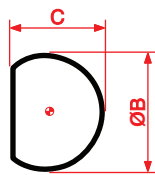

B42

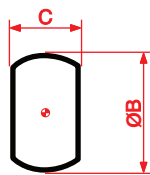

B43

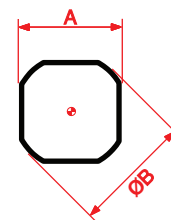

B44

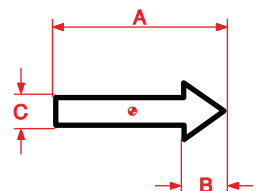

B45

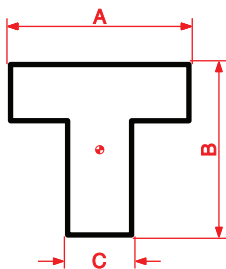

B46

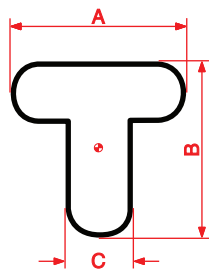

B47

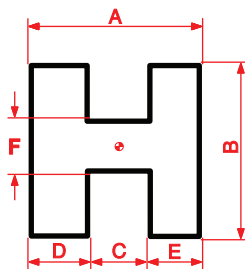

B48

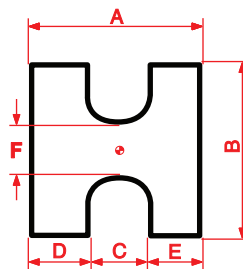

B49

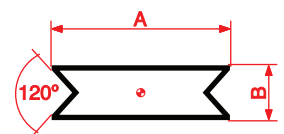

B49-A

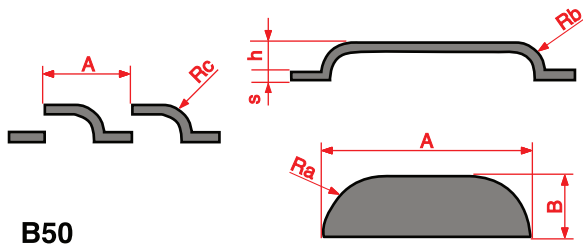

B50

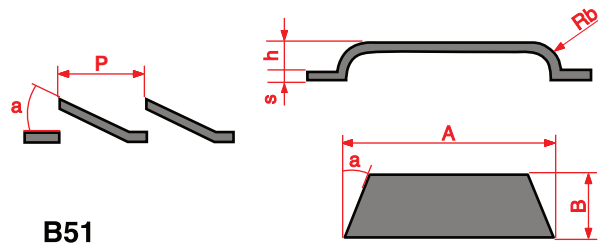

B51

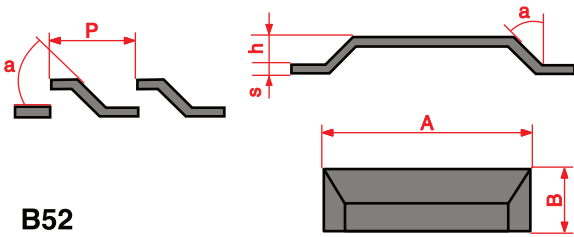

B52

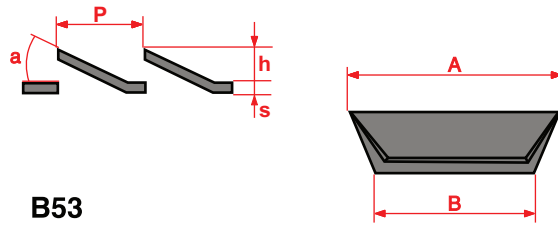

B53

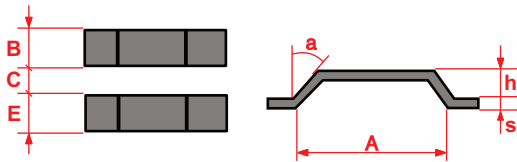

B54

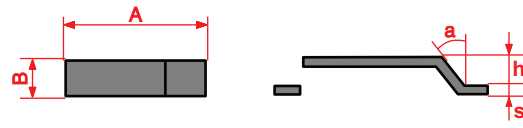

B55

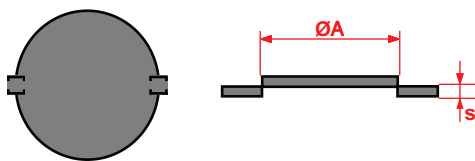

B56*

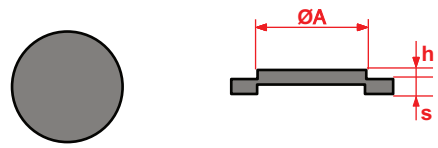

B57

***Simple o Doble**
*Single or double

B58

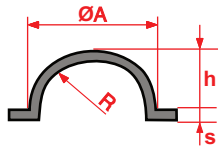
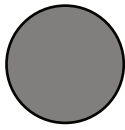

B59

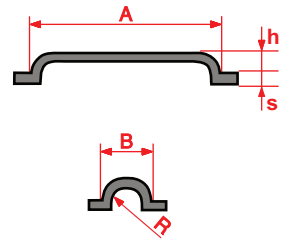

B60

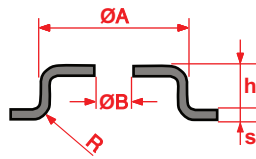
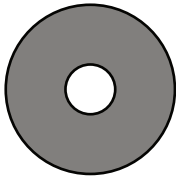

B61

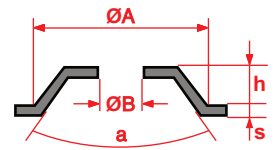
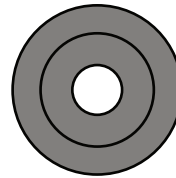

B62

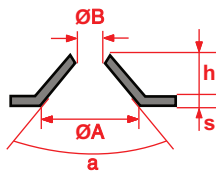
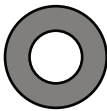

B63

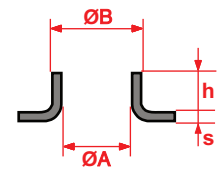
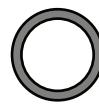

B64

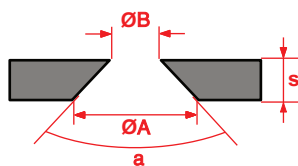
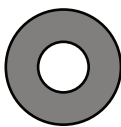

B65

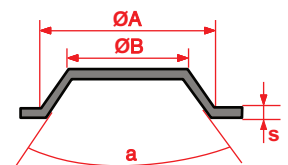
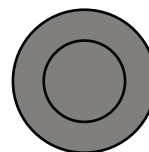

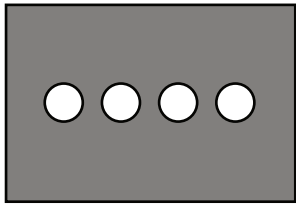

B100

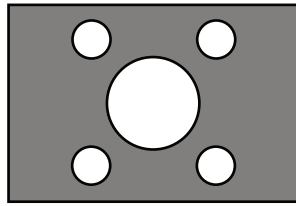

B101

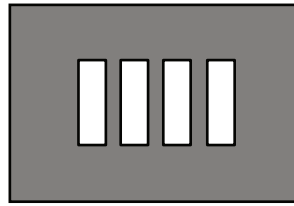

B102

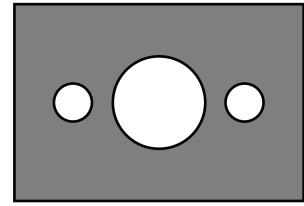

B103

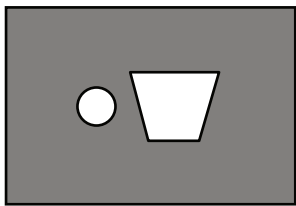

B104

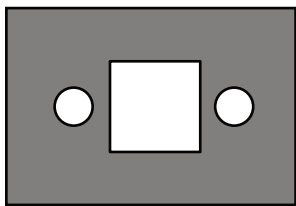

B105

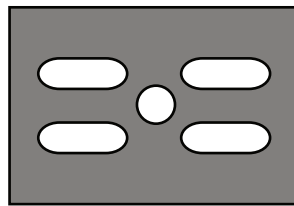

B106

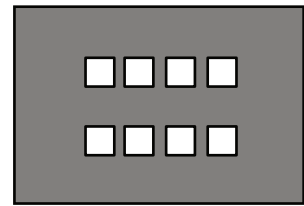

B107

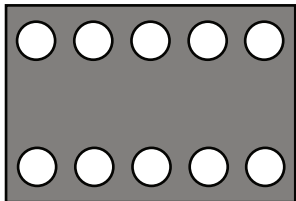

B108

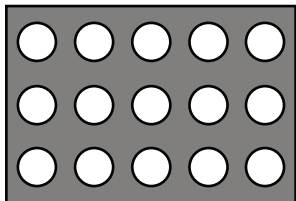

B109

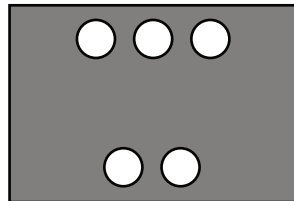

B110

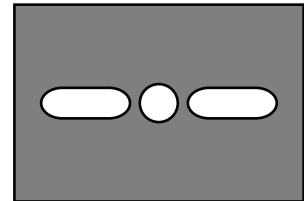

B111

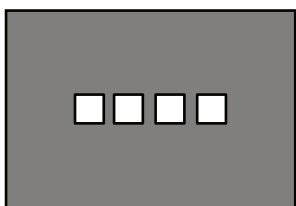

B112

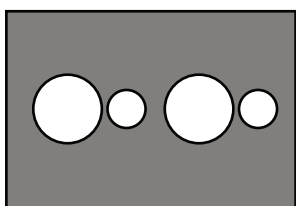

B113

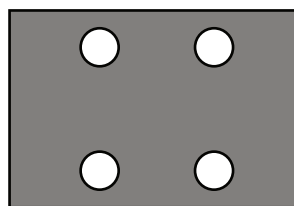

B114

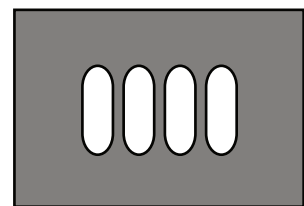

B115

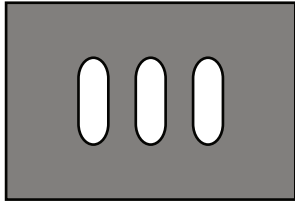

B116

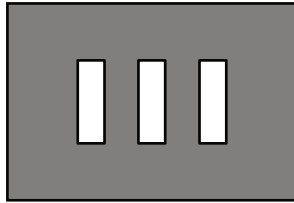

B117

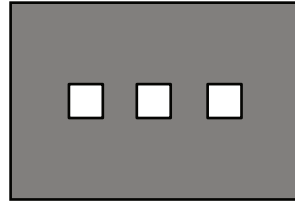

B118

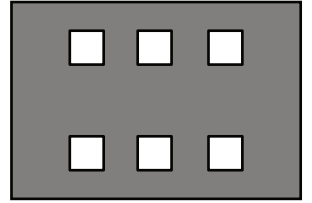

B119

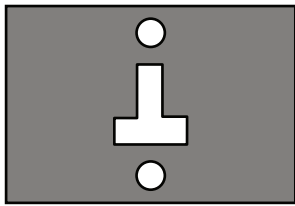

B120

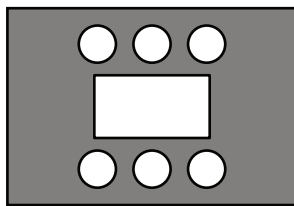

B121

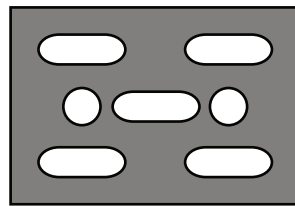

B122

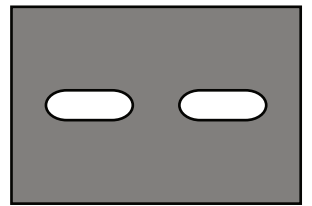

B123

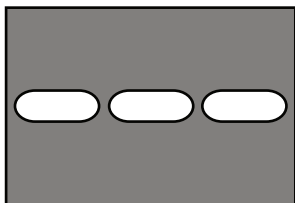

B124

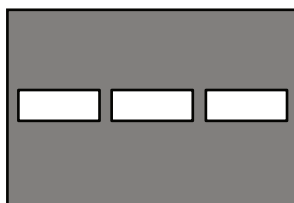

B125

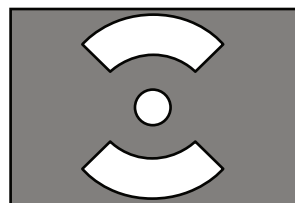

B126

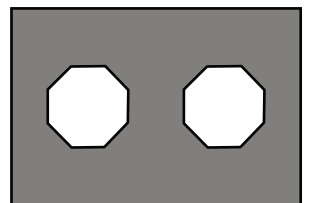

B127

TOLERANCIAS (mm) entre PUNZÓN y MATRIZ CLEARANCE (mm) between PUNCH & DIE

Espesores en mm. Thickness in mm	Hierro / Fe Mild Steel		Ac. Inox Stainless Steel		Aluminio Aluminium		Cobre / Latón Copper / Brass	
	Tolerancia Clearance	R	Tolerancia Clearance	R	Tolerancia Clearance	R	Tolerancia Clearance	R
0,5 - 0,6	0,08 - 0,10	0,10	0,10 - 0,12	0,12	0,06 - 0,08	0,08	0,05 - 0,06	0,06
0,8	0,14 - 0,15	0,15	0,15 - 0,20	0,20	0,10 - 0,14	0,10	0,08 - 0,10	0,08
1,0	0,16 - 0,20	0,20	0,18 - 0,24	0,24	0,12 - 0,16	0,14	0,10 - 0,14	0,12
1,2	0,20 - 0,24	0,24	0,25 - 0,30	0,26	0,15 - 0,20	0,16	0,12 - 0,15	0,14
1,5	0,25 - 0,30	0,30	0,27 - 0,35	0,34	0,18 - 0,24	0,22	0,15 - 0,20	0,18
2,0	0,34 - 0,40	0,40	0,36 - 0,45	0,45	0,24 - 0,30	0,26	0,20 - 0,25	0,24
2,5	0,45 - 0,50	0,50	0,46 - 0,55	0,55	0,32 - 0,35	0,35	0,25 - 0,30	0,28
3,0	0,50 - 0,60	0,60	0,60 - 0,70	0,65	0,35 - 0,45	0,40	0,30 - 0,40	0,36
4,0	0,65 - 0,80	0,80	0,70 - 0,95	0,90	0,45 - 0,60	0,55	0,40 - 0,50	0,48
5,0	0,85 - 1,00	1,00	0,90 - 1,15	1,10	0,60 - 0,80	0,70	0,55 - 0,65	0,60
6,0	0,95 - 1,20	1,20	1,10 - 1,40	1,35	0,75 - 0,95	0,85	0,70 - 0,85	0,72

R Recomendable
Recommended

RESISTENCIA AL CORTE TENSILE STRENGTH

Kg x mm²

Hierro Fe Mild Steel	Hierro Fe Mild Steel	Acero Inox. Stainless Steel	Aluminio Aluminium	Cobre Copper	Latón Brass
40 (0,1 % C)	50 (0,2 % C)	70	20	32	40

FÓRMULA PARA EL CÁLCULO DE TONELAJE (T) TONNAGE CALCULATION FORMULA (T)

$$\frac{P * n * t * Rc}{1000}$$

P = Perímetro (mm)
Perimeter (mm)

n = Número de punzones
Number of punches

t = Espesor de chapa (mm)
Sheet Thickness (mm)

Rc = Resistencia al Corte (Kgxmm²)
Tensile strength (Kgxmm²)

Rectificado de Punzón

A

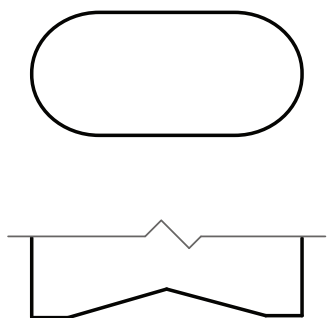

B

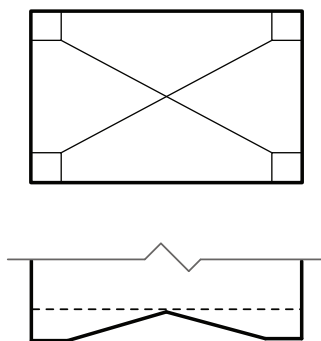

C

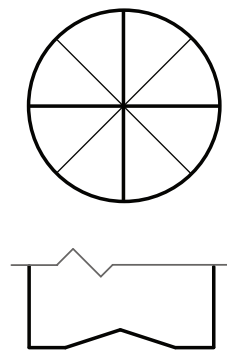

D

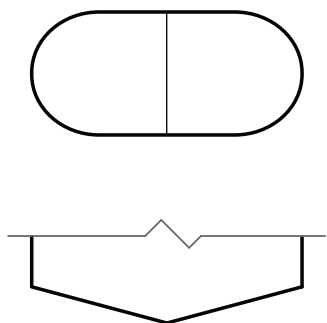

E

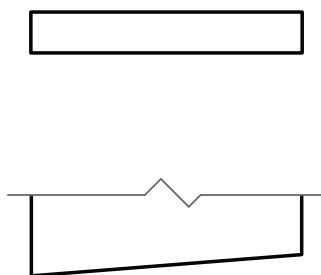

F

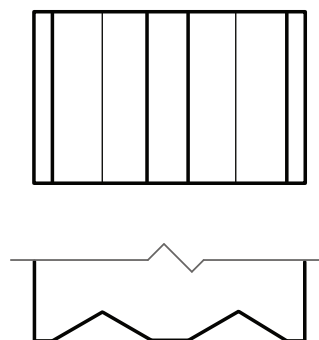

Tipo de Matriz

RR

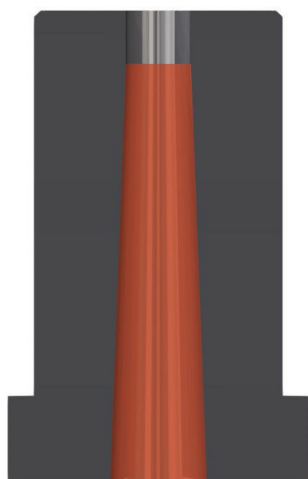

Matriz Estándar

R2C

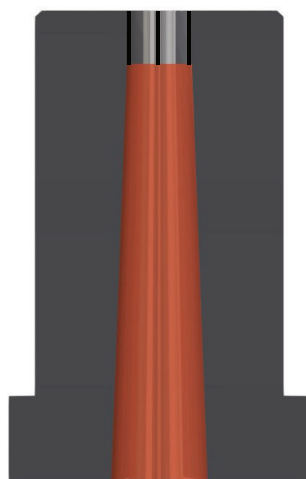

Matriz de Retención
por Filamentos

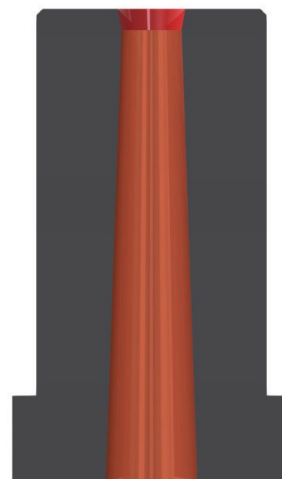

Matriz de Retención
por Dos Conos



DUR-TiN

- COLOR / COLOR: Amarillo oro / Yellow gold
- APLICACIONES / APPLICATIONS: General / General
- PROPIEDADES / PROPERTIES: Reduce el desgaste por abrasión y adhesión.
Reduces wear by abrasion and adhesion.

DUR-ALUM

- COLOR / COLOUR: Gris negro / Black grey
- APLICACIONES / APPLICATIONS: Aluminios, latón y derivados / Aluminium, brass and derivative
- PROPIEDADES / PROPERTIES: Reduce el desgaste por adhesión.
Reduces wear by adhesion.
Bajo coeficiente de fricción.
Low coefficient of friction.
Buenas propiedades de deslizamiento.
Good slip properties.

DUR-INOX

- COLOR / COLOUR: Gris violeta / Purple grey
- APLICACIONES / APPLICATIONS: Fe, galvanizados, Ac. inoxidables / Fe, Fe. galvanized and stainless steel
- PROPIEDADES / PROPERTIES: Relación optimizada entre dureza y tensión residual compresiva.
Optimized ratio between hardness and compressive residual stress.
Desgaste uniforme.
Uniform wear.
Buenas propiedades de deslizamiento.
Good slip properties.

DUR-EXTREM

- COLOR / COLOUR: Gris azulado / Bluish grey
- APLICACIONES / APPLICATIONS: General; recomendado para Ac. Inoxidable.
General; recommended to stainless steel.
- PROPIEDADES / PROPERTIES: Resistencia al desgaste muy elevada y excelente dureza en caliente.
Very high wear resistance and excellent hot hardness.
Muy buena estabilidad al choque térmico.
Very good stability to thermal shock.
Velocidad de corte notablemente más altas.
Higher cutting speed.

DUR-EXTREM PLUS

- COLOR / COLOUR: Cromo / Chrome
- APLICACIONES / APPLICATIONS: General; especialmente indicado para Ac. Inoxidable.
General; especially suitable to stainless steel.
- PROPIEDADES / PROPERTIES: La mayor dureza superficial.
The higher surface hardness.
Menor tendencia al calor.
Less heat tendency.
Mayor protección especialmente en los bordes contra el inicio y propagación de grietas.
Increased protection especially in the edges against the beginning and propagation of cracks.
Puede prolongar la vida útil del punzón hasta un 100%
Can extend punch life up to 100%.

AFILADO DE LOS PUNZONES

Como norma general, no se debería permitir que los punzones llegasen a necesitar un afilado mayor de 0,10 mm. Y sería óptimo rectificar en pasadas suaves (Z) de entre 0,01 y 0,02 mm. Estos parámetros indicarían un correcto mantenimiento de los punzones.

Para punzones con recubrimientos especiales: DUR-TiN, DUR-ALUM, DUR-INOX, DUR-EXTREM y DUR-EXTREM PLUS emplear los mismos indicadores; y dependiendo de la máquina que se utilice, rectificar con las más altas revoluciones de muela posibles y con avances entre 2.500 y 4.000 mm/min.

Una vez hecho el afilado del punzón, comprobar que la zona perimetral del corte ha quedado completamente limpia y no presenta gripado por adhesión de partículas del material punzonado, en caso de estas, limpiar esa zona con papel de lija fino hasta dejarla pulida.

SHARPENED OF PUNCHES

As general norm, it's not recommended sharpening punches more than 0,10mm. The correct form to sharp is doing it with smooth feeds (z) about 0,01 and 0,02mm. It will be the correct maintenance of the punches.

For punches with special coatings: DUR-TiN, DUR-ALUM, DUR-INOX, DUR-EXTREM and DUR-EXTREM PLUS, use the same indicators; using the highest revolutions of the grinding wheel for shapening, with feed rates between 2.500 and 4.000 mm/min.

Once realised the sharpened of the punch, verify that the peripheral zone of the cut is completely clean and if it's necessary polish the surface with a lightly stone.

Important: to avoid the heating of the pieces during the sharpening, always use a suitable coolant.

AFILADO DE MATRICES

Manteniendo las matrices en corte vivo, alargará la vida de los punzones, pues éstos no tendrán que embutir la chapa antes de ser cortada, se evitarán rebabas, ruido excesivo y se dejará una calidad correcta en el corte.

Sirven los mismos parámetros de muela, avances y pasadas tanto en el punzón como en la matriz; y antes de dar por bueno el afilado de la matriz, comprobar que en la parte interior del perímetro de corte, no han quedado restos de partículas de chapa adheridas, que vayan a friccionar con el puzón al iniciar de nuevo el trabajo.

Evitar el calentamiento de las piezas, usando siempre un refrigerante adecuado o taladrinas.

La energía producida por la fricción de la muela con los aceros, hará que estos hayan quedado ligeramente imantados; desmagnetizar las herramientas antes de iniciar el trabajo.

SHARPENED OF DIES

The correct maintenance of the dies will extend the life of punches, because these will not emboss the sheet before being cut, it will avoid burrs and excessive noise, and it give a correct quality of the cut.

For sharpening dies used the same procedures that with punches, feed rates and griding wheel, verify that the cut zone is completely clean of burrs and if it is necessary polish it to assure the correct work of the punch.

To avoid the heating of the pieces, always use a suitable coolant.

Demagnetize the resharpened tools before to start works.

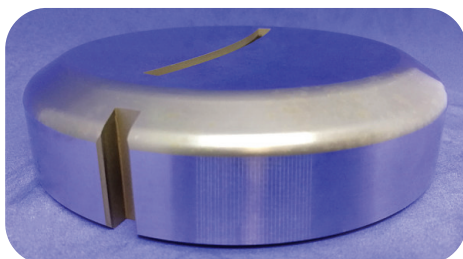

Servicio y Reparación

El servicio de reparación y ajuste de TC consiste en la comprobación, reparación, ajuste o modificación de cualquier componente fijo, móvil y/o accesorios de todo tipo de grupos de punzonado, matricería e incluso componentes de máquina sin importar marca y modelo.

Comprobación

Revisión de todos los elementos, comprobación de los mismos (medidas, chavetas, tornillo, etc.)

Reparación

Sustitución de cualquier elemento que interfiera en el buen funcionamiento del grupo, tanto por desgaste como por rotura.

Ajuste

Ajustamos los grupos para su correcto funcionamiento modificando alturas, recorridos, etc.

Modificación

Estudiamos la posibilidad de modificaciones y cambios en grupos de punzonado y matricería, realizando elementos nuevos y/o modificando los ya existentes.

Service & Repair

Tc's adjustment and repair consist of checking, repairing, adjusting, or modifying any fixed and mobile component and / or accessories of all types of punch groups, dies and even machine components of all brands.

Verification

Review all elements, checking them (measurements, keys, screws, ...).

Repair

Replacement of any element that interferes with the proper fuction of group for breakage and / or atrition.

Adjustement

We adjust the groups for their correct operation by modifying heights, courses, ...

Modification

We study the possibility of modifications and changes of punch groups and tooling, making new elements and / or modifying existing ones.





Solutions for Metalworking

www.tcpunzones.com

Euromac[®] system

Goiti[®] - Danobat[®] system

Thick Turret system

Trumpf[®] system

Salvagnini[®] system

Especiales y Accesorios

Plegadora

Láser

Tlf. +34 934 228 023
info@tcpunzones.com

